

NIKKEN

NC TOTAL TOOLING SYSTEM

NIKKEN

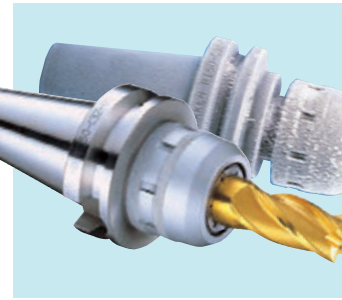
NC TOTAL TOOLING SYSTEM



NIKKEN KOSAKUSHO WORKS, LTD.
CAT.NO.303H

NIKKEN's Proposal for Improved Quality and Productivity.

Total management of M/C manufacturing methods & technologies.



HUMANWARE

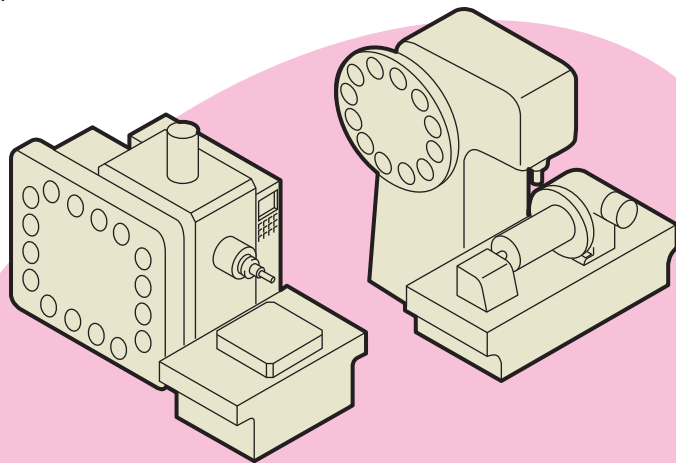
The effective utilization of M/C depends upon the insight and skill of shop floor people. Harmonization in the selection of machine, tooling, fixtures, peripherals, cutting tools under a coordinated shop floor management is the key to success.



COMBAT Z DRILL
P.255



REAMER SERIES
P.245

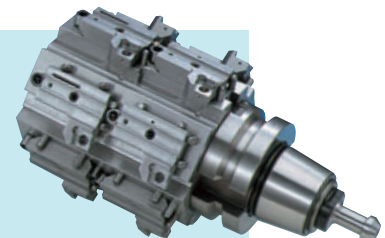
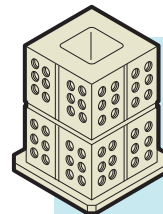


M/C OFFERS INVALUABLE OPPORTUNITIES FOR AUTOMATED, UNATTENDED MACHINING, when proper tooling, work holding and fixtures technologies are applied all in HARMONY.

CUTTING TOOLS

Relatively simple tools like drills and face mills also need careful attention for stable and effective swarf making. For instance, high speed steel tools can be more effective than carbide tools with certain work pieces and materials.

For another instance, why not a reamer for inspection/proof after boring?



FIXTURES

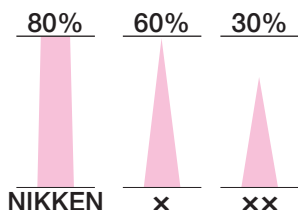
Work holding fixtures and power clamping systems for a variety of large or small batch work pieces.

Well designed fixtures can achieve cost effective parts manufacture. Fixtures (as shown above) effectively reduce ATC operations and drastically reduce cycle time.

TOOLING

MORE THAN 80% TAPER CONTACT is needed for this vital linkage between machine and workpiece. ;

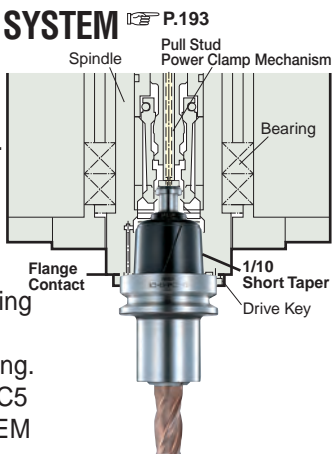
- ① NIKKEN holders protect the spindle. (They eliminate "dance" in the spindle.)



- ② NIKKEN milling chucks are SUB-ZERO TEMPERATURE (-90°C) TREATED for stable particle composition : Heat treated to HRC60.

The Next Generation Tool Interface NC5 TOOLING SYSTEM

This newly developed Tool Interface featured. A Double Contact 1/10 Short Taper for improved High Speed & High Precision Machining and High Stock Removal Machining. Please refer to NC5 TOOLING SYSTEM catalogue.



PERIPHERALS

AUTOMATIC WORK CHANGER
Operator-friendly AWC system for vertical machining centres.

CNC ROTARY TABLES
Precision worm screw made of solid tungsten carbide drives hardened and ionnitrided worm wheel made of steel.

THE ONE AND ONLY SOLUTION FOR ELIMINATING SPOT WEAR.



KOKORO = Human Heart

Our company name "NIKKEN" is derived from a desire of "Always keeping the attitude of mind for patient daily study and contributing to future industry with technology and idea".

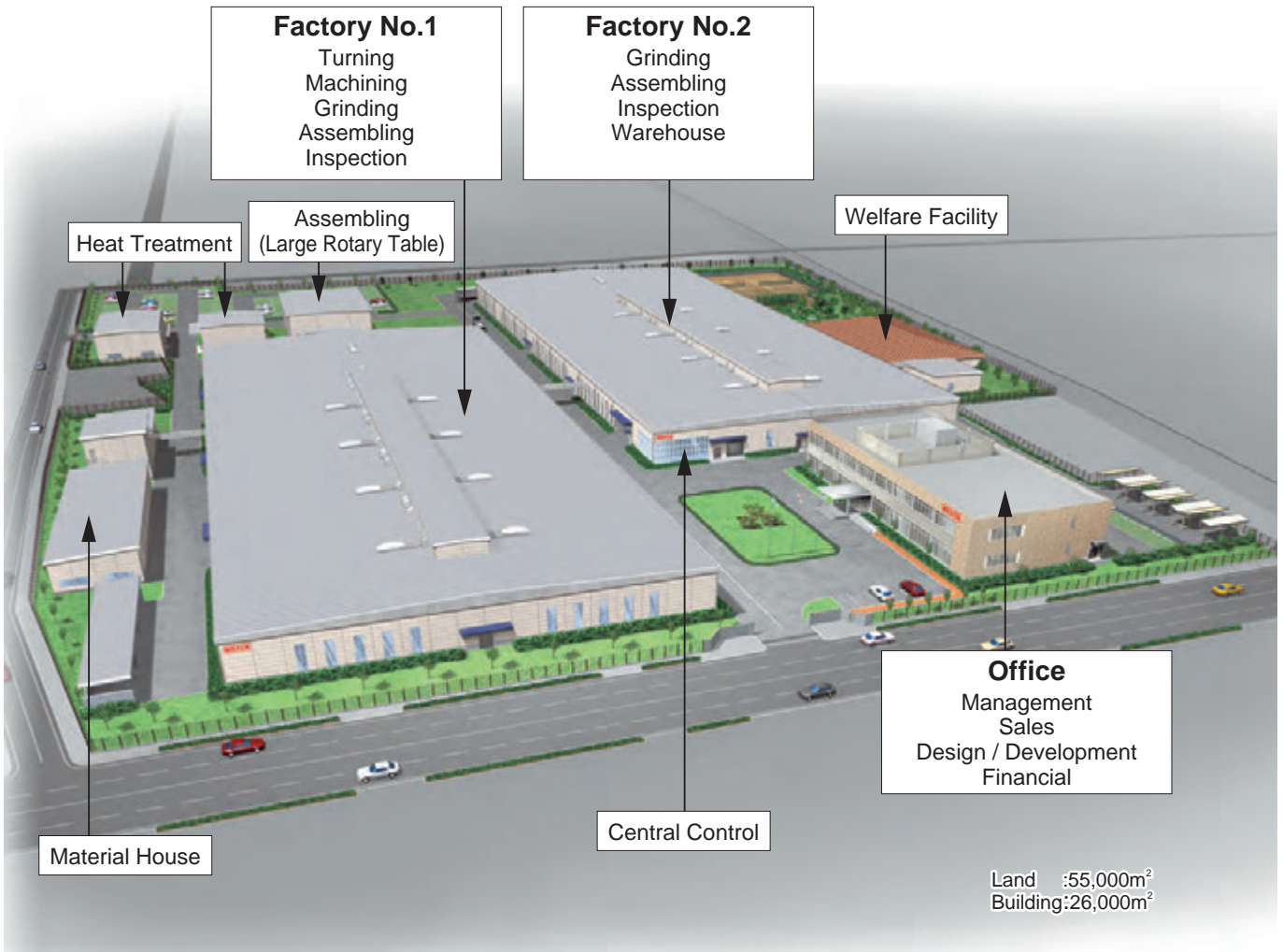
Pursuing the development and production of tools for 50 years, we have developed peripheral instrument such as NC toolings, Mill reamers, CNC Rotary Tables and Controllers (NIKKEN-Ø21 series) etc. conforming to customers demands.

Today's effort and study will bring about large tomorrows fruits. NIKKEN wishes to provide you with original products of the highest quality on the basis of every day study.



OSAKA-DAITO NEW OFFICE & FACTORY
LAND:55,000m²
BUILDING:26,000m²

OSAKA·DAITO Office & Factory



Carbonizing & Sub-Zero Treatment

NIKKEN is the only tooling product manufacturer which performs sub-zero treatment for tooling. This refers to a technique where -90 deg. ultra-low-temperature processing is performed after carbonizing and quenching in order to eliminate the residual austenite and to form 100% martensite compositions to prevent deterioration over time. This technique has been applied for block gauges and for bearings of the highest grade in the past. It is an example of how **NIKKEN** pays attention to those aspects which are often hidden from view and how we put our hearts and souls into each and every tooling product.




Ion Nitriding

Ion nitriding refers to a nitriding process where glow discharges are generated in a vacuum of a nitrogen-mixed gas atmosphere to heat the workpieces at a low temperature of 450 deg. while at the same time nitriding them by a sputtering action. This processing improves both the wear resistance and sliding performance.(It reduces the surface friction coefficient.)The experience and know-how of ion nitriding have been utilized in a large number of **NIKKEN**'s products, including worm wheels for CNC Rotary Tables and Tough-Cut Skill Reamers.



NC Lathe Line

NIKKEN Oil Jetter System and **Combat Z Drill**  **P.255** resolved the problems from the cooling of the cutting edge and the swarf removal, then, night time un-manned operation could be done.

M/C Line

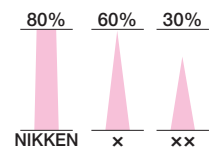
The M/Cs with **3Lock** spindle and **NC5** spindle are working with high accuracy and high productivity through the night.



Tool Grinding Line

More than 80% Taper Contact is needed for this vital linkage between M/C and workpiece.

NIKKEN holders protect the spindle.
(They eliminate "dance" in the spindle.)



Reamer Grinding Line

Reamer grinding line to seek the ultimate unmanned operation with high accuracy and high productivity.



RADICAL MILL REAMER



CNC Rotary Table Assembling Line

NIKKEN builds the most rigid, precise and durable CNC Rotary Table for the worldwide manufacturing market.

INDEX

FEATURES

MULTI LOCK MILLING CHUCK	9
MINI MINI CHUCK	11
SLIM CHUCK	12
MAJOR DREAM HOLDER	13
VC HOLDER	14
NC DRILL CHUCK & TAPPER CHUCK	14
DJ BORING HEAD	16
BALANCE CUT BORING BAR	17
ZMAC BORING BAR	18

DIMENSIONS

MILLING CHUCK	29
HIGH SPEED MILLING CHUCK	30
GH HANDLE	30
Straight Shank TOOL for MILLING CHUCK	31
STRAIGHT COLLET	31
CENTRE COOLANT COLLET	32
MINI-MINI CHUCK	33
MINI MINI CHUCK COLLET	33
VC HOLDER	34
VC HOLDER COLLET	34
MAJOR DREAM HOLDER	35
A TYPE SLIM COLLET	36
SLIM CHUCK	37
SLIM COLLET	39
A TYPE SLIM COLLET for END MILL SHANK	39
Straight Shank SLIM CHUCK	40
HIGH SPEED SLIM CHUCK (STRAIGHT)	41
TIN BEARING NUT	43
J TYPE NUT & CAP	43
ADJUST SCREW for SLIM CHUCK	44
NC DRILL CHUCK	45
JACOBS TAPER ADAPTER	45
SIDE LOCK HOLDER for END MILL	46
SIDE LOCK HOLDER for DRILL	46
DSA DRILL SOCKET	46
MORSE TAPER ADAPTER A type	47
MORSE TAPER ADAPTER B type with draw bolt	48
NT50 SHANK SLEEVE for NT40 TOOL	48
TAPPER CHUCK	50
AUTO. DEPTH CONTROL TAPPER CHUCK	49
TAP COLLET (ISO, IMPERIAL, DIN)	51
TAP COLLET (JIS)	53
LONG SIZE TAP COLLET	55
AUTO. REVERSING TAPPER CHUCK	56
SYNCHRONIZED TAPPING HOLDER	57
TAP COLLET without TORQUE CONTROL	58
BORING SYSTEM	59
BALANCE CUT BORING ARBOR RAC-E	61
RAC	63
RAC-A	65
RAC-K	67
RAC BORING HEAD	69
CARTRIDGE for RAC BORING HEAD	70
BALANCE CUT BORING ARBOR for LARGE DIA RAC	71
BALANCE CUT BORING ARBOR for LARGE DIA RAK	72
BALANCE CUT PLATE for LARGE DIA RPC	72
ACCESSORIES for BALANCE CUT BORING BAR RCC	72
ZMAC BORING BAR ZMAC	73
ZMAC BORING BAR ZMAC-R	75
ZMAC BORING HEAD ZMAC	77
ZMAC BORING HEAD ZMAC α	78
BALANCE CUT BORING ARBOR for LARGE DIA BAC	79
BALANCE CUT BORING ARBOR for LARGE DIA BCB	80
ACCESSORIES for BALANCE CUT BORING BAR MCCZ, BCB	81
SPECIAL DESIGNED BORING ARBOR	82
DJ BORING BAR DJ	83
DJ BORING HEAD DJ	83
BORING BIT for DJ J	84
BT Shank BASE HOLDER for MODULAR type	85
SPACER for MODULAR type	86
MAJOR DREAM BASE HOLDER for MODULAR type	87

ZERO FIT HOLDER	19
FOUBLE FACE CONTACT TOOLING	20
FACTORY AUTOMATION SERIES	21
MULTI OIL HOLE HOLDER & COMBAT Z DRILL	23
REAMER SERIES	24
MEASURING ATTACHMENT	25
TOOL PRESETTER	26
CNC ROTARY TABLE	27

Straight Shank BASE HOLDER	87
MICRO CUT BORING HEAD	88
Straight Shank BALANCE CUT BORING BAR RAC	89
Straight Shank ZMAC BORING BAR	89
Straight Shank DEEP HOLE ZMACX BORING BAR	90
Straight Shank DJ BORING BAR	91
Straight Shank MICRO-CUT BORING BAR	88

BALANCE CUT BORING UNIT PARTS LIST	92
ZMAC UNIT PARTS LIST	93
BCB UNIT PARTS LIST	94

CUTTING CONDITION of BALANCE CUT BORING BAR RAC	95
CUTTING CONDITION of ZMAC BORING BAR	96
CUTTING CONDITION of DJ BORING BAR	97

INSERT TIP	98
BORING BAR for SQUARE & CYLINDRICAL BORING TOOL	100

FACE MILL ARBOR (JIS)	101
FACE MILL ARBOR	101
SHOULDER CUTTER ARBOR	102
SHELL END MILL ARBOR	102
PRO-END MILL	103
STUB ARBOR	104

CENTRE THROUGH TOOL COOLANT HOLDER	105
FLANGE THROUGH TOOL COOLANT HOLDER	107

RPT TREATMENT	106
---------------	-----

MULTI OIL HOLE HOLDER	109
MILLING CHUCK type MULTI OIL HOLE HOLDER	109
SLIM CHUCK type MULTI OIL HOLE HOLDER	109
SIDE LOCK type MULTI OIL HOLE HOLDER	110
MORSE TAPER type MULTI OIL HOLE HOLDER	110
AUTO. DEPTH CONTROL TAPPER CHUCK for OIL HOLE TAP	110
TAP COLLET for OIL HOLE TAP	110
OIL HOLE HOLDER	111

HIGH SPEED SPINDLE SPEEDER	112
SUPER HIGH SPEED SPINDLE SPEEDER	112

AIR TURBINE SPINDLE TOOL	112
AIR MOTOR SPINDLE TOOL	113

ANGULAR HEAD SYSTEM	114
QUICK CHANGE type ANGULAR HEAD	115
ADAPTER for QUICK CHANGE type ANGULAR HEAD	116
MODULAR type ANGULAR HEAD	117
ADAPTER for MODULAR type ANGULAR HEAD	117
SOLID - OFF-SET type ANGULAR HEAD	118
SOLID 90°, 45° type ANGULAR HEAD	118
ANGULAR HEAD for DEEP HOLE	117
DIRECT MOUNT FLANGE type ANGULAR HEAD	119
MULTI SPINDLE HEAD SERIES	119

ZERO FIT TYPE MILLING CHUCK	120
ZERO FIT TYPE SLIM CHUCK	120
HOW TO ADJUST A RUN-OUT	156

AUTOMATIC BACK SPOT FACING ARBOR	121
MANUAL BACK SPOT FACING ARBOR	121
SPINDLE TAPER CLEANER	153
AUTOMATIC OIL SUPPLY HOLDER	153

IT TOOLING SYSTEM	123
IT MILLING CHUCK	123

IT MINI-MINI CHUCK	124
IT SLIM CHUCK	124
IT VC HOLDER	125
IT MAJOR DREAM HOLDER	125
IT ZERO FIT TYPE MILLING CHUCK	126
IT ZERO FIT TYPE SLIM CHUCK	126

UNIVERSAL MICRO TOUCH UMT	127
UNIVERSAL MICRO TOUCH UMTX	128
TOUCH POINT TP	129
UNIVERSAL MICRO STAND UDS	130
HEIGHT PRESETTER HP	131
CENTERING HOLDER SY	132
BALL CENTRALIZER BAL	132
TEST BAR TB	133
TOOL CLAMPER NCL	134
HSK TOOL CLAMPER TCL-GH	218

TOOL PRESETTER E236N	133
TOOL PRESETTER E238-MBT	135
TOOL PRESETTER E450N	136
TOOL WAGON	134
TOOL PRESETTER NTP series	137
TMS SYSTEM	138

3LOCK SYSTEM	139
3LOCK TECHNICAL INFORMATION	140
BT DOUBLE FACE CONTACT SPINDLE	140
MBT MILLING CHUCK	141
MBT SLIM CHUCK	143
MBT MINI-MINI CHUCK	146
MBT VC HOLDER	146
MBT ZMAC BORING BAR	147
MBT BALANCE CUT BORING BAR	148
MBT MODULAR type BORING BASE HOLDER	149
MBT DJ BORING BAR	149
MBT BALANCE CUT BORING ARBOR for LARGE DIA	150
MBT FACE MILL ARBOR	151
MBT ZERO FIT type MILLING CHUCK	152
MBT ZERO FIT type SLIM CHUCK	152
3LOCK SPINDLE FLANGE CLEANER	153

MIT TOOLING SYSTEM	154
MIT MILLING CHUCK	154
MIT MINI-MINI CHUCK	155
MIT SLIM CHUCK	155
MIT VC HOLDER	156
MIT FACE MILL ARBOR	157

2LOCK SYSTEM	158
NBT MILLING CHUCK	159
NBT HIGH SPEED MILLING CHUCK	160
NBT MINI-MINI CHUCK	162
NBT SLIM CHUCK	163
NBT HIGH SPEED SLIM CHUCK (TAPER)	165
NBT HIGH SPEED SLIM CHUCK (STRAIGHT)	166
NBT VC HOLDER	168
NBT MAJOR DREAM HOLDER	169
NBT MAJOR DREAM PRO ENDMILL	171
NBT MAJOR DREAM SHRINK FIT HOLDER	172
NBT ZERO FIT type MILLING CHUCK	173
NBT ZERO FIT type SLIM CHUCK	173
NBT NC DRILL CHUCK	174
NBT SIDE LOCK HOLDER	174
NBT MORSE TAPER ADAPTER A type	175
NBT MORSE TAPER ADAPTER B type	175
NBT TAPPER CHUCK	176
NBT ZMAC BORING BAR	177
NBT BALANCE CUT BORING BAR	178
NBT MAJOR DREAM MODULAR type BORING BASE HOLDER	178
NBT MODULAR type BORING BASE HOLDER	179
NBT DJ BORING BAR	179
NBT BALANCE CUT BORING ARBOR for LARGE DIA	180
NBT FACE MILL ARBOR	181
NBT STUB ARBOR	183
NBT HIGH SPEED SPINDLE SPEEDER	184
NBT ANGULAR HEAD	185
NBT FLANGE THROUGH TOOL COOLANT HOLDER	187

NIT MILLING CHUCK	189
NIT MINI-MINI CHUCK	190
NIT SLIM CHUCK	190
NIT VC HOLDER	191
NIT MAJOR DREAM HOLDER	191
NIT FACE MILL ARBOR	192

NC5 TOOLING SYSTEM	193
NC5 MILLING CHUCK	195

NC5 SLIM CHUCK	197
NC5 VEGA CHUCK	199
NC5 VC HOLDER	199
NC5 ZERO FIT type MILLING CHUCK	200
NC5 ZERO FIT type SLIM CHUCK	200
NC5 NC DRILL CHUCK	201
NC5 SIDE LOCK HOLDER	201
NC5 MORSE TAPER ADAPTER A type	202
NC5 STUB ARBOR	202
NC5 TAPPER CHUCK	202
NC5 ZMAC BORING BAR	203
NC5 BALANCE CUT BORING BAR	204
NC5 BALANCE CUT BORING ARBOR for LARGE DIA	205
NC5 MODULAR type BORING BASE HOLDER	206
NC5 FACE MILL ARBOR	206
NC5 TAPER GAUGE	207
NC5 TEST BAR	207

HSK TOOLING SYSTEM	208
HSK MILLING CHUCK	209
HSK SLIM CHUCK	213
HSK MAJOR DREAM HOLDER	217
HSK VC HOLDER	218
HSK MINI-MINI CHUCK	218
HSK MAJOR DREAM PRO ENDMILL	219
HSK MAJOR DREAM SHRINK FIT HOLDER	220
HSK ZERO FIT type MILLING CHUCK	221
HSK ZERO FIT type SLIM CHUCK	221
HSK TEST BAR	222
HSK LUBRICATION PIPE	222
HSK NC DRILL CHUCK	223
HSK SIDE LOCK HOLDER	223
HSK STUB ARBOR	224
HSK TAPPER CHUCK	224
HSK FACE MILL ARBOR	225
HSK MORSE TAPER ADAPTER A type	225
HSK BALANCE CUT BORING ARBOR	227
HSK BALANCE CUT BORING ARBOR for LARGE DIA RAC	235
HSK ZMAC BORING BAR	237
HSK BALANCE CUT BORING ARBOR for LARGE DIA BAC	241
HSK BASE HOLDER for MODULAR type	243
HSK DJ BORING BAR	244
HSK MAJOR DREAM style BASE HOLDER	244

REAMER SERIES	245
CARBIDE PF RADICAL REAMER	246
CARBIDE PF RADICAL MILL REAMER	246
CARBIDE MILL REAMER	247
CARBIDE BROACH REAMER	249
BROACH REAMER	250
TOUGH CUT SKILL REAMER	251
NC SENSOR REAMER	253
RIGHT HAND HELICAL REAMER	254

COMBAT Z DRILL	255
-----------------------	-----



CNC ROTARY TABLE	257
-------------------------	-----

PULL STUD	261
PULL STUD (CENTRE THROUGH COOLANT)	262
PULL STUD with ID	261
PULL STUD (DRAW BOLT type)	48
PULL STUD CODE NO.	263
CLAMPING FORCE MEASURING TOOL	261

TECHNICAL INFORMATION for STOPPER PIN	265
TECHNICAL INFORMATION for STOPPER BLOCK	266

DIMENSIONS of BT and IT	267
DIMENSIONS of HSK	268
DIMENSIONS of NC5	207
ALPHABETICAL INDEX	271
CAUTION	274

WORLD WIDE SALES BRANCH	277
NIKKEN CHINA	278
LYNDEX-NIKKEN (NIKKEN USA)	279
NIKKEN EUROPE (NIKKEN UK)	280
NIKKEN DEUTSCHLAND (NIKKEN GERMANY)	281
PROCOMO-NIKKEN (NIKKEN FRANCE)	282

NIKKEN is keeping the manufacturing not only the quality, but also the safety in mind. Please be careful for the content marked  .
e.g.  **P.274 CATION**

NIKKEN NC TOOLING SYSTEM

BT

3Lock

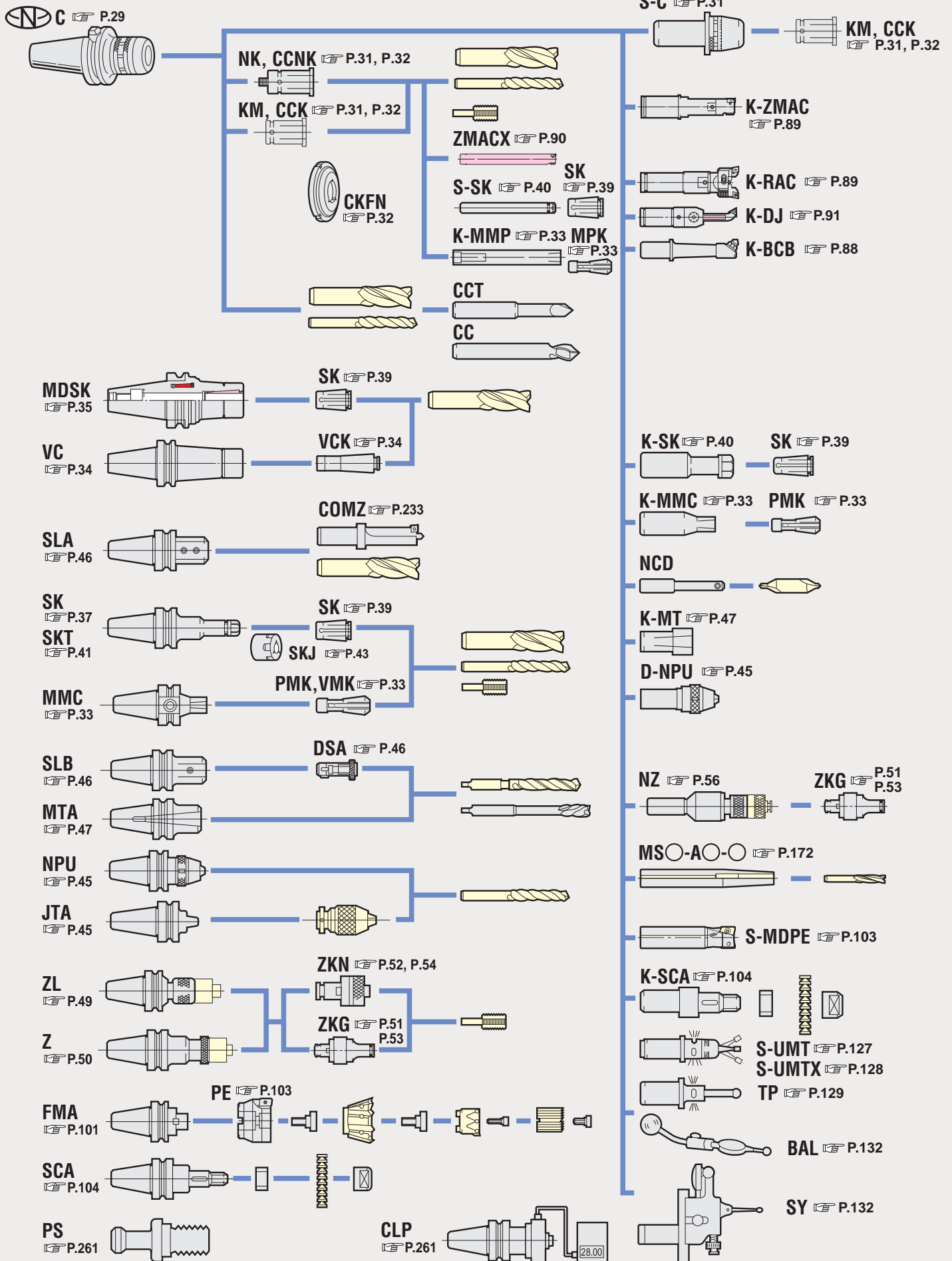
2Lock

NC5

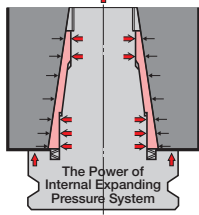
HSK

REAMER-DRILL

MEASUREMENT



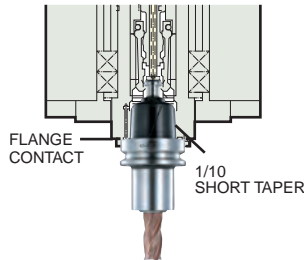
NEXT GENERATION TOOL INTERFACE



The Power of Internal Expanding Pressure System

3LOCK SYSTEM P.139

2LOCK SYSTEM P.158

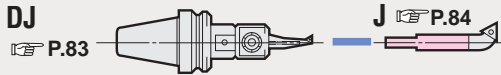


NC5 TOOLING SYSTEM P.193

ISO·DIN

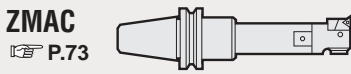
IT TOOLING SYSTEM P.123

HSK TOOLING SYSTEM P.208

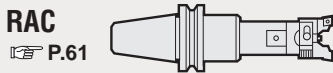


DJ P.83

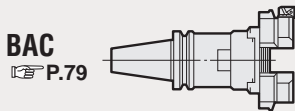
J P.84



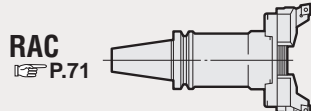
ZMAC P.73



RAC P.61



BAC P.79

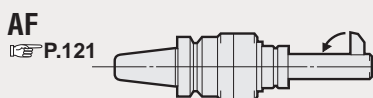


RAC P.71

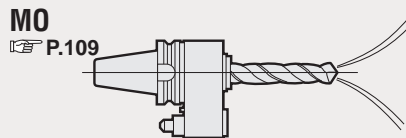
Insert Tip P.98



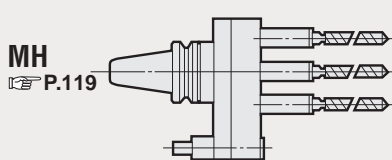
NX, PX, HTS P.112



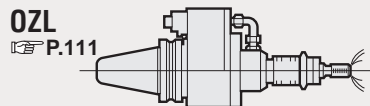
AF P.121



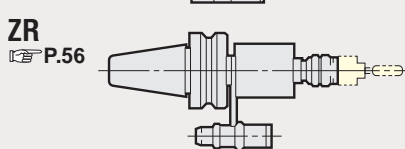
MO P.109



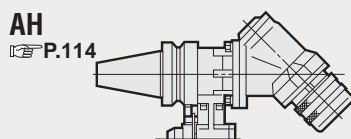
MH P.119



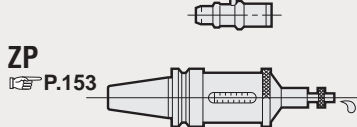
OZL P.111



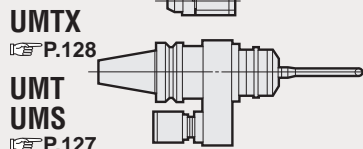
ZR P.56



AH P.114



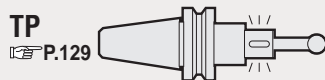
ZP P.153



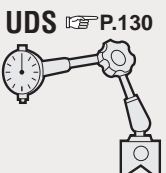
UMTX P.128



UMT
UMS P.127



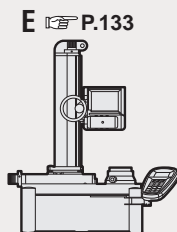
TP P.129



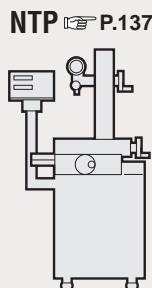
UDS P.130



HP P.131

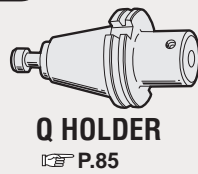


E P.133



NTP P.137

SP P.86



Q HOLDER P.85



DJ P.83



ZMAC P.77

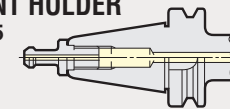


BCB P.88

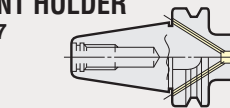


RAC P.69

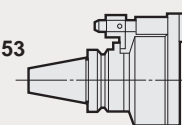
CENTRE THROUGH COOLANT HOLDER P.105



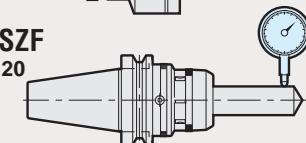
FLANGE THROUGH COOLANT HOLDER P.107



CLE P.153



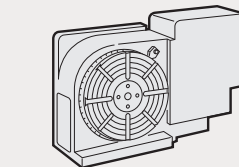
CZF, SZF P.120



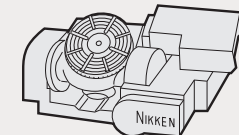
REAMER P.245



COMBAT Z DRILL P.255



CNC P.257





"ANNIVERSARY"
type

MULTI LOCK MILLING CHUCK

It has been 45 years since NIKKEN developed the MULTI-LOCK MILLING CHUCK, NIKKEN's technology has developed the new generation universal chuck.

We call this MULTI -LOCK MILLING CHUCK "ANNIVERSARY" type. 松本 駿一



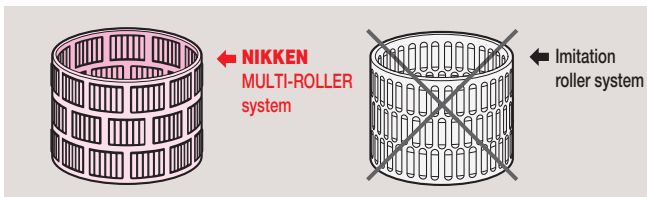
Sub-zero Treatment

NIKKEN Toolings are all subjected to ultra-low temperature treatment of -90°C after carburizing, as shown. This treatment removes residual austenite to prevent from deformation for many years. Thus all of our NIKKEN toolings are produced one by one with greatest possible care of NIKKEN spirits.



1 Chucking Torque and Durability

All the NIKKEN MULTI-LOCK Milling Chucks incorporate the multi-roller system including **140% more needle rollers** than the other imitations. Besides, the retainer is not made of phosphor bronze but of special steel which will never break.



As seen from the cross sectional view, the needle rollers are arranged in perfect order with a dense production, but they are arranged to be scattered in the imitations.



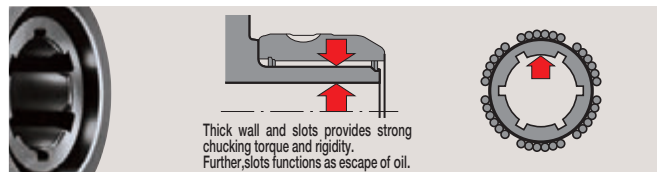
The larger quantity of needle rollers enables the moving of the same load with a small force and less damage on the bearing surface, thus providing a stronger chucking torque without creating even rolling when tightening.

2 Rigidity and Chucking Torque

Internal slots together with thickened wall of chuck body ensure no distortion even at heavier milling. Thus, smooth milling work is attained without the vibration or slipping of end mill.

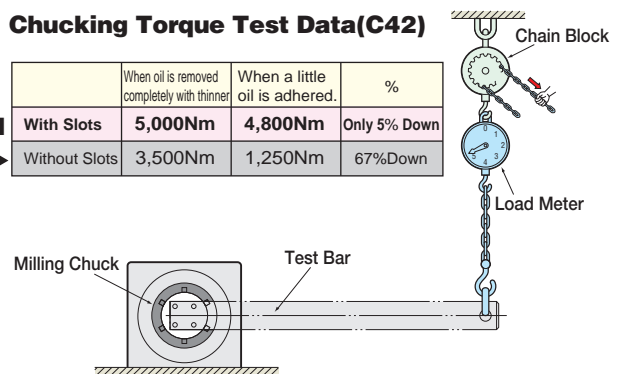
Effects of Internal Slots

Thanks to internal slots, even if oil remains on the end mill shank, there is no decreasing of chucking torque. In case of imitations without slots, chucking torque is largely reduced by oil, causing the shank to slip down.



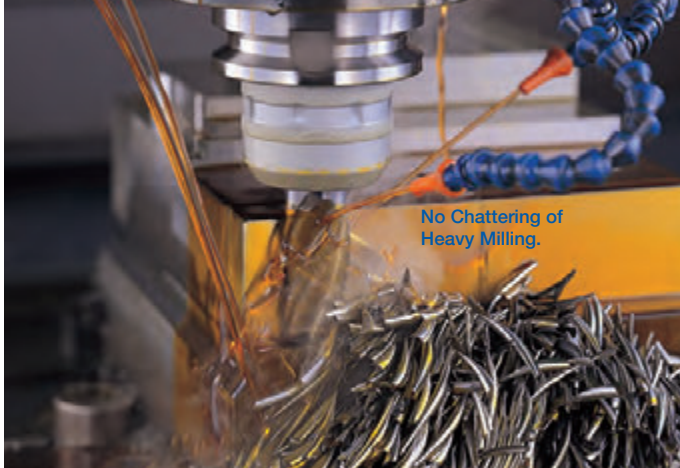
Chucking Torque Test Data(C42)

	When oil is removed completely with thinner	When a little oil is adhered.	%
NIKKEN With Slots	5,000Nm	4,800Nm	Only 5% Down
Others Without Slots	3,500Nm	1,250Nm	67%Down





Same Appearance,
but a Remarkable Improvement can be found when cutting.



JAPAN, USA, FRANCE, ITALY, SPAIN PAT.
KOREA, TAIWAN

3 New Clamping at Root & Anti-Vibration Mechanism

Cutting Data HSS Endmill-Carbide Endmill

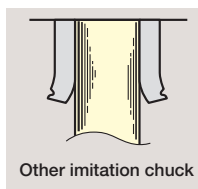
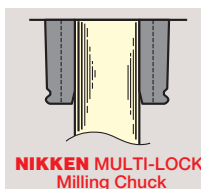
CHUCK	ENDMILL	CUTTING CONDITION	AdxRd
BT50-C32-90	HSS Coating 32φ4t	V 38m/min S 380min ⁻¹ F 152mm/min	S55C 60mm OIL 12mm
BT50-C42-95	HSS Roughing 42φ 45φ6t	V 30m/min S 210min ⁻¹ F 130mm/min	S55C 110mm OIL 20mm
BT50-C20-135 KM20-16	Carbide Coating 16φ4t	V 176m/min S 3,500min ⁻¹ F 2,000mm/min	S55C 35mm 3mm
BT40-C25-70	HSS Coating 25φ4t	V 38m/min S 480min ⁻¹ F 192mm/min	S55C 50mm OIL 8mm
BT40-C16-60	Carbide Coating 16φ4t	V 200m/min S 4,000min ⁻¹ F 2,000mm/min	S55C 30mm 3mm
BT30-C12-55 KM12-10	Carbide Coating 10φ4t	V 160m/min S 5,000min ⁻¹ F 2,000mm/min	S50C 15mm 3mm
BT30-C12-55	HSS Non Coating 12φ4t	V 30m/min S 800min ⁻¹ F 250mm/min	S50C 18mm WATER 4mm
		V 228m/min S 6,000min ⁻¹ F 3,600mm/min	ALUMINIUM 20mm WATER 3mm

The End Mill can perform at 100% of their capability by using the cutting data. If cutting condition is exceeded, they may cause tool failure. For the M/C with ball guide mechanism, MAJOR DREAM HOLDER might perform better than MULTI-LOCK milling chuck.

4 Clamping at Nose Mechanism

Clamping at nose - key Condition for Precise Milling.

Surface Finish and Tool Life are decided by Clamping at Nose, Rigidity and Run-Out Accuracy. Only our mechanism performs real clamping at nose, never rivalled by imitations : ideal for heavy milling to fine finishing. Only the NIKKEN MULTI-LOCK Milling Chuck perfectly clamps even at 3mm from chuck nose.

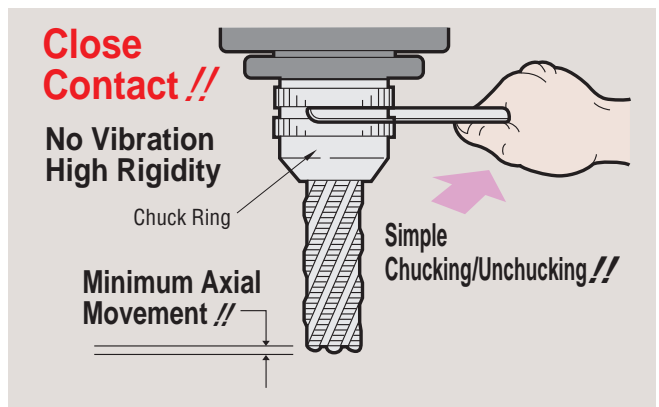


5 Stable Milling with Stopper

Easy for "anyone to attain a stable torque."

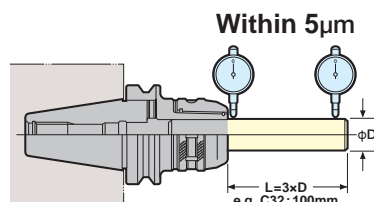
Wear of the bearing surface is only 1~2microns even after practical use of 4~5years owing to the use of 140% more needle rollers than imitations, the use of special material (steel) of NIKKEN own. and the know-how of hardening. The stopper is therefore located to the MULTI-LOCK Milling Chuck where the maximum efficiency of chucking torque is exerted. Tightening the chuck close to the flange face gives a sign of "MILLING OK" to ensure smooth, stable and reliable milling work.

(Important : Good production with Assurance!!)



6 Fine Run-Out Accuracy

Only NIKKEN MULTI-LOCK Milling Chuck can obtain the run-out accuracy within 5μm(T. I. R) at the position 100mm apart from the nose.(C32 Style)



High Speed·High Precision Best Chuck for Small Diameter Cutting Tool

2LOCK tooling can be used as the BT double face contact tooling on the machine with the BT double face contact spindle. It can be also used as the BT tooling on the machine with BT standard spindle.



PAT.

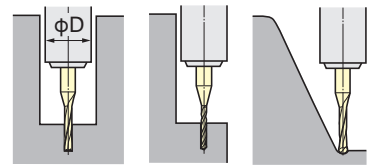
High Speed

MAX. 30,000min⁻¹ & G2.5

Several hundreds of this Holder are already appreciated and used in One Aircraft Parts Manufacturer in USA. We highly recommend this Holder.

Slim & Compact

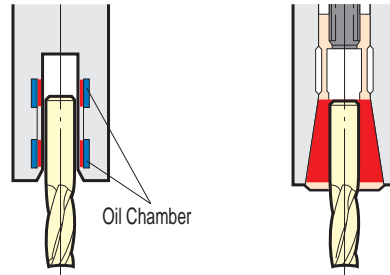
- MMC 4 : ϕ 15mm
- MMC 8 : ϕ 20mm
- MMC12 : ϕ 30mm



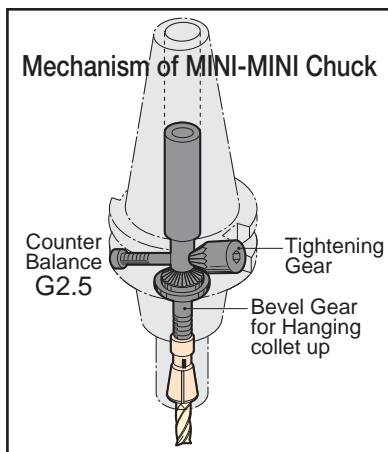
Gripping from Front Nose

✗
HYDRAULIC CHUCK
No Gripping at Front Nose
Gripping Torque?

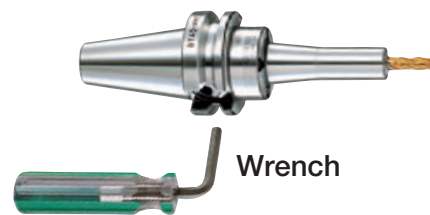
○
MINI-MINI CHUCK
Gripping from Front Nose
Powerful Gripping Torque/3times



Mechanism of MINI-MINI Chuck



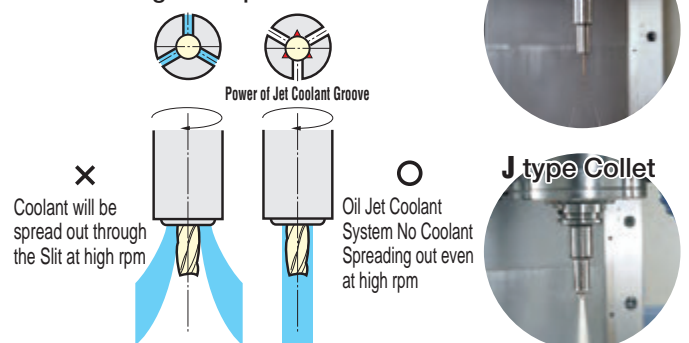
“Pull up & Chucking” Can be done with Only One Wrench.



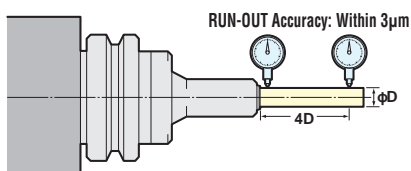
Coolant Through Tool Capability

J type Collet + End Mill
High Pressure Coolant
Through Jet Spread Groove

Standard Collet



RUN-OUT Accuracy: Within 3 μ m



HIGH SPEED ROTATION·HIGH ACCURACY·HIGH PRESSURE COOLANT THROUGH
Power of TiN BEARING NUT

TiN Bearing Nut is used for Nikken Slim Chuck, MAJOR DREAM Holder and VC Holder with great popularity.

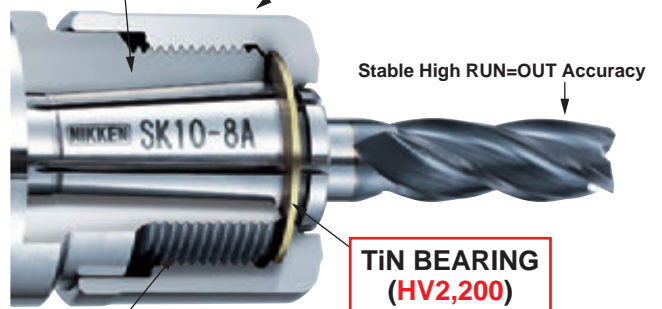


High Speed Slim Chuck
MAX. 40,000min⁻¹ & G2.5

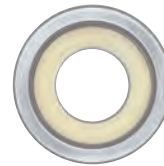
Power of TiN Bearing Nut

8 degree Taper Collet for Accuracy & Gripping Torque

Simple & Compact Design for High Speed Rotation



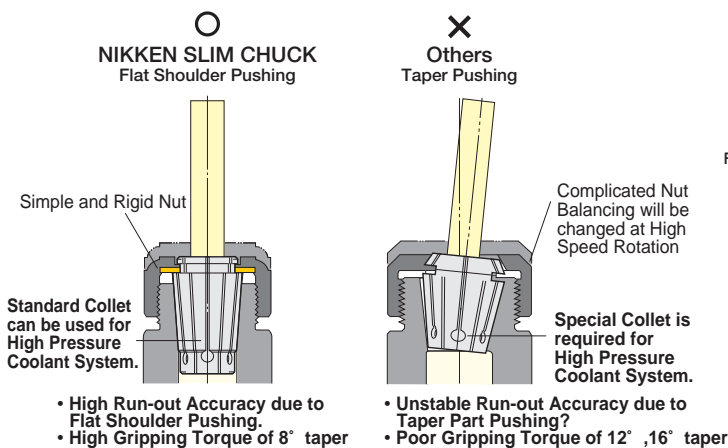
Special Coated for High Efficiency



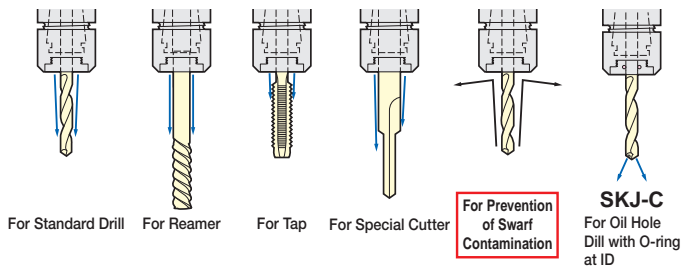
J nut is the best solution for the centre through coolant application, and strongly recommended to use for the high accuracy and the high productivity.

PAT.

Flat Shoulder Pushing & Taper Pushing



Standard Nut & J Type Nut

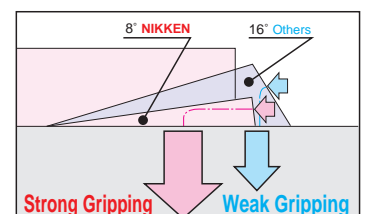
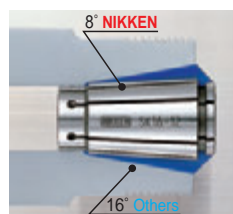
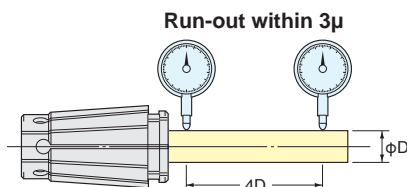


When SK J type nut is used, the total chuck length will be extended by 6mm.

The Secret of strong gripping power and high rigidity... 8°Taper

8°Taper and Wedge Principle is the Answer.
 The smaller the Taper Angle, the better Concentricity is obtained. Besides, thanks to Wedge principle, Strong Gripping Power is generated with small torque.

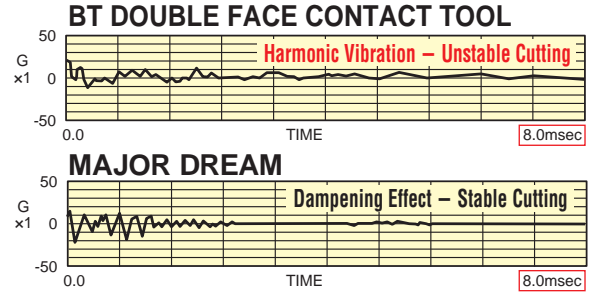
P Class Concentric Accuracy



Revolutionary Dampening Mechanism



Internal Dampening Mechanism is built-in to the MAJOR DREAM Holder.

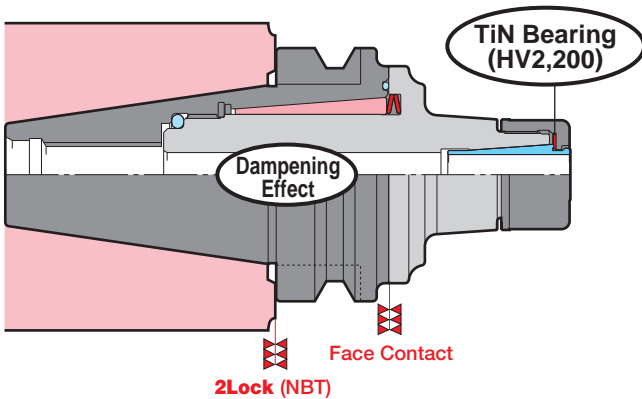


Difference due to Dampening Technique and Effect

Excellent Machining on { Linear Guide M/C
Box Guide M/C

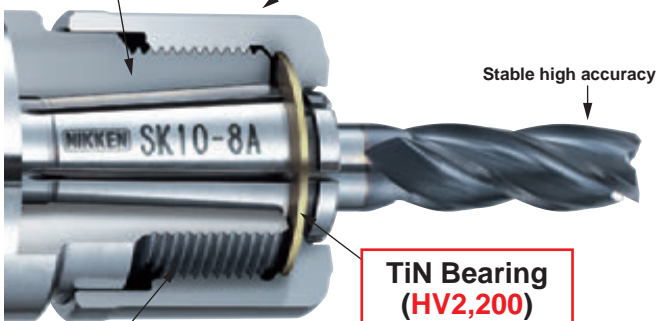


Dampening Effect & Power of TiN Bearing Nut



Slim Collet with 8 degree taper to satisfy the accuracy and the high gripping torque.

Simple design without the flats for the hook spanner. The GH handle is used to tighten / loosen precisely. The external diameter is more compact than the external diameter of the ball bearing nut.



TiN Bearing (HV2,200)

The molybdenum is coated to the internal thread of the nut, then the efficiency of the thread is highly improved.



J nut is the best solution for the centre through coolant application, and strongly recommended to use for the high accuracy and the high productivity.

Great Popularity of MAJOR DREAM 3 Brothers

- MAJOR DREAM SHRINK FIT HOLDER P.171
- MAJOR DREAM PRO ENDMILL P.172



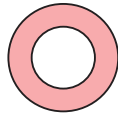
This is the Mighty End Mill Holder from the series of Tin Bearing Nut type collet chuck to satisfy the gripping torque, run-out accuracy, cutting rigidity, high precision finish and high speed rotation.

2LOCK tooling can be used as the BT double face contact tooling on the machine with the BT double face contact spindle. It can be also used as the BT tooling on the machine with BT standard spindle.

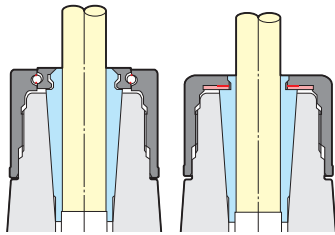
◇ **Power of TiN Bearing Nut**

Good sliding effect due to the surface hardness of HV2,200.
 More efficient than conventional ball bearing built-in nut.

Unstable accuracy caused by tightening torque and the possibility of



The Tin coated bearing plate reduced friction. This is the best for the thrust load.



Competitors

NIKKEN

◇ **Less micron vibration due to the collet flange contact**

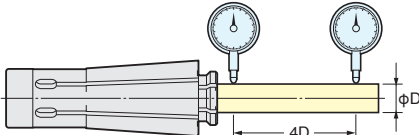
Improves the cutting capability and tool life.

◇ **Run-out accuracy :**

Less than 3 microns at 4XD

Better stability on run-out accuracy
 Improves the surface finish
 Suitable for finish on die-mould machining.

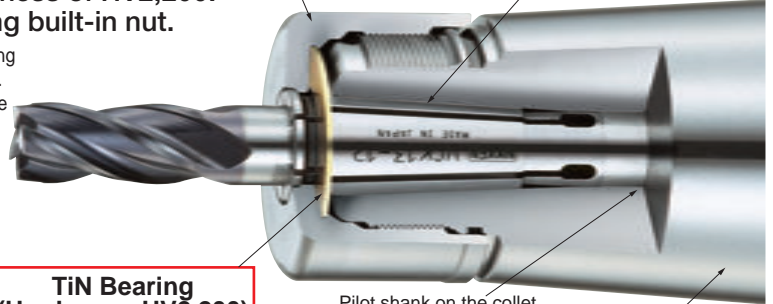
Less than 3 microns



Simple external design without the notches to be tightened with GH handle Ultra high speed rotation

8 deg. internal taper proven with the Slim Chuck for the accuracy and gripping torque.

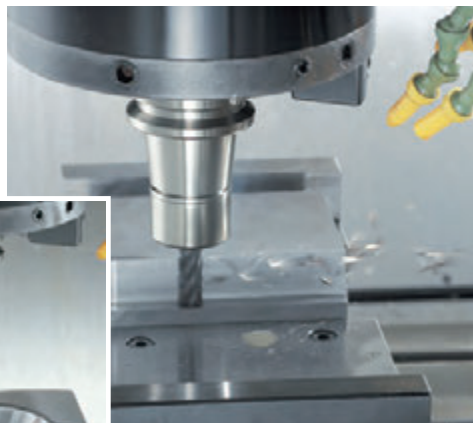
PAT.



TiN Bearing (Hardness : HV2,200)

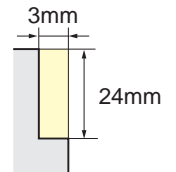
Pilot shank on the collet for further stability of the accuracy.

The thick wall design of the VC Holder body improves its cutting rigidity.



12mm, 4teeth Carbide Endmill

Material : Mild Steel
 V=220m/min
 S=6,000min⁻¹
 F=3,000mm/min



Power of TiN Bearing

Cutting Rigidity

High Precision Finish

◇ **Jet coolant splash with J type Nut.**



Cap with triangular grooves
 The jet coolant pressure creates a tornado effect.

Cap with O-ring
 For oil hole cutting tool

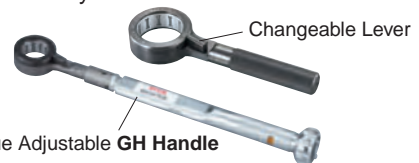


◇ **High Speed Rotation MAX.40,000min⁻¹ & G2.5**

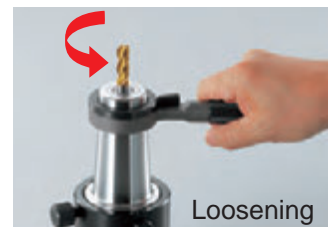
◇ **Easy, safe and reliable handling with GH Handle**

USA PAT.

The nut has no notches for high speed rotation and **GH Handle** can tighten the nut with half of the tightening torque of the conventional C type spanner, thus, substantial improvement for quality of safety, reliability and operational efficiency will be obtained.



Tightening

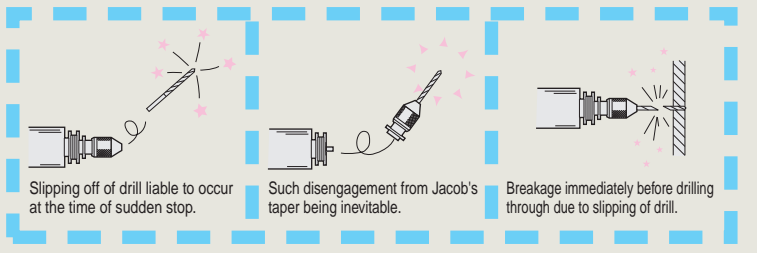


Loosening

“Solid” means Compact, Precision, Rigidity and Safety.

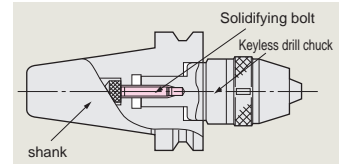


Such troubles will not only hinder an unmanned operation in FMS but cause successive occurrence of defective products to obstruct the rationalization of factory.



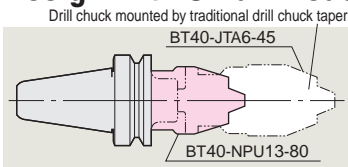
Solid design eliminates the slipping off.

The keyless drill chuck is tightened by the solidifying bolt to the shank, so that there is no possibility of slipping off during rotation or drilling.



Compact Design with Small Head

--- line illustrates the ISO or conventional drill chuck.



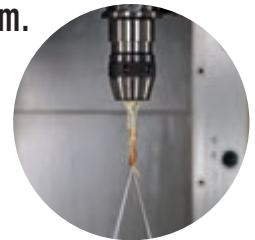
Run-out Accuracy of MAX. 0.04mm.

3 Times Larger Chucking Power

Even Carbide Drill does not occur Slipping.

Centre through tool coolant

NPU13 can be used as centre through tool coolant holder for the shank diameter bigger equal to $\phi 6\text{mm}$. (Option)

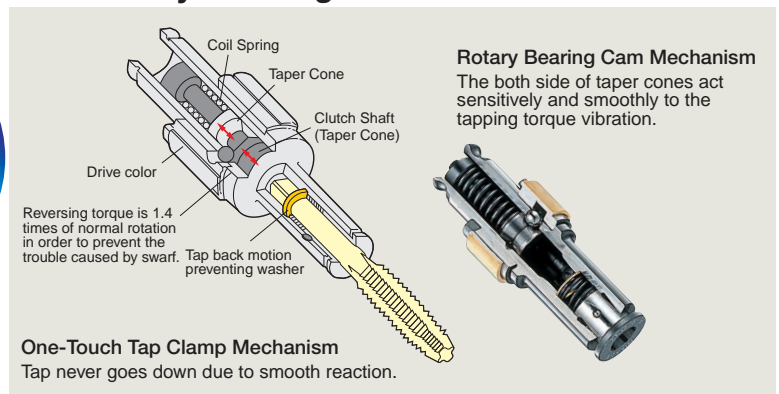


NIKKEN TAPPER CHUCK

Rotary Bearing Cam ensuring Precision, Sensitivity & Long Tap Life.



Rotary Bearing Cam



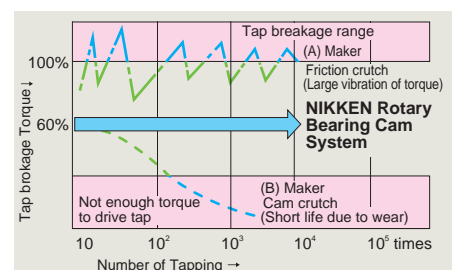
Slim Body & Fine Floating

External Diameter as small as ever. Only NIKKEN Tapper Chuck performs even big size Tapping with slim body. The floating part is not a simple slide key, but plural preloaded balls are arranged in V-shape. That is why the tap slides smoothly without chattering accompanied.



Torque Life Curve

The bearing cam with no sliding friction has been developed for the tap collet to protect the tap from breakage. The principle of this collet is fundamentally different from that of the conventional brake system utilizing a rubber reaction or a friction resistance as shown by the following graphs (A) & (B), so that constant torque characteristic as illustrated is obtainable to secure safety of tapping



φ3~50 Developed with all of NIKKEN Knowhows-Best Help of Fine Boring



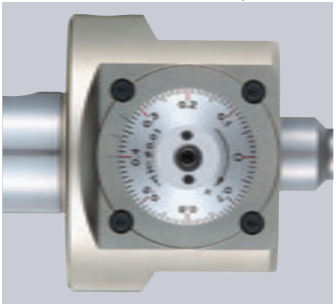
Photo shows new DJ8 series.

Easy to Set Micron Accuracy

Easy operation with big dial graduations together with a wide adjusting range for fine boring of dia.3~50mm.

Dial Graduation
 1 Graduation: dia.0.01mm
 Vernier reading: dia. 0.005mm
 Smooth and High Precision Boring is ensured.

Micron accuracy can be obtained easily



No Vibration and Least Wearing of Carbide Insert.

4 pcs of DJ Boring Bits are provided as standard accessories. Even 1mm stock removal on diameter can be done with maintaining fine surface finish without vibration.



φ3~8mm

New Byte Series for DJ8 P.84

Special Carbide Indexable Insert for φ5mm Boring

Now Special Carbide Indexable Inserts for φ5~15mm are available for DJ Bit. No more regrinding and the **shank is solid Carbide**. Fine boring of φ5mm from 4.5mm drilled hole can be done without vibration and without bending. Fine boring of Safety and Sureness by DJ Boring Head.



High Pressure Coolant Through Type



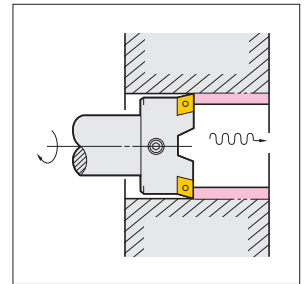
- Cutting Speed..... 100m/min.
- Feed 0.05mm/rev
- Stock Removal 0.5mm(on Dia.)
- Boring dia..... φ30mm
- Material..... SKD11

φ25~580 Scram Type Cartridge Power & Smooth Boring with 250% Productivity



Double Cutting Capability

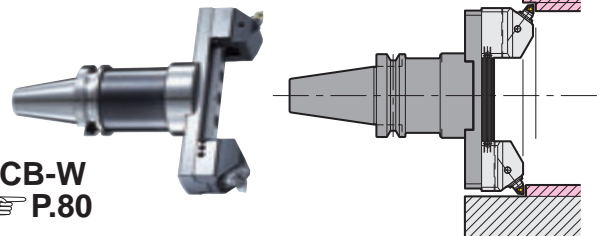
From φ25~580mm, all Balance Cut Boring Bars execute boring in 2 Carbide Inserts. One side cutting will not occur, and vibration is absorbed each other. The faster the feed rate (0.2~0.4mm/rev.), the better swarf ejection. Ideal for Rough and Medium Boring.



2 Stepped Balance Cut

Approx. double removal of standard cutting condition is possible by -0.3mm Cartridge.

Stepped Boring



BCB-W
P.80

Various Cartridges & Inserts P.72

Good Chip Ejection ensures no trouble Heavy Boring. Standard carbide insert is suitable both for Steel and Cast Iron. Besides, optional cartridges for steel, for Aluminium, through hole or multi-sheets are available.

RAC-E

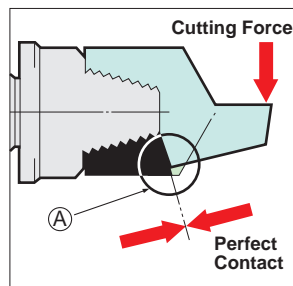
RAC-A

RAC-K



Power of Scram Type Cartridge

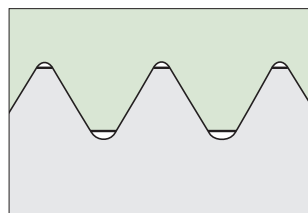
Cutting force is supported by the shoulders of both cartridges. This is the secret of heavy and powerful boring even at the intermittent bore.



Precision Ground Serration

High Precision Serration is the base of high accurate performance of BALANCE CUT Boring Bar.

- Even strong cutting force is accepted by High Precision Serration, resulting in smooth boring without micro vibration.
- All slides are finished by precision grinding. Even micro adjustment can be done smoothly as you desire.

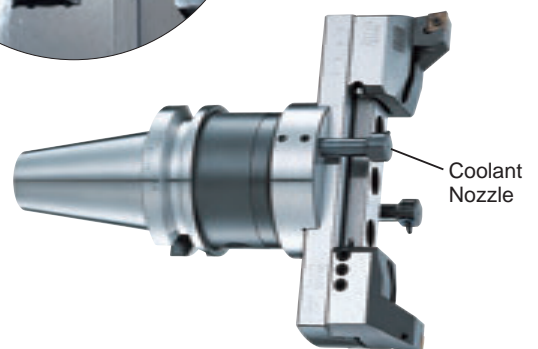


Precision Ground = Basic Serration

High Pressure Coolant Through Tool



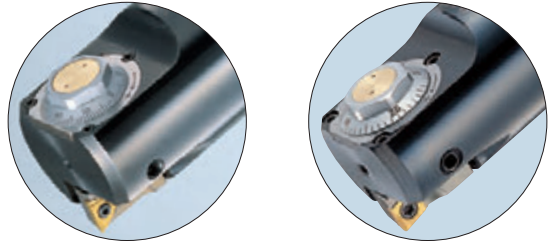
- Cutting Speed 150m/min
- Feed Rate 0.4~0.6mm/rev
- Stock Removal 6~10mm(on dia.)
- Boring Dia φ60mm
- Material SNCM420 (Ni, Cr, Mo Alloy Steel)



φ16~180 The World Leading Boring Head

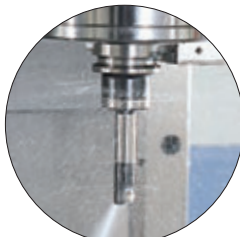


Various types of Insert Tips

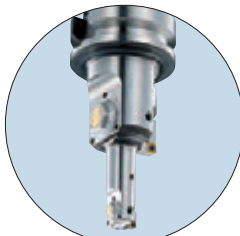
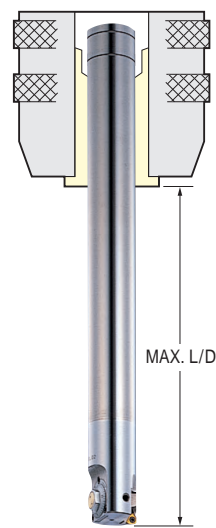


Steel, cast iron and stainless steel can be machined by the same coated insert tip.

Application



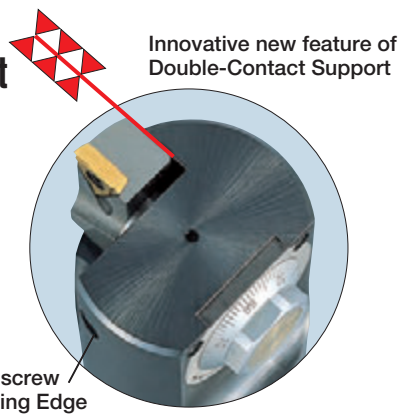
Coolant Through Tool Capability



Available for Multi-Stage Boring Bar

Axially Adjustable ZMACX for Deep Hole Boring

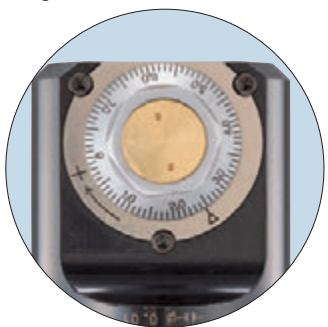
High rigidity Double-contact support



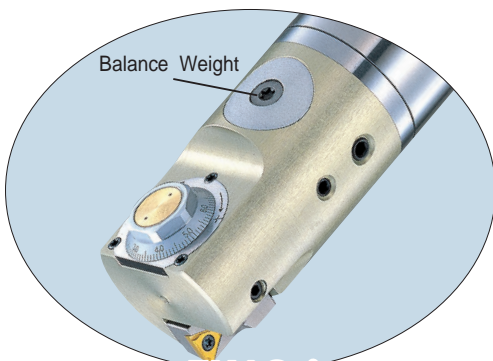
New Locking screw closer to Cutting Edge

High-precision / Easy micro-adjustment / High durability

Thread on Cartridge:
Hardness of HRC50-55 & precision ground
Internal thread of dial ring:
Special heat-treated to HV800



High Speed Boring 12,000nin⁻¹, Deep Hole Boring



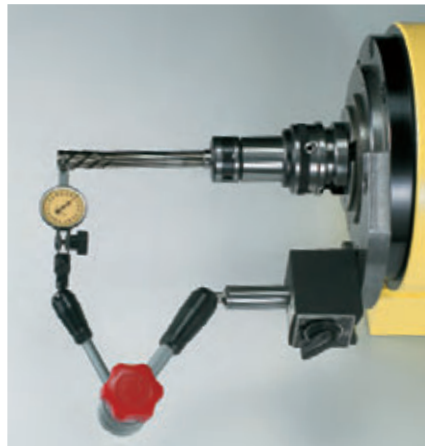
ZMACX

Special Hardened Light Alloy Metal Head with Balancing for Anti-Vibration.

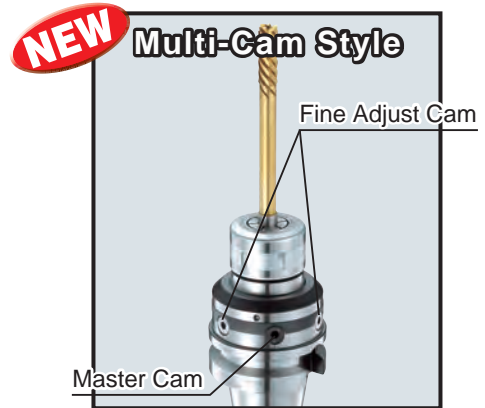
When the machine has been used for 2~3 years, the run-out accuracy of the spindle will be declining with accuracy of 0.01mm~0.04mm at 100mm from the gauge line, the Zero Fit Holder allows correction of this error back to the run-out of 0.001~0.002mm.



At Machine Spindle



At Tool Presetter



Multi-Cam Style

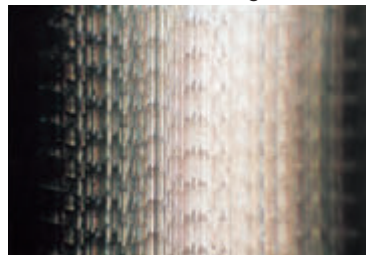
The minute run-out after adjusting by a master cam can be adjusted by fine adjust cams at the same position.
 e.g. BT40-SZF16-90-C3 (3 Cams)
 The multi-cam style can not be made for all zero fit holders.

With “0” Fitting the Tool Run-out Accuracy;

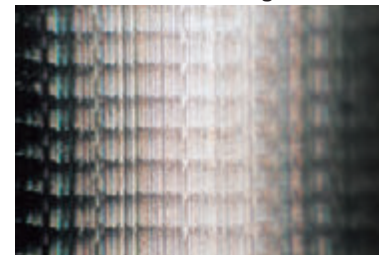
■ The milling surface finish and quality can be improved.

Materials : Pre-Hardened Steel NAK55 (HRC39)
 End Mill : 10mm, 2 teeth Carbide Ball End Mill
 Cutting Speed : V=200m/min
 Spindle Rotation : S=6,366min⁻¹
 Feed per tooth : f=0.15mm/min
 Feed : F=1,910mm/min
 Dry Cutting with Air blow

Before Zero Fitting :
 Run-out at cutter front edge = 20 microns



After Zero Fitting :
 Run-out at cutter front edge = 1 micron

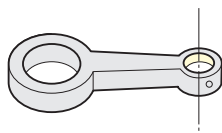


■ For better and stable finish tolerance for machining holes

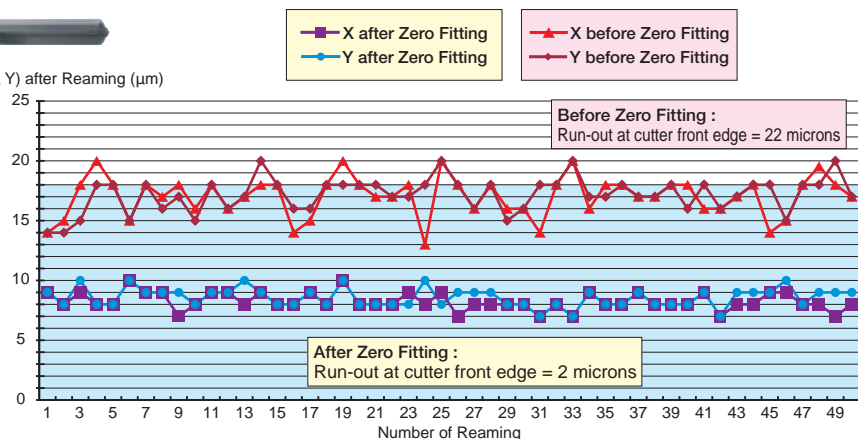
...The variation at finish tolerance can be minimized, thus the finish size tolerance can be reduced.



Materials : Tempered Steel (HRC25~30)
 Tool : φ13mm CBN Reamer
 Cutting Speed : V=80m/min
 Spindle Rotation : S=2,000min⁻¹
 Feed per tooth : f=0.1mm/min
 Feed : F=200mm/min
 External coolant supply : Water soluble



Bore Dia.(X, Y) after Reaming (μm)



TOOL LIFE (Relative Comparison)

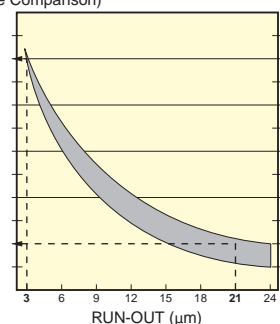


Fig.1

■ The tool life can be extended.

Fig.1 shows the relation between run-out accuracy and tool life, and when the run-out accuracy of 21 microns is reduced to 3 microns, the tool life can be improved by approximately 5 times.

■ Zero Fit Holder has wide adjustment range compared with competitors equivalent, and its mechanism performs simple, quick and secured operation.

■ The choice of the Slim Chuck style “SZF” & the Anniversary type Milling Chuck style “CZF” can be selected depending on your cutter.

NIKKEN DOUBLE FACE CONTACT TOOLING SYSTEM

Min. Z Displacement
ATC Repeatability

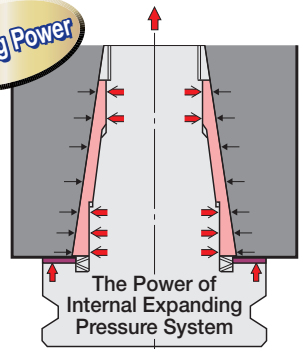
7/24 Taper For BT Double Face Contact Spindle **P.140**

3LOCK Tooling System PAT. P.139

When the tool is clamped, the gentle taper of main body internally expands to create a dead lock of the taper connection, then it results in maximizing the pulling force. The ideal clamping ratio of taper : flange = 90% : 10% is achieved.

Tool Life 3~5 times

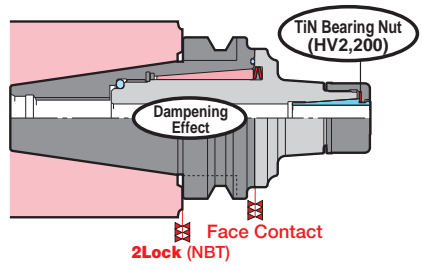
Cutting Power



2LOCK Tooling System P.158

2LOCK Tooling System is not the simple double face contact system of taper and flange, but the system with dampening effect and the excellent front chucking system.

2LOCK MAJOR DREAM Holder



1/10 short Taper & Polygonal Taper

Tool Life 3~5 times

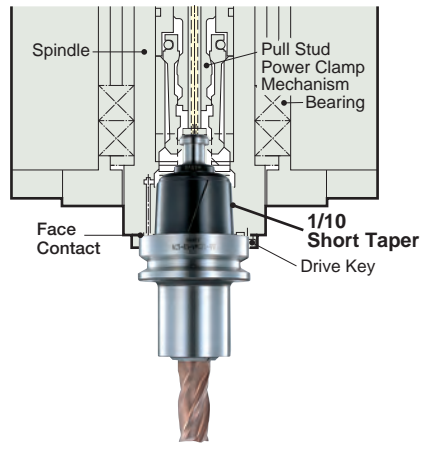
Cutting Power

Rigidity

Dampening Effect

NC5 Tooling System P.193

Since the launch of the Nikken **NC5 Tooling System** at JIMTOF'94 OSAKA, the system has proven its outstanding capability is a wide cross-sector of Japanese industry, with ever-increasing expectation of its being adapted as the next generation tooling interface. Unique tool construction is built-in NC5 tooling system. The slotted taper cone which is pre-loaded by a disc spring increases its vibration dampening effect, then finally adjusting the minute gauge line error completely. Chattering Stability = Static Stiffness X Dampening Ratio. Thus, the advantage of NC5 tooling system is clearly demonstrated.



HSK Tooling System P.208

HSK-A shank is the hollow shank with 1/10 taper, and taper & flange contact system. This is based on **ISO 12641-1 (DIN69893-1)**. It's not well balanced due to the unsymmetrical shape, but Nikken HSK-A shank has a hole and a flat for mass balancing as standard.

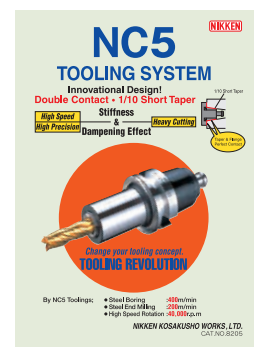
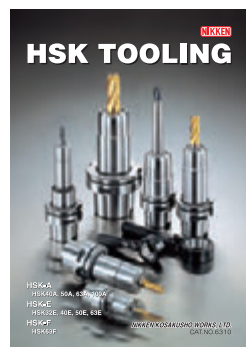
HSK-E & HSK-F shank are the shank without drive key slot and U groove. This is based on DIN69893-5, 6. This is used for high speed application.

HSK40A, 50A, 63A, 100A
HSK25E, 32E, 40E, 50E, 63E
HSK63F } are available.

Polygonal Taper C6 Tooling

C6 tooling system is used for the tooling of the integrated machine.

Please refer **C6 Tooling catalogue**



NIKKEN FACTORY AUTOMATION SERIES

Spindle Speeder  P.112



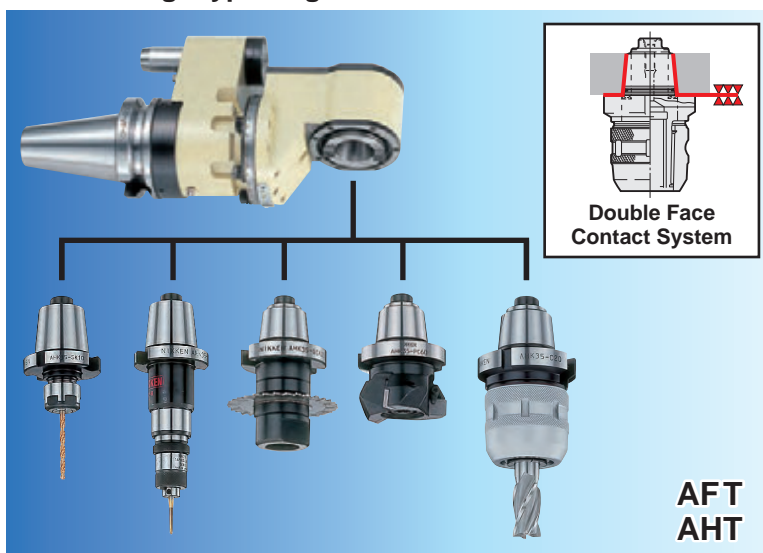
Air Motor Spindle Tool  P.113



Air Turbine Spindle Tool  P.112



Quick Change type Angular Head  P.115



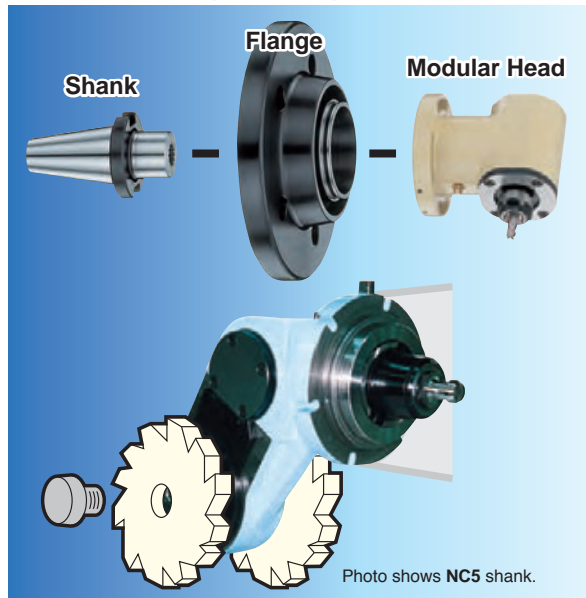
Modular type Angular Head  P.116



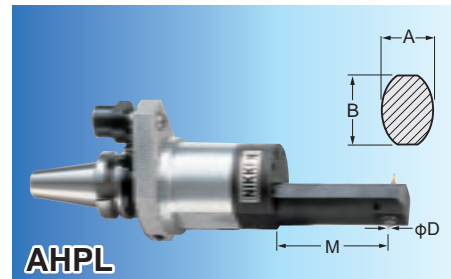
Solid type Angular Head  P.118



Direct Mount Flange type Angular Head  P.119



Compact type Angular Head for Deep Hole  P.117



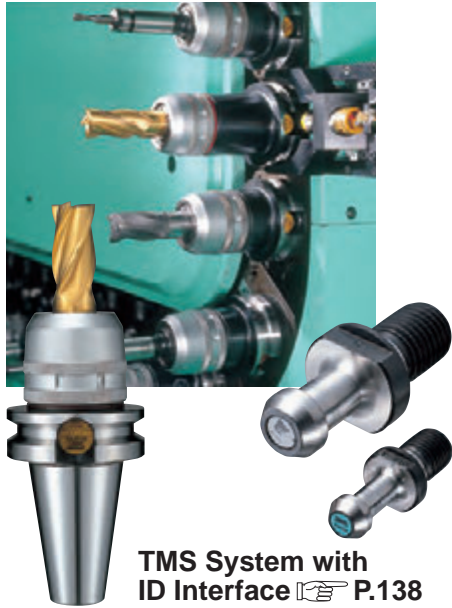
NEW

New Series Addition

Taper	Style	φD	MAX. M	A	B
BT40	AHPL 4	1~4	104	25	31
	AHPL 6	1~6	102.5	36	45
BT50	AHPL 6	1~6	102.5	36	45
	AHPL 8	1~8	125	43	47.5
	AHPL16	Direct*	70	37	45

★Direct * : Large diameter of φ16mm with 8 degree taper

NIKKEN FACTORY AUTOMATION SERIES



RPT Treatment P.106
 The RPT treatment creates a fine film of the contents (Fe₂O₄) and (Fe₂O₃), and penetrates into the tool holder 1 ~2 micron deep. This fine film inhibits the rust and corrosion of your tool holder taper and stops it from being transmitted to your machine spindle. The RPT treatment will not effect the accuracy and the hardness of your tool holder.

Multi Spindle Drill Head P.119

Multi Spindle Tapper Head P.119

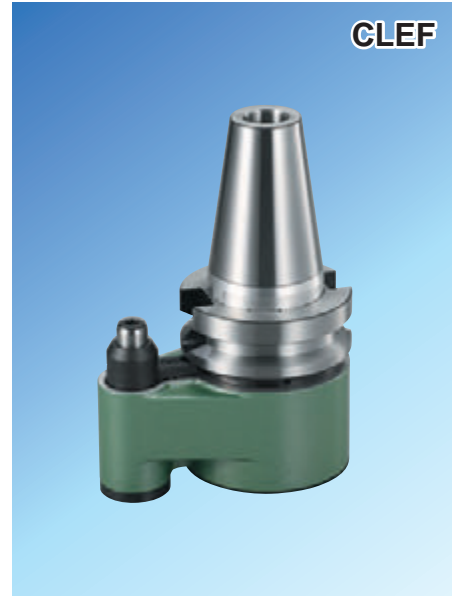
Automatic/Manual Back Spot Facing Arbor P.121



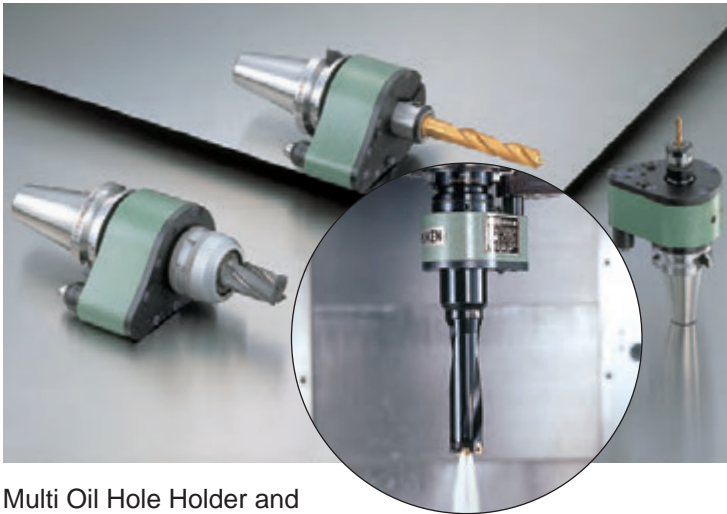
Oil Piaster P.153

Spindle Taper Cleaner P.153

Spindle Flange Cleaner P.153



Conventional Oil Hole Holder + Multi Coolant Nozzles



Multi Oil Hole Holder and **COMBAT Z DRILL** are recommended for drilling on M/C to increase productivity.

Combination of Coolant Through Tool Type and Outside Nozzle Type

Can be used to both oil hole cutter and normal cutter without oil hole. When normal cutter (drill, end mill, tap etc.) is used, coolant is fed as Jet Streams exactly to cutting point.



Oil Hole Drill



Multi-Nozzles

- Standard MT Drill & Reamer
- Standard Straight Drill & Reamer
- Tap
- End Mill
- Boring Bar



NIKKEN COMBAT Z DRILL

φ16~80mm Power of Pilot Drill & 3 Phases Heat Treatment



Power of Pilot Drill

No Vibration with Pilot Drill

L/D=3 and 4 times as standard



3 Phases Heat Treatment & Suitable Twisted Shape improves Ejecting Cutting Swarf.

3 Phases Heat Treatment

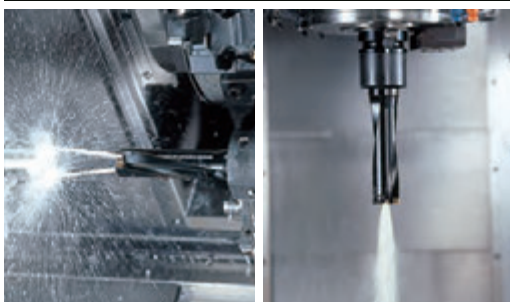
- It significantly improves Rigidity and Ejecting Cutting Swarf by suitable twisted shape and special surface treatment. Tool life of Insert and Drill grows 3 times longer.
- Pilot Drill prevents Inserts from chipping by reducing vibration.
- Powerful drilling speed of 120~150m/min. with small torque.
- Less cutting resistance with Rhomboid Inserts.

PN Treatment (Ejecting Cutting Swarf)



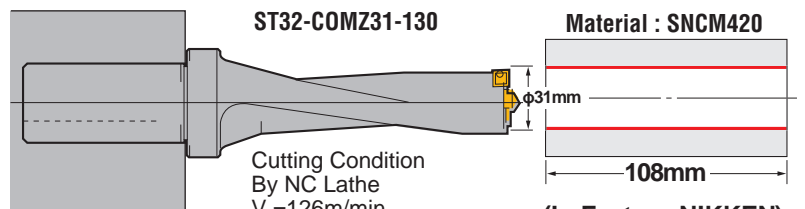
IN Treatment (HV900)

3 Phases Heat Treatment



NC Lathe

M/C

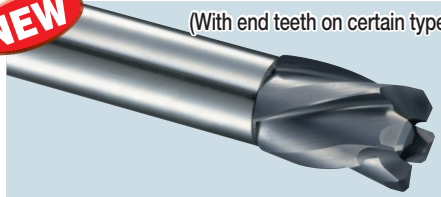


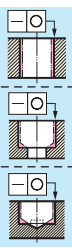
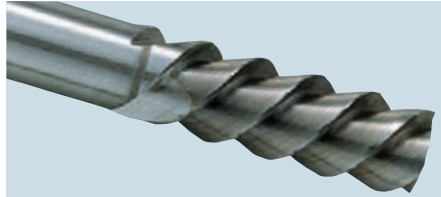



Cutting Condition
By NC Lathe
V = 126m/min
S = 1,300min⁻¹
f = 0.15mm/rev.
F = 195mm/min
Water Soluble Coolant

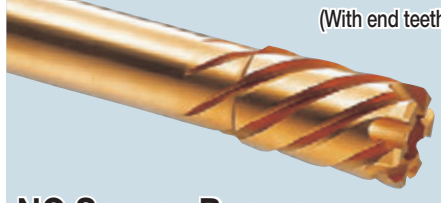
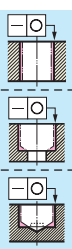

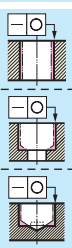


(In Factory NIKKEN)
Machining Time = 35sec.

It can be used after total cutting length = 65mm.

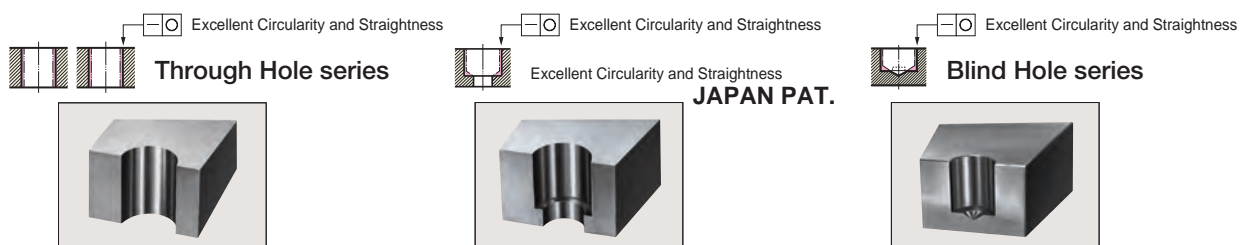
Carbide Reamer Series

<p>NEW</p>  <p>(With end teeth on certain type)</p> <p>PF Radical Reamer Series</p>	<p>The run-out accuracy and the tool life have been substantially improved with Press Fit type Radical Reamer. This is sophisticated reamer with fine powder carbide and TiCN-2 coated for low friction purpose and hardness HV3,500, thus its tool life is extremely extended even with water soluble coolant.</p>	<p>RMSS PF-RMSS Straight Shank••P.246</p> <hr/> <p>RDSS PF-RDSS Straight Shank••P.246</p>	
 <p>(With end teeth)</p> <p>Carbide Mill Reamer</p>	<p>As the Mill Reamer made by K10 grade carbide, the cutting speed can be substantially increased for the productivity improvement. Especially it performs very well on Cast Iron, Meehanite, Aluminium, and Non-steel metal.</p>	<p>HMS Straight Shank••P.247 HMM MT ShankP.247</p> <hr/> <p>FMS Straight Shank••P.248 FMM MT ShankP.248</p> <hr/> <p>RXS-F Straight Shank••P.254</p>	
 <p>Carbide Broach Reamer</p>	<p>The Carbide Broach Reamer maintain the excellent surface finish for Aluminium and Cast Iron reaming operation. The cutting speed can be substantially increased.</p>	<p>SX Straight Shank••P.249 MX MT ShankP.249</p>	

HSS Reamer Series

 <p>(With end teeth)</p> <p>NC Sensor Reamer</p>	<p>The NC Sensor Reamer is dedicated for better surface finish, especially effective on Stainless Steel, Die Steel, Annealed and Tempered Steel. The high precision finish surface can be achieved with its TiN Coated and its burnishing effect. The reamer can be used with even water soluble coolant.</p>	<p>NCS Straight Shank ••P.253 NCM MT ShankP.253</p> <hr/> <p>NCS-F Straight Shank ••P.253</p> <hr/> <p>RNS-F Straight Shank••P.254</p>	
 <p>(With end teeth)</p> <p>Tough-Cut Skill Reamer</p>	<p>This is all-mighty reamer, which is made by powder HSS & ion-nitrided and good for tough materials, die steel, annealed and tempered steel.</p>	<p>SRS Straight Shank••P.251 SRM MT ShankP.251</p> <hr/> <p>SRS-F Straight Shank••P.252 SRM-F MT ShankP.252</p> <hr/> <p>RSS-F Straight Shank••P.254</p>	
 <p>Broach Reamer</p>	<p>The reamer offers both heavy cutting capability of Broach and High Precision Finish of Reamer. The ultra high left-handed helix of 60 degree performs smooth reaming operation.</p>	<p>BRS Straight Shank••P.250 BRM MT ShankP.250</p>	

Various Application - Through Hole, Stepped Hole and Blind Hole



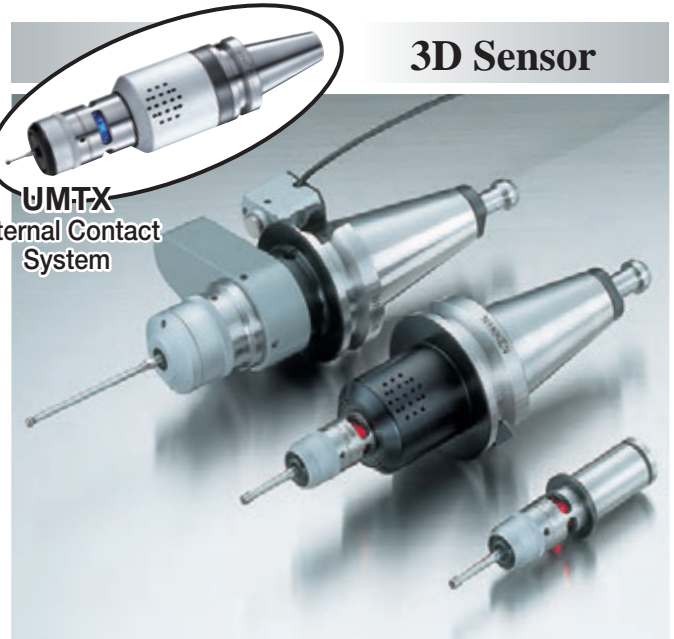
Pioneer for Work Preparation



Height Presetter

No need of test cut! Basic position of workpiece can be measured quickly without damaging tool teeth.

The distance from reference surface to tool end can be measured very quickly and accurately. This is a MUST for M/C, NC Lathe and NC Milling Machine.



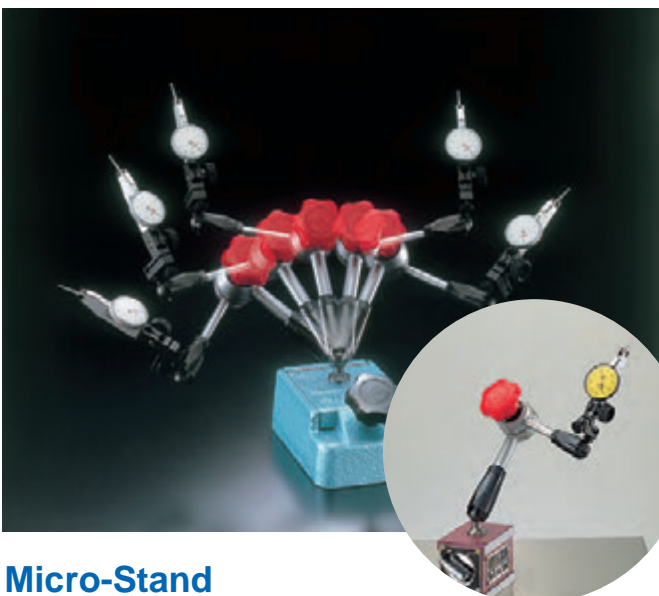
3D Sensor

Micro-Touch

This is 3D sensor enabling instantaneous detection of position, measurement and alignment of center by means of Red Lamp and Electric Beep.

The Red Lamp lights the moment when the stylus touches a measurement part. Owing to the conductive detection system, a time delay caused by a relay etc. is eliminated and a highly sensitive measurement can be made.

Small Measuring Tool, but Great Time-Saver



Micro-Stand

Free flexing with single knob, no dead angle and long reach.

Two arms incorporating ball joint mechanism at both ends provide free movement in any direction such as vertical, lateral, longitudinal or rotational etc. If stretched horizontally, a reach as long as 300mm can be attached. Measurements of inside dia., outside dia., end face and back face etc. can be made at will.

Easy Micron Check




Touch Point

Highly sensitive electronic edge finder.

Ideal for Milling Machine, Boring Machine, Drilling Machine as well as Machining Center. Instant indication by LED lamp at very light contact of sensor ball with workpiece.

Easy location of work face, O.D., I.D.

NIKKEN's Tool Presetter increasing Cost Performance of High Price Machining Centre.

E236N  P.133
(BT, HSK, CAPTO TOOLING)

NEW



E238, E450N  P.135, P.136



NTP300,400  P.137



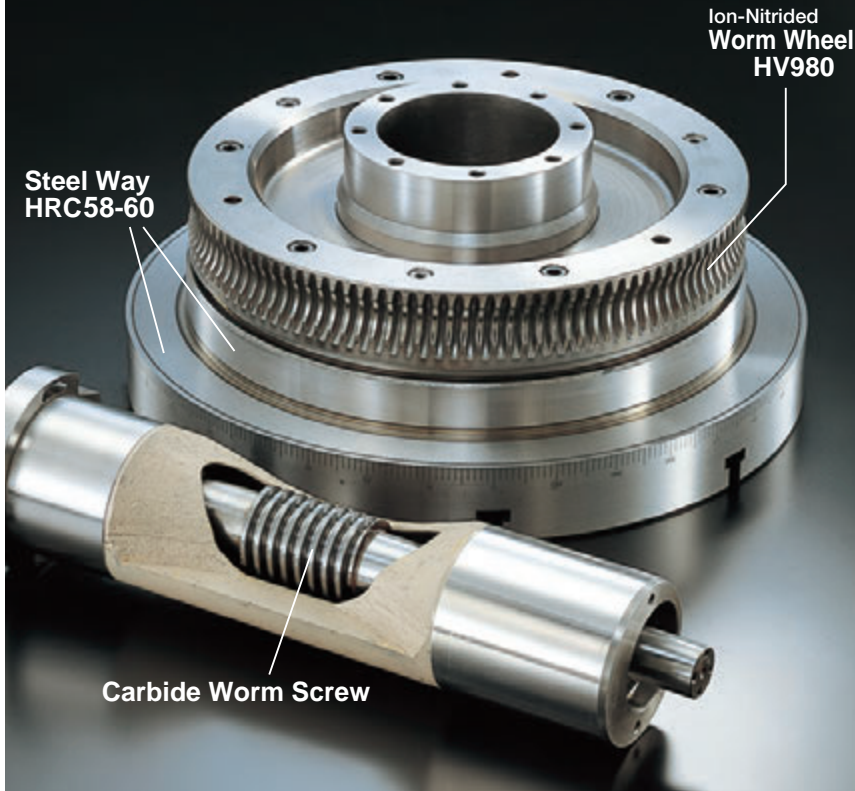
Photo shows NTP400.

NTP500  P.137



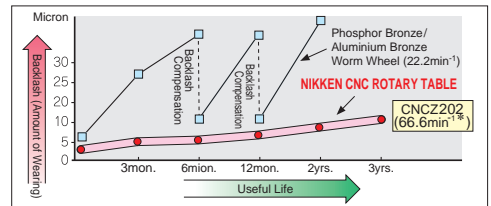
CNC ROTARY TABLE for Full Automation

Worldwide Field-proven NIKKEN CNC ROTARY TABLE
Consequently and finally, NIKKEN Carbide Worm Screw System



Carbide Worm System

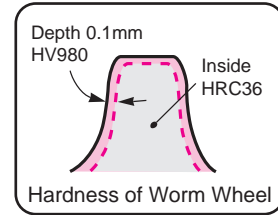
For heavy duty capability and high speed rotation with maintaining the high accuracy, the carbide worm screw is used for the hardened worm wheel. The wearing of the worm wheel is reduced and rotary table is used for more years comparing with the conventional worm system of soft material. For better impact capability, the special alloy steel worm screw is used for the worm screw of the small tooth module.



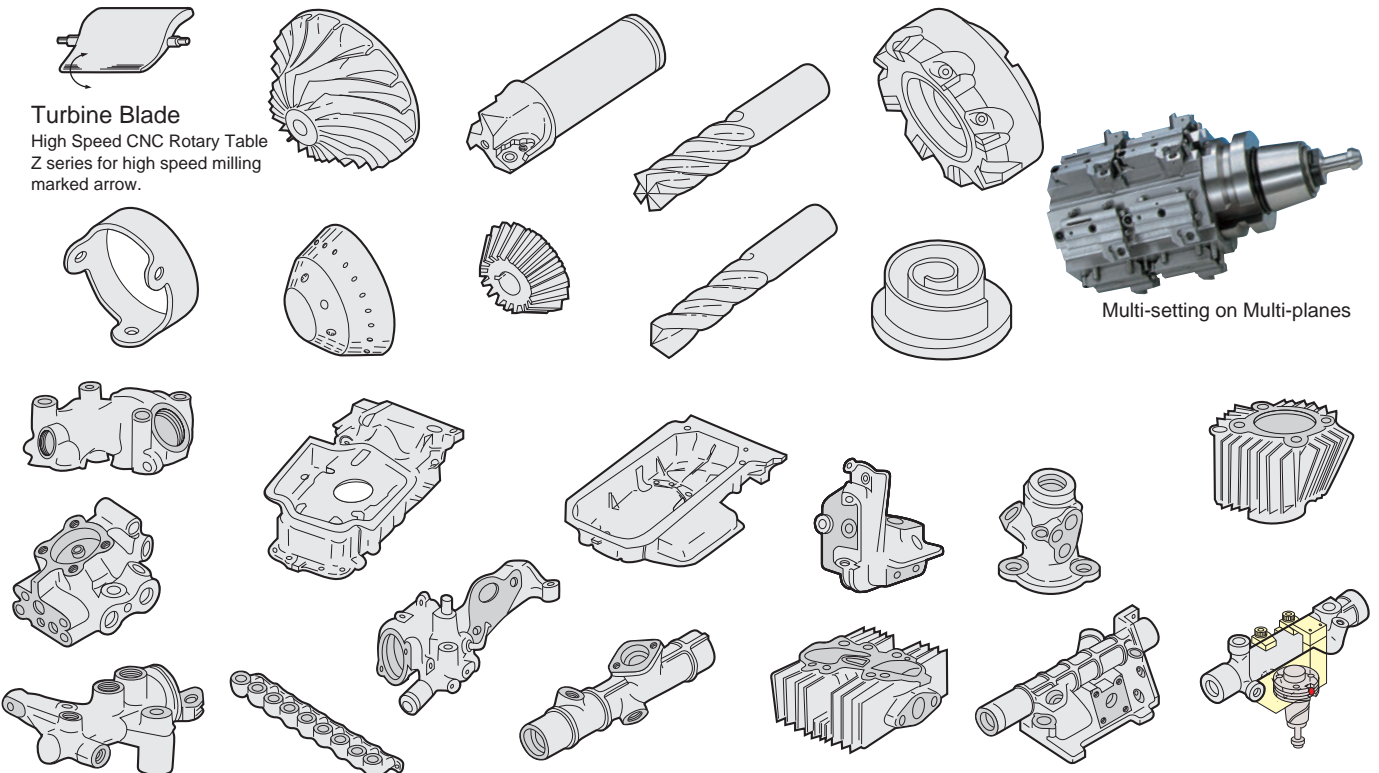
* Rotation speed of motor = 3,000min⁻¹

Worm Wheel

Material is special NIKKEN order made steel. Specially hardened and furthermore ion-nitro treated on teeth. Thus, the problem of sliding friction is solved.



Work Sample



Turbine Blade
High Speed CNC Rotary Table Z series for high speed milling marked arrow.

Multi-setting on Multi-planes

➔ Please refer to **CNC ROTARY TABLE** Catalogue.

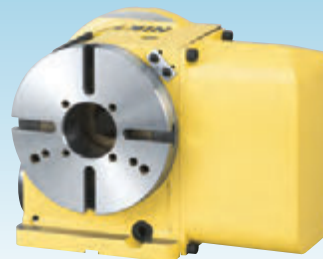
●CNC 105

P.257



●CNC 180

P.257



●CNC 202

P.257



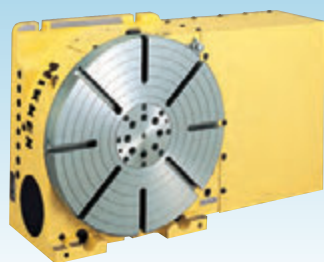
●CNC 260, 302

P.257



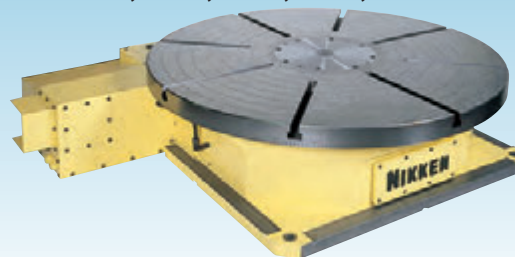
●CNC 321,401,501,601,802

P.258

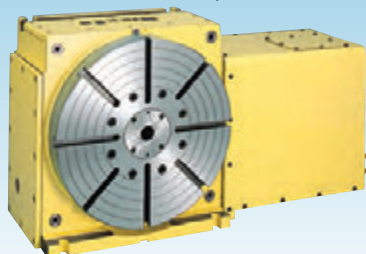


●CNC 1000, 1200, 1201, 1600, 2000

P.258



●NSVX400, 500 ●NSVZ180, 300



●NST 250, 300, 500



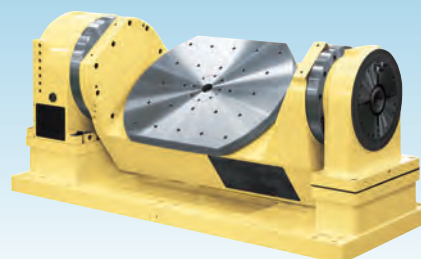
●5AX-130, -201

P.259

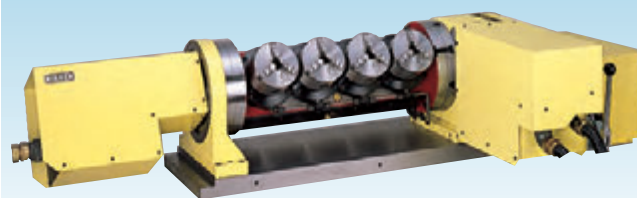


●5AX-250, -350, -550, -800, -1200

P.259

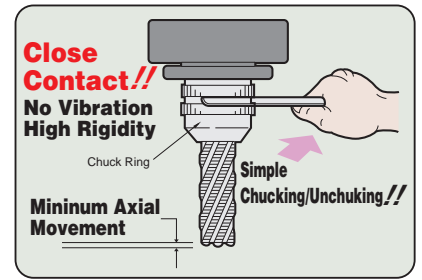
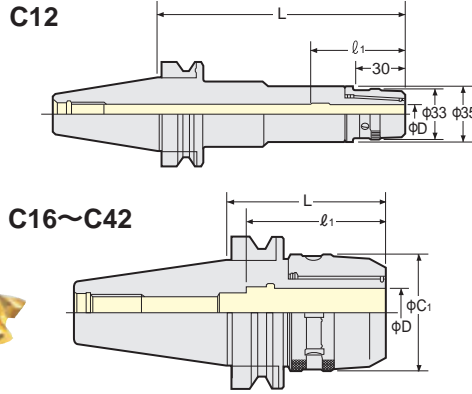
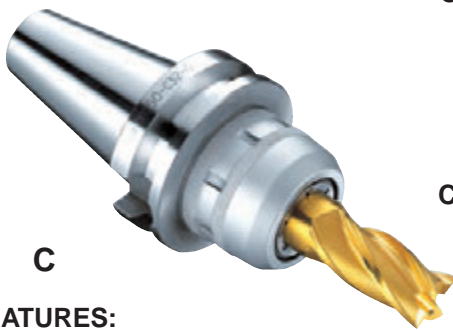


●CNC100-2W, -3W, -4W, -120

●5AX-2MT-105, -170, -200
5AX-4MT-120

MILLING CHUCK

NIKKEN



FEATURES:

- Doubled rigidity & increased cutting ability!
- Run-out Accuracy: 5µm at 3XD

PAT.

TAPER	Code No.	C ₁	L	l ₁	Suitable Collet	Weight(kg)
No.30	BT30-C12- 55	33	58	58	CCK12 KM12	0.6
	-C16- 55	44	57	65	CCK16 KM16	0.7
	-C20- 65*1, 75	52	67, 75	80	CCK20 CCNK20 KM20 NK20	1.0, 1.1
	-C25- 75*2, 80	55	75, 82	68	CCK25 CCNK25 KM25 NK25	1.2, 1.3
	-C32- 90*3, 100	64	90, 100	68, 76	CCK32 CCNK32 KM32 NK32	1.4, 1.5
No.35	BT35-C12- 60	33	60	58	CCK12 KM12	1.0
	-C16- 60	44		65	CCK16 KM16	1.1
	-C20- 70	52	70	80	CCK20 CCNK20 KM20 NK20	1.3
	-C25- 75	60	75	68	CCK25 CCNK25 KM25 NK25	1.5
	-C32- 85	64	85	77	CCK32 CCNK32 KM32 NK32	1.8
No.40	BT40-C12- 65, 90,120	33	65, 90,120	58	CCK12 KM12	1.3, 1.6, 1.9
	-C16- 60, 90,120	44	63, 90,120	65	CCK16 KM16	1.4, 1.7, 2.0
	-C20- 70, 90,105,120	52	71, 90,105,120	80	CCK20 CCNK20 KM20 NK20	1.6, 1.8, 2.0, 2.2
	-C25- 70, 90,120	60	70, 90,120		CCK25 CCNK25 KM25 NK25	1.8, 2.1, 2.5
	-C32- 85,105,120	69	85,105,120	77,90,105	CCK32 CCNK32 KM32 NK32	2.1, 2.5, 2.8
No.45	BT45-C12-105	33	105	58	CCK12 KM12	3.0
	-C16-105	44		65	CCK16 KM16	3.2
	-C20-105	52		80	CCK20 CCNK20 KM20 NK20	3.5
	-C25-105	60	85	105	CCK25 CCNK25 KM25 NK25	3.8
	-C32- 85	69	85	105	CCK32 CCNK32 KM32 NK32	3.3
	-C42-110	86	110	125	CCK42 CCNK42 KM42 NK42	4.5
No.50	BT50-C12-105,135,165	33	105,135,165	58	CCK12 KM12	4.0, 4.3, 4.6
	-C16-105,135,165	44		65	CCK16 KM16	4.2, 4.5, 4.8
	-C20-105,135,165,180	52	105,135,165,180	80	CCK20 CCNK20 KM20 NK20	4.5, 4.8, 5.1, 5.4
	-C25-105,135,165	60	105,135,165		CCK25 CCNK25 KM25 NK25	4.8, 5.2, 5.6
	-C32- 90,105,120,135,165 -200,250,300	69	90,105,120,135,165 200,250,300	105	CCK32 CCNK32 KM32 NK32	4.3, 4.6, 5.1, 5.6, 6.4 7.8, 9.2, 10.6
	-C42- 95,105,120,135,165 -200,250,300	86	95,105,120,135,165 200,250,300	125	CCK42 CCNK42 KM42 NK42	5.5, 5.8, 6.6, 7.2, 8.6 9.5, 11.7, 14.0

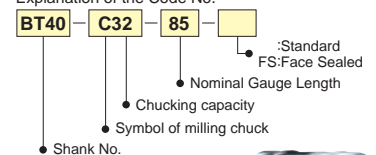
★MULTI LOCK Milling Chuck is a Base Holder for machining centre.

The following straight shank tooling to suit Milling Chucks are available.

- [S-C] Milling Chuck (Extension Type) P.31
- [K-MMP] MINI-MINI Chuck P.33
- [K-MMC] MINI-MINI Chuck P.33
- [K-SK] Slim Chuck P.40
- [S-SK] Long Size Slim Chuck P.40
- [D-NPU] NC Drill Chuck P.45
- [NZ] Tapper Chuck P.56

- [K-MT] Morse Taper Socket P.47
- [K-ZMAC] ZMAC Boring Bar P.89
- [K-RAC] RAC Boring Bar P.89
- [S-ZMACX] ZMAC Boring Bar for Deep Hole P.90
- [K-DJ] DJ Boring Bar P.91
- [K-SCA] Stub Arbor P.104
- [S-MDPE] PRO-END MILL P.103
- [MSO-AO-O] Straight shank shrink fit holder P.172

Explanation of the Code No.



★Please refer P.159 for heavy duty type milling chuck with larger arbor diameter.

★Please refer P.31, P32 for KM, NK, CCK, CCNK collet.

★CKFN-D and CKFN-DC (With O-ring) can be used for the direct chucking application, when centre through tool coolant. CCK collet and CKFN nut can be used for collet application.

★For "L" dimension of centre through coolant type milling chuck is same as the above standard, however, refer P.105 for Code No.

★For "L" dimension of flange through coolant type milling chuck is same as the above standard, however, refer P.107 for Code No.

★Spanner is available as an option. C12 (φ30) : 9HC12, C12A (φ33) : 9HC12A, C16: 9HC16, C20: 9HC22, C25 (φC1=55mm) : 9HC22, C25 (φC1=60mm), C32 (φC1=64mm) : 9HC25, C32 (φC1=69mm) : 9HC32, C42: 9HC42

★Please note the acceptable shank tolerance is h7.

★The milling chucks marked *1, *2 and *3 may not be used by the restriction of the diameter under V flange of your M/C.

★FS (Face Seal) types are available for C25~C42 of BT40/BT50. There are 2 types; FSJ: With J groove, FS: Without J groove



FS type
For machining of aluminum

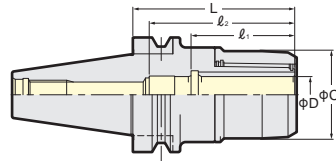


HIGH SPEED MILLING CHUCK

NIKKEN



C-G
High Pressure Centre Through
(MAX. 7MPa)



GFS type
For machining
of aluminum

High Speed

PAT.

TAPER	Code No.	D	C ₁	L	ℓ ₁	ℓ ₂	MAX. min ⁻¹	Suitable Collet	Weight(kg)
No.30	BT30-C12- 55G	12	33	58	48	58	40,000	CCK12 KM12	0.5
	-C16- 55G	16	40	57	50	65		CCK16 KM16	0.6
	-C20- 65G* ¹ , 75G	20	48	67, 75	57	80	30,000	CCK20 CCNK20 KM20 NK20	0.9, 1.0
	-C25- 75G* ² , 80G	25	55	75, 82	56	68		CCK25 CCNK25 KM25 NK25	1.2, 1.3
	-C32- 90G* ³ , 100G	32	62	90, 100	67	68, 76		CCK32 CCNK32 KM32 NK32	1.4, 1.5
No.40	BT40-C12- 65G, 90G	12	33	65, 90	48	58	30,000	CCK12 KM12	1.1, 1.3
	-C16- 60G, 90G	16	40	63, 90	50	65		CCK16 KM16	1.2, 1.5
	-C20- 70G, 90G	20	48	71, 90	57	80	25,000	CCK20 CCNK20 KM20 NK20	1.4, 1.7
	-C25- 70G, 90G	25	55	70, 90	60			CCK25 CCNK25 KM25 NK25	1.6, 2.0
	-C32- 85G, 105G	32	68	85, 105	67, 70	77, 90	20,000	CCK32 CCNK32 KM32 NK32	1.9, 2.3
No.50	BT50-C12-105G, 135G	12	33	105, 135	48	58	20,000	CCK12 KM12	3.9, 4.2
	-C16-105G, 135G	16	40		50	65		CCK16 KM16	4.1, 4.4
	-C20-105G, 135G	20	48		57	80	15,000	CCK20 CCNK20 KM20 NK20	4.4, 4.8
	-C25-105G, 135G	25	55	60	CCK25 CCNK25 KM25 NK25			4.6, 5.2	
	-C32- 90G, 105G, 120G	32	68	90, 105, 120	70	105	CCK32 CCNK32 KM32 NK32	4.3, 4.7, 5.2	
	-C42- 95P, 120P	42	86	95, 120	73	125	12,000	CCK42 CCNK42 KM42 NK42	5.5, 6.6

★All high speed type milling chuck are centre through coolant type. Please use a stopper or CCK, CCNK collet, when endmill shank length is shorter than "ℓ₁" dimension.

The Code No. of stopper for direct chucking
C20: 9MC20H, C25: 9MC25H (BT30-C25-75G: 9MC20HB), C32: 9MC32HD (BT40-C32-85G: 9MC32HDA, BT40-C32-105G: 9MC32HDB), C42: 9MC42H

★The milling chucks marked *1, *2 and *3 may not be used by the restriction of the diameter under V flange of your M/C.

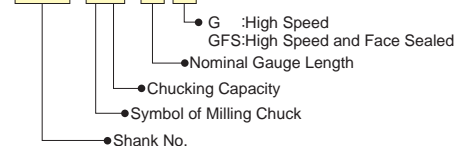
★*4: The Code No. of the wrench for C42 is 9HC42.

★GFS(Face Seal)types are available for C25~C42 of BT40/BT50. There are 2 types;

GFSJ: With J groove, GFS: Without J groove

Explanation of the Code No.

BT40 - C16 - 60 G



GH Handle for HIGH SPEED TOOLING

NIKKEN



Torque adjustable GH Handle

GH

GH Handle has a two-way tightening/loosening ratchet on the handle that has been developed to provide quick and convenient loading of the tool. The GH Handle also dispenses with the need for notches on the nose ring.

PAT.



Code No.	Milling Chuck	Slim Chuck	MAJOR DREAM	VC Holder
GH 6*	—	SK 6-P / SKT 6	MDSK 6	—
GH10*	—	SK10-P / SKT10	MDSK10	VC6
GH12*	C12-G	SK13-P / SKT13	MDSK13	—
GH16*	C16-G	SK16-P / SKT16	MDSK16	VC13
GH20*	C20-G	SK20-P / SKT20	MDSK20	—
GH25*	C25-G	SK25-P / SKT25	MDSK25	—
GH32S	C32-G(Nose Ring:φ62mm)	—	—	—
GH32	C32-G(Nose Ring:φ68mm)	—	—	—

★Torque adjustable GH Handle is available for * marked handle.
The Code No. is GH6-TLS, GH10-TLS, GH16-TLS, GH25-TLS.



Tightening



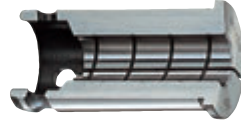
Loosening

STRAIGHT COLLET (KM COLLET)

NIKKEN

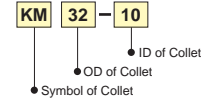


Photo shows ANNIVERSARY type KM Collet.



○ means with internal grooves for gripping strongly to eliminate the oil.

Explanation of the Code No.



KM : Standard
NK : Adjustable
CCK : Centre Coolant
CCNK : Centre Coolant, Adjustable

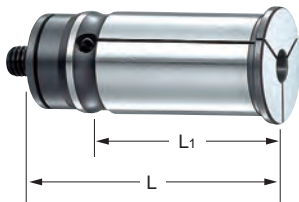
KM

Style	L	KM Collet Code No. (OD-ID)
KM12	40	KM12-2, 3, 4, 5, 6, 7, 8, 9, 10
KM16	47.5	KM16-2, 3, 4, 5, 6, 7, 8, 9, 10, 11, 12
KM20	53	KM20-2, 3, 4, 5, 6, 7, 8, 9, 10, 11, 12, 13, 14, 15, 16
KM22	57	KM22-3, 4, 5, 6, 7, 8, 9, 10, 11, 12, 13, 14, 15, 16, 17, 18, 19, 20
KM25	59	KM25-3, 4, 5, 6, 7, 8, 9, 10, 11, 12, 13, 14, 15, 16, 17, 18, 19, 20, 21, 22
KM32	64.5	KM32-3, 4, 5, 6, 7, 8, 9, 10, 11, 12, 13, 14, 15, 16, 17, 18, 19, 20, 21, 22, 23, 24, 25, 26, 30
KM42	73(78)	KM42-3, 4, 5, 6, 7, 8, 9, 10, 11, 12, 13, 14, 15, 16, 17, 18, 19, 20, 21, 22, 23, 24, 25, 26, 27, 28, 29, 30, 31, 32, 40

- ★ [For Synchronous Tapping Program] : Special ID Collets for Tap Shank are also available.
- ★ Other metric sizes and imperial sizes, 1/8, 1/4, 5/16, 3/8, 7/16, 1/2, 5/8, 3/4, 13/16, 7/8, 1, 1-1/8, 1-1/4, 1-1/2" are also available.
- ★ The collets with bold character are the "ANNIVERSARY" type KM Collet.
- Ordinary KM Collet can be used with "ANNIVERSARY" type Milling Chuck, but better performance can be found with the "ANNIVERSARY" type KM Collet.
- ★ Please note the acceptable shank tolerance is h6~h7.
- ★ () : L dimension for KM42-12 or larger ID.
- ★ Collet removal (9CCKR) is an optional accessory for NC milling chuck.

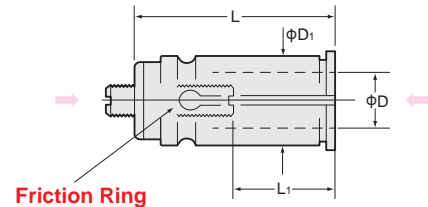
STRAIGHT COLLET (NK COLLET)

NIKKEN



NK

Cutter length adjustment on the collet is possible from front and back.



○ means with internal grooves for gripping strongly to eliminate the oil.

Style	L	L ₁	NK Collet Code No. (OD-ID)
NK20	63	20~40	NK20-3, 4, 5, 6, 7, 8, 9, 10, 11, 12, 13, 14, 15, 16
NK22	70	30~50	NK22-3, 4, 5, 6, 7, 8, 9, 10, 11, 12, 13, 14, 15, 16, 17, 18
NK25	68	30~55	NK25-3, 4, 5, 6, 7, 8, 9, 10, 11, 12, 13, 14, 15, 16, 17, 18, 19, 20, 21, 22
NK32	75	30~60	NK32-3, 4, 5, 6, 7, 8, 9, 10, 11, 12, 13, 14, 15, 16, 17, 18, 19, 20, 21, 22, 23, 24, 25, 26
NK42	85(92)	30~65	NK42-3, 4, 5, 6, 7, 8, 9, 10, 11, 12, 13, 14, 15, 16, 17, 18, 19, 20, 21, 22, 23, 24, 25, 26, 27, 28, 29, 30, 31, 32

- ★ [For Synchronous Tapping Program] : Special ID Collets for Tap Shank are also available.
- ★ Other metric sizes and imperial sizes, 1/8, 1/4, 5/16, 3/8, 7/16, 1/2, 5/8, 3/4, 13/16, 7/8, 1, 1-1/8, 1-1/4, 1-1/2" are also available.
- ★ The collets with bold character are standard.
- ★ Please note the acceptable shank tolerance is h6~h7.
- ★ () : L dimension for NK42-12 or larger ID.
- ★ Collet removal (9CCKR) is an optional accessory for NC milling chuck.

Straight Shank MILLING CHUCK

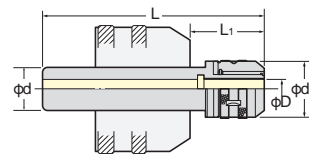
NIKKEN

S-C for Multi-Lock Milling Chuck

■ For Extension



Photo. shows S32-C12-200



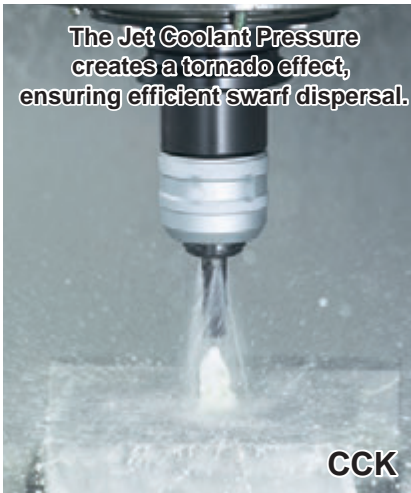
Style	Code No.	φd	φD	φd ₁	L	MAX. L ₁	Collet	Weight(kg)
32	S32-C12-120, 160, 200	32	12	33	120, 160, 200	60, 100, 140	KM12	0.6, 0.9, 1.1
	-C16-130		16	44	130	70	KM16	0.7
	-C20-150		20	52	150	90	KM20	1.1
42	S42-C16-180	42	16	44	180	120	KM16	1.6
	-C20-185		20	52	185	125	KM20	1.7

- ★ S32-C22-150, S42-C22-185, S42-C25-150 are also available as semi-standard.
- ★ The MC and NC straight shank Milling Chuck is unified to the above Code No. ★ Please refer P.31 for KM Collet.

CENTRE COOLANT STRAIGHT COLLET

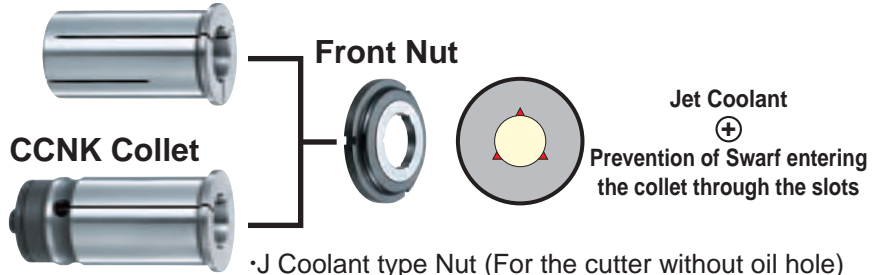
NIKKEN

BT

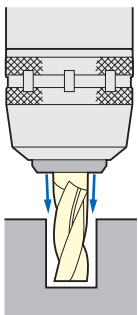


Suitable for all models of the NIKKEN MILLING CHUCK

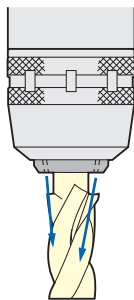
CCK Collet



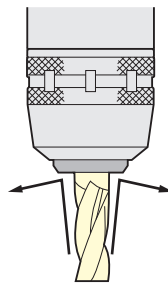
- J Coolant type Nut (For the cutter without oil hole)
- Nut with O-ring (For the oil hole cutter)
- Nut with multi coolant nozzles (For the cutter that the cutter dia. is larger than the shank dia.)



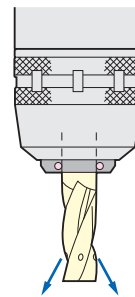
For grooving.



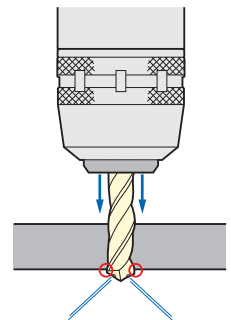
For cutters with cutting diameter which is larger than the shank diameter.



Prevention of the swarf contamination.



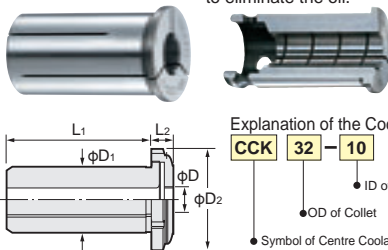
A front nut with an O-ring seal, for use with oil hole cutter, is also available as option.



Supply coolant to the shoulder when oil hole drill is passes through the hole.

CCK Collet

○ means with internal grooves for gripping strongly to eliminate the oil.



It can be used for the standard collet.

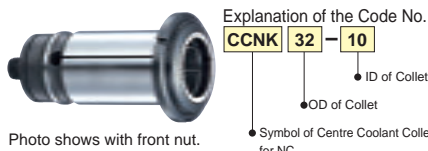
Style	φD1	φD2	L1	L2	CCK Collet Code No. (OD-ID)	Front Nut Code No.
CCK12	12	19.5	38	7	CCK12-3, 4, 5, 6, 8, 10	CKFN12
CCK16	16	28.5	45	8	CCK16-3, 4, 5, 6, 8, 10, 12	CKFN16
CCK20	20	33	50.5	8	CCK20-6, 8, 10, 12, 16	CKFN20
CCK25	25	39	56	8.5	CCK25-6, 8, 10, 12, 16, 20	CKFN25
CCK32	32	46.5, 43	61.5	9	CCK32-6, 8, 10, 12, 16, 20, 25	CKFN32, CKFN32T
CCK42	42	59.5	70(75)	9	CCK42-6, 8, 10, 12, 16, 20, 25, 32	CKFN42

- ★ Above bold figures indicate "ANNIVERSARY" type CCK Collet.
- ★ Please note the acceptable shank tolerance is h6~h7.
- ★ Other metric sizes and imperial sizes, 1/8, 1/4, 5/16, 3/8, 7/16, 1/2, 5/8, 3/4, 13/16, 7/8, 1, 1-1/8, 1-1/4, 1-1/2" are also available.
- ★ CKFN front nut and CCKL spanner are optional accessories.
- ★ Collet removal (9CKR) is an optional accessory for NC milling chuck.

CCNK Collet

○ means with internal grooves for gripping strongly to eliminate the oil.

Cutter length adjustment on the collet is possible from front and back.



It can be used for the standard collet.

Style	CCNK Collet Code No. (OD-ID)	Front Nut Code No.
CCNK20	CCNK20-6, 8, 10, 12, 16	CKFN20
CCNK25	CCNK25-6, 8, 10, 12, 16, 20	CKFN25
CCNK32	CCNK32-6, 8, 10, 12, 16, 20, 25	CKFN32, CKFN32T
CCNK42	CCNK42-6, 8, 10, 12, 16, 20, 25, 32	CKFN42

- ★ Please note the acceptable shank tolerance is h6~h7.
- ★ Other metric sizes and imperial sizes, 1/8, 1/4, 5/16, 3/8, 7/16, 1/2, 5/8, 3/4, 13/16, 7/8, 1, 1-1/8, 1-1/4, 1-1/2" are also available.
- ★ CKFN front nut and CCKL spanner are optional accessories.
- ★ Collet removal (9CKR) is an optional accessory for NC milling chuck.



★ Jet Coolant type for the cutter with a cutter dia. larger than shank dia. is also available.



CKFN25-20MN
32-25MN
42-32MN

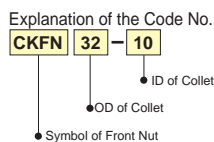
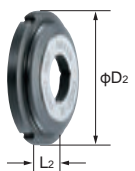
★ Front Nut fitted with an O-ring is also available. e.g. The Code No. is **CKFN32-10C**



★ The front nut for direct chucking is also available. e.g. **CKFN20-20D, CKFN25-25D, CKFN32-32D**

★ The Code No. fitted with O-ring is ; e.g. **CKFN20-20DC, CKFN25-25DC, CKFN32-32DC**

Front Nut



Style	φD2	L2	Front Nut Code No.
CKFN12	19.5	7	CKFN12 -3, 4, 5, 6, 8, 10
CKFN16	28.5	8	CKFN16 -3, 4, 5, 6, 8, 10, 12
CKFN20	33	8	CKFN20 -6, 8, 10, 12, 16
CKFN25	39	8.5	CKFN25 -6, 8, 10, 12, 16, 20
CKFN32	46.5	9	CKFN32 -6, 8, 10, 12, 16, 20, 25
CKFN32T	43	9	CKFN32T-6, 8, 10, 12, 16, 20, 25
CKFN42	59.5	9	CKFN42 -6, 8, 10, 12, 16, 20, 25, 32

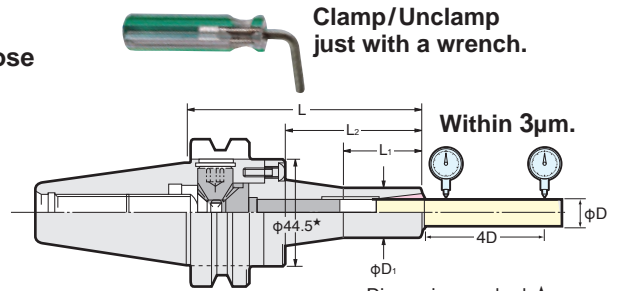
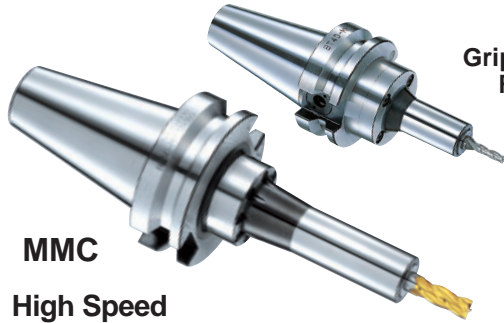
- ★ For C32 there are 2 sizes, CKFN32 = for nose ring diameter of φ69mm, CKFN32T = for nose ring diameter of φ64mm.
- ★ The spanner is available as an option.
- CKFN12 : CCKL12, CKFN16 : CCKL16, CKFN20 : CCKL20, CKFN25, CKFN32T : CCKL25, CKFN32 : CCKL32, CKFN42 : CCKL42

MINI-MINI CHUCK EXPERT for SMALL DIA. END MILLING



30,000min⁻¹ & G2.5
Gripping from Front Nose
Run-Out Accuracy :
3µm at 4D

Clamp/Unclamp
just with a wrench.



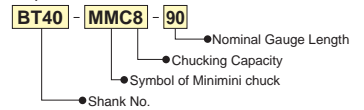
Dimension marked ★
is φ52.4 for MMC12.

MMC
High Speed

TAPER	Code No.	Chucking Range φD	L	φD ₁	L ₁	L ₂	Collet	MAX.min ⁻¹	Weight(kg)
No.30	BT30-MMC 4-105	1~ 4	105	15	30	43	MPK 4	30,000	0.9
	-MMC 8-105	2~ 8		20	36	42	PMK 8 VMK 8		0.9
	-MMC 12-105	4~12		30	35	44	PMK12 VMK12		1.1
No.40	BT40-MMC 4- 90	1~ 4	90	15	30	43	MPK 4	30,000	1.2
	-MMC 8- 90	2~ 8		20	36	42	PMK 8 VMK 8		1.2
	-120	4~12	120	43	72	PMK12 VMK12	1.3		
	-MMC 12- 90		90	30	35		44		1.4
No.50	BT50-MMC 4-105	1~ 4	105	15	30	43	MPK 4	20,000	3.8
	-MMC 8-105	2~ 8		20	36	42	PMK 8 VMK 8		3.8
	-135			135	43	72			3.9
	-165	4~12	165	43	102	PMK12 VMK12	4.0		
	-MMC 12-105		105	30	35		44		4.0
	-135	135	60	74	4.1				
	-165	165	70	104	4.2				

★Wrench is supplied as standard. Collet is available as an option.
 ★MMC12 is a NEW type, therefore, Old style collets for MMK12 can not be used with it. Please Use VMK12 or PMK12 Collets.
 ★Centre Coolant Through type MINI-MINI Chuck is available MMC8 and MMC12 type only.
 Please add the letter "C" to the Code No. e.g. BT40-MMC8C-90 P.106
 ★MPK, PMK, VMK collet is available as an option. Please refer P.32

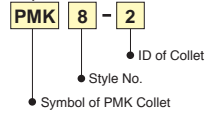
Explanation of the Code No.



PMK Collet Please select PMK collet for the MINI-MINI Chuck without coolant through capability.



Explanation of the Code No.



PMK Collet Code No.
MPK 4-1, 1.5, 2, 2.5, 3, 3.5, 4
PMK 8-2, 2.2, 2.4, . . . 3, . . . 4, . . . 5, . . . 6, . . . 7, . . . 8 (each 0.2mm)
PMK12-4, 5, 6, 8, 10, 12

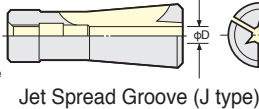
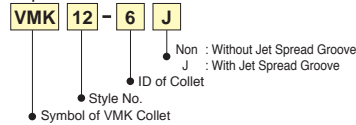
★Please note the acceptable shank tolerance of MPK Collet is h₈.
 ★Even the gripping range of PMK collet is 0.2mm/dia. (e.g. PMK8-2 : 1.8~2.0),
 but the shank tolerance of h₈ is highly recommended for precision machining.

VMK, VMK-J Collet For centre through tool coolant type MINI-MINI Chuck ;

- Standard VMK collet is for the cutting tool with coolant hole.
- VMK-J collet is for the cutting tool without coolant hole.



Explanation of the Code No.



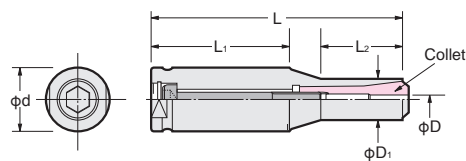
VMK Collet Code No.
VMK 8-2J,3J,4J,5J,6J,8J
VMK12-4J,5J,6J,8J,10J,12J

★Please note the acceptable shank tolerance is h₈.
 ★VMK8-2J is Jet Spread Hole type.

Straight Shank MINI-MINI CHUCK



K-MMC



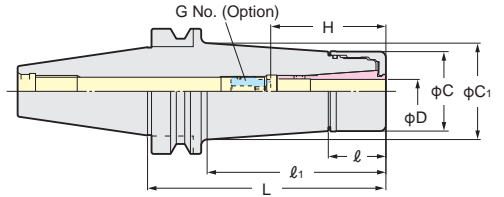
Style	Code No.	Chucking Range φD	L	φD ₁	L ₁	L ₂	Collet	Weight(kg)
16	K16-MMP 4- 70, 150	1~ 4	70, 150	15	50, 130	20	MPK 4	0.1, 0.2
20	K20-MMC 8-100	2~ 8	100	20	80	20	PMK 8 VMK 8	0.2
32	K32-MMC 8-122, 160	2~ 8	122, 160	20	67	40	PMK 8 VMK 8	0.5, 0.7
	K32-MMC12-170S	4~12	170	30	120	50	PMK12 VMK12	1.0

★Wrench is supplied as standard. Collet is available as an option.

ANNIVERSARY TYPE VC HOLDER



With TiN Bearing Nut
MAX. 40,000min⁻¹ & G2.5
 Run-Out Accuracy : Within 3μm at 4D

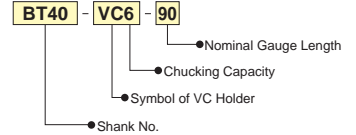


High Speed

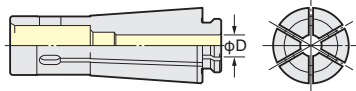
TAPER	Code No.	D	L	ℓ	ℓ ₁	C	C ₁	H	G No. (Option)	Weight (kg)	MAX. min ⁻¹	Collet
No.30	BT30-VC 6- 45	2.0~ 6.0	45	23	23	27.5	27.5	35~45	VCG 6- 8A	0.5	40,000	VCK 6
	- 60		60		35		31.7			0.6		
	- 90		90		65		33.4			0.8		
	-VC13- 60	3.0~12.0	60	37	41.1	0.7						
	- 90		90	67	41.3	0.9						
-120	120	97	42.4	1.2								
No.40	BT40-VC 6- 60	2.0~ 6.0	60	23	30	27.5	30.0	35~45	VCG 6- 8A	1.1	30,000	VCK 6
	- 90		90		60		32.7			1.3		
	-120		120		90		36.9			1.5		
	-VC13- 60	3.0~12.0	60	31	40.3	1.2						
	- 90		90	60	44.3	1.5						
-120	120	90	48.5	1.9								
No.50	BT50-VC 6-105	2.0~ 6.0	105	23	62	27.5	33.0	35~45	VCG 6- 8A	3.9	20,000	VCK 6
	-135		135		92		37.1			4.1		
	-165		165		122		41.3			4.4		
	-VC13-105	3.0~12.0	105	62	44.6	4.1						
	-135		135	92	48.8	4.5						
-165	165	122	53.0	4.9								

- ★TiN Bearing Nut is supplied as standard.
- ★Collet, adjust screw (G No.) and GH Handle are available as an option. The Code No. of the GH Handle is VC6: GH10, VC13: GH16
- ★Please add "-RP" at the end of Code No. for Rust Proof Treatment VC Holder. e.g : BT40-VC13-60-RP
- ★Please use VC J type Nut & Cap for Centre Through Coolant. When VC J type Nut is used, the total holder length will be extended to 6mm.
- ★BT40-VC 6-150, BT40-VC13-150, BT50-VC13- 90, -120 are available as semi-standard.
- ★When the axial stopper is required, please use Adjust Screw (G No.)
- ★All series are for High Speed Rotation.

Explanation of the Code No.



VCK Collet



VCK Collet Code No.
VCK 6-2, 3, (3.175), 4, 5, 6
VCK13-3, (3.175), 4, 5, 6, 7, 8, 9, 10, 11, 12

- ★The acceptable shank tolerance of VCK collet is h₈.
- ★Inch series is also available.
- VCK 6-1/8, 3/16, 1/4 VCK13-1/8, 3/16, 1/4, 5/16, 3/8, 7/16, 1/2
- ★VCK6-3.175 is same as VCK6-1/8.
- ★VCK13-3.175 is same as VCK13-1/8.

Jet coolant splash with J type Nut.

J type Nut Code No.
 VC 6 : VCN- 6BJ
 VC13 : VCN-13BJ



Cap & Wrench Code No.
 VC 6 type Cap, Wrench : SKJ10-□, SKJL-10
 VC13 type Cap, Wrench : SKJ16-□, SKJL-16
 The caps and wrench of SK10 type and SK16 type can be used for VC6 type and VC13 type respectively.



Cap with triangular grooves
 The jet coolant pressure creates a tornado effect.

Cap with O-ring
 For oil hole cutting tool

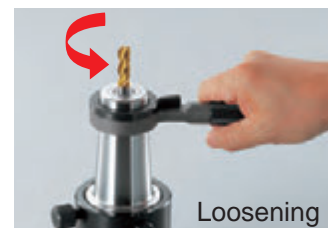


Easy, safe and reliable handling with GH Handle

The nut has no notches for high speed rotation and GH Handle can tighten the nut with half of the tightening torque of the conventional C type spanner, thus, substantial improvement for quality of safety, reliability and operational efficiency will be obtained. reliability and operational efficiency will be obtained.

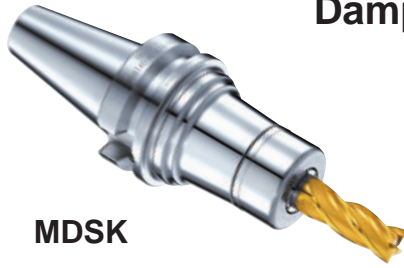


GH Handle Code No.
 VC 6 : GH10
 VC13 : GH16



Holder with an adjust screw for axial adjustment is supplied as an option. Please contact us.

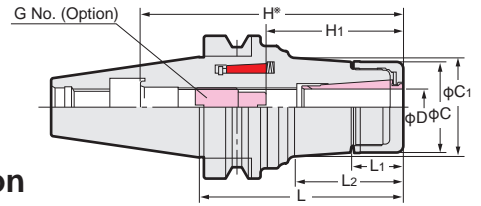
**Dampening Effect
TiN Bearing Effect**



MDSK

NEW

**MDSK6 Series Addition
MDSK13**



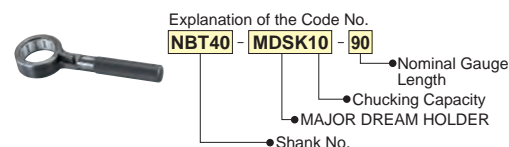
H : MAX. Cutter Shank Length to be inserted

2LOCK tool can be used on the M/C with BT standard spindle.

PAT.

TAPER	Code No.	D	L	L1	L2	C	C1	H*	H1	G No. (Option)	Weight (kg)	Collet
No.30	NBT30-MDSK 6- 50	3.0~6.0	50	16.2	19.5	19.5	20.0	73	21~35	SKG- 8	0.5	SK 6 A
	- 60		60		25.5		83	0.6				
	- 75		75		40.5		98	0.7				
	- 90		90		55.5		113	0.8				
	-MDSK10- 50	3.0~10.0	50	18.0	19.0	27.5	27.5	72	30~50	SKG-12L	0.5	SK10 A
	- 60		60		25.7		82	0.6				
	- 75		75		42.9		97	0.8				
	- 90		90		58.7		112	0.8				
	-MDSK13- 60	3.0~13.0	60	22.0	29.0	33.0	34.0	83	31~43	SKG-15	0.8	SK13 A
	- 75		75		45.0		98	0.8				
	- 90		90		60.0		113	0.8				
	-MDSK16- 75	3.0~16.0	75	23.0	47.5	40.0	60	60	45~60	SKG-12L	1.1	SK16 A
- 90	90		62.5		40.0		75	45~70	SKG-12	1.3		
No.40	NBT40-MDSK 6- 60	3.0~6.0	60	16.2	18.0	19.5	19.5	86	21~35	SKG- 8	0.8	SK 6 A
	- 75		75		33.0		101	0.9				
	- 90		90		48.0		116	1.1				
	-105		105		63.0		131	1.2				
	-120	120	78.0	146	1.4							
	-MDSK10- 60	3.0~10.0	60	18.0	19.0	27.5	27.5	86	30~50	SKG-12L	1.1	SK10 A
	- 75		75		33.0		101	1.3				
	- 90		90		48.0		116	1.5				
	-105		105		63.0		131	1.6				
	-120	120	78.0	146	1.8							
	-150	150	110.0	176	2.2							
	-MDSK13- 65	3.0~13.0	65	22.0	24.0	33.0	33.0	91	31~60	SKG-15	1.2	SK13 A
	- 75		75		33.0		101	1.4				
	- 90		90		48.0		116	1.7				
	-105		105		63.0		131	1.8				
	-120	120	78.0	146	2.0							
	-150	150	110.0	176	2.4							
	-180	180	144.0	206	2.6							
	-MDSK16- 65	3.0~16.0	65	23.0	24.0	40.0	40.0	91	45~60	SKG-18L	1.2	SK16 A
	- 75		75		33.0		101	1.5				
	- 90		90		48.0		116	1.9				
	-105		105		64.0		131	2.0				
	-120	120	80.0	146	2.2							
	-150	150	113.0	176	2.5							
-MDSK20- 75	4.0~20.0	75	25.2	41.2	48.0	51.3	80	50~73	SKG-12	1.9	SK20 A	
- 90		90		55.0		95	SKG-12-55L		2.1			
-105		105		70.0		110	SKG-12-70L		2.3			
-120		120		85.0		125	SKG-12-85L		2.6			

- ★Please use A type SK collet for the end milling operation. (P.39)
- ★Please refer P.43, P.44 for the Jet coolant system, J type nut and cap.
- ★GH handle is available as an option. (P.30) Please order with the Code No. GH6 : MDSK6 &, GH10 : MDSK10, GH16 : MDSK16, GH20 : MDSK20, GH25 : MDSK25
- ★Please add "P" at the end of Code No. for high speed specification, e.g NBT40-MDSK10-60P
- ★Holder with an adjust screw for axial adjustment is supplied as an option. Please contact us.

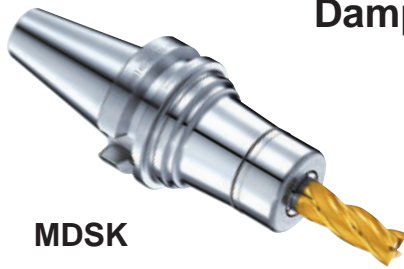


MAX. min⁻¹

Code No.	MAX. min ⁻¹	Code No.	MAX. min ⁻¹	Code No.	MAX. min ⁻¹
NBT30-MDSK 6-P	30,000	NBT40-MDSK 6-P	25,000	NBT50-MDSK 6-P	20,000
-MDSK10-P		-MDSK10-P		-MDSK13-P	
-MDSK13-P		-MDSK13-P		-MDSK16-P	
-MDSK16-P	25,000	-MDSK16-P	20,000		
		-MDSK20-P			
		-MDSK25-P		15,000	

Holder with an adjust screw for axial adjustment is supplied as an option. Please contact us.

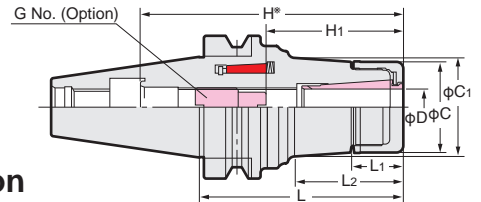
Dampening Effect
TiN Bearing Effect



MDSK

NEW

MDSK6 Series Addition
MDSK13



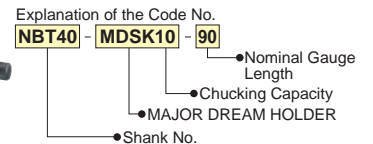
H : MAX. Cutter Shank Length to be inserted

2LOCK tool can be used on the M/C with BT standard spindle.

PAT.

TAPER	Code No.	D	L	L1	L2	C	C1	H*	H1	G No. (Option)	Weight (kg)	Collet	
No.50	NBT50-MDSK 6-105	3.0~6.0	105	16.2	48.0	19.5	24.0	116	21~35	SKG- 8	3.6	SK 6 A	
	-120		120		63.0		26.1				131		3.7
	-MDSK10-105	3.0~10.0	105	18.2	48.0	27.5	31.7	116	30~50	SKG-12L	4.3	SK10 A	
	-120		120		63.2		33.8				131		4.4
	-135		135		78.2		35.9				146		4.7
	-165		165		110.2		40.4				176		5.0
	-195	195	141.2	44.8	206	5.3							
	-MDSK13-105	3.0~13.0	105	22.0	48.0	33.0	36.7	116	31~60	SKG-15	4.2	SK13 A	
	-120		120		63.0		38.8				131		4.7
	-135		135		78.0		40.9				146		5.0
	-165		165		110.0		45.4				176		5.3
	-195		195		144.0		50.1				206		5.6
	-MDSK16-105	3.0~16.0	105	23.0	48.0	40.0	43.5	116	45~70	SKG-18L	4.1	SK16 A	
	-120		120		64.0		45.8				131		4.9
	-135		135		80.1		48.0				146		5.2
	-165		165		114.7		52.6				176		5.5
	-195		195		144.6		52.8				206		5.8
	-MDSK20-105	4.0~20.0	105	25.2	42.3	48.0	51.4	159	47~80	SKG-22	4.9	SK20 A	
	-135		135		72.0		55.6				175		5.3
	-165		165		102.0		59.8				205		5.9
	-195		195		132.0		64.0				235		6.7
	-MDSK25-105	8.0~25.4	105	27.0	42.3	55.0	57.2	159	55~85	SKG-28	4.9	SK25 A	
	-135		135		74.0		61.6				175		5.7
	-165		165		105.0		66.0				205		6.5
-195	195		135.0		70.2		235				7.5		

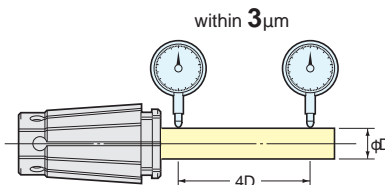
- ★Please use A type SK collet for the end milling operation. (P.39)
- ★Please refer P.43, P.44 for the Jet coolant system, J type nut and cap.
- ★GH handle is available as an option. (P.30) Please order with the Code No. GH6 : MDSK6 &, GH10 : MDSK10, GH16 : MDSK16, GH20 : MDSK20, GH25 : MDSK25
- ★Please add "P" at the end of Code No. for high speed specification, e.g NBT40-MDSK10-60P
- ★Holder with an adjust screw for axial adjustment is supplied as an option. Please contact us.



A TYPE SLIM COLLET



SK



SK Collet A Type
SK 6-3A, 3.175A, 4A, 5A, 6A
SK10-3A, 3.175A, 4A, 5A, 6A, 8A, 10A
SK13-3A, 4A, 5A, 6A, 8A, 10A, 12A
SK16-3A, 4A, 5A, 6A, 8A, 10A, 12A, 16A
SK20-4A, 5A, 6A, 8A, 10A, 12A, 16A, 20A
SK25-8A, 10A, 12A, 16A, 20A, 25A

★The acceptable shank tolerance of A Type collet is h8.

SLIM CHUCK HIGH SPEED ROTATION • HIGH ACCURACY

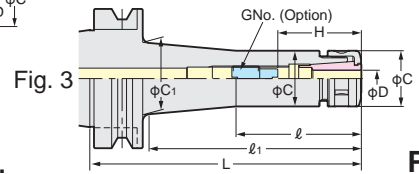
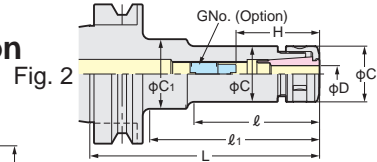
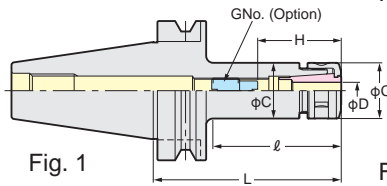
NIKKEN

NEW SK13, SK20 Series Addition



SK

Photo shows SK10 type.



When SK J type nut is used, the total chuck length will be extended by 6mm.

PAT.

TAPER	Code No.	D	L	l	l ₁	C	C ₁	H	G No. (Option)	Weight (kg)	Fig	SK Collet
No.30	BT30-SK 6- 60	0.7 ~ 6.0	60	33	33	19.5	19.5	21~35	SKG- 8	0.7	1	SK 6
	- 90		90	56	65		32			0.7	2	
	-120		120	62	95	32	0.8					
	-SK10- 45	1.75~10.0	45	22	22	27.5	27.5	30~50	SKG-12S	0.8	1	SK10
	- 60		60	35	35					0.9		
	- 75		75	50	50					1.0		
	- 90		90	65	65					1.0		
	-120	120	95	95	1.1							
	-SK13- 60	2.75~13.0	60	35	35	33	33	31~50	SKG-15	1.0	1	SK13
	- 75		75	50	50					1.1		
	- 90		90	65	65					1.1		
	-120	120	95	95	1.2							
	-SK16- 60	2.75~16.0	60	37	37	40	40	45~60	SKG-12L	1.1	1	SK16
	- 75		75	52	52			1.2				
	- 90		90	67	67			1.2				
	-120		120	97	97			1.3				
	-SK20- 60	3.5~20.0	60	37	37	48.5	48.5	65~70	SKG-12S	0.7	1	SK20
	- 75		75	52	52			0.9				
	- 90		90	67	67			1.2				
	-SK25- 90	7.5~25.4	90	67	67	55	55	55~75	SKG-12	1.5	1	SK25
No.40	BT40-SK 6- 60	0.7 ~ 6.0	60	30	30	19.5	19.5	21~35	SKG- 8	1.0	1	SK 6
	- 90		90	51	60		32			1.1	2	
	-120		120	60	90	25	1.4					
	-150		150	60	120	25	1.5			3		
	-SK10- 60	1.75~10.0	60	32	32	27.5	27.5	30~50	SKG-12L	1.1	1	SK10
	- 75		75	45	45					1.2		
	- 90		90	48	60					1.2		
	-120		120	90	90					1.4		
	-150		150	118	118	1.6	2					
	-180		180	73	148	1.6						
	-200		200	168	168	1.8	3					
	-250		250	218	218	2.1						
	-SK13- 60	2.75~13.0	60	28	28	33	33	31~65	SKG-15	1.2	1	SK13
	- 75		75	43	43					1.3		
	- 90		90	58	58					1.4		
	-120		120	88	88					1.6		
	-150		150	118	118	1.8	3					
	-180		180	88	148	1.8						
	-200		200	168	168	2.0						
	-250		250	218	218	2.4						
	-SK16- 60	2.75~16.0	60	32	32	40	40	50~65	SKG-18S	1.3	1	SK16
	- 75		75	43	43			1.4				
	- 90		90	58	58			1.5				
	-120		120	88	88			1.7				
	-150		150	118	118	1.9	40~70					
	-180		180	148	148	2.0						
	-200		200	168	168	2.2						
	-250		250	218	218	2.7						
	-SK20- 60	3.5~20.0	60	32	32	48.5	48.5	47~60	SKG-22	1.3	1	SK20
	- 75		75	45	45			1.4				
	- 90		90	60	60			1.6				
	-120		120	90	90			2.0				
-SK25- 75	7.5~25.4	75	47	47	55	55	55~75	SKG-12	1.7	1	SK25	
- 90		90	61	61			1.8					
-120		120	91	91			2.0					
-SK25- 90	7.5~25.4	90	61	61	55	55	55~85	SKG-28	1.8	1	SK25	
-120	120	91	91	91	55	55	55~85	SKG-28	2.0	1	SK25	

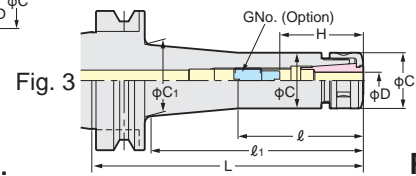
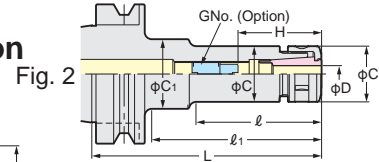
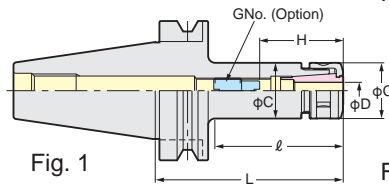
SLIM CHUCK HIGH SPEED ROTATION • HIGH ACCURACY

NIKKEN



SK
Photo shows SK16 type.

NEW SK13, SK20 Series Addition



When SK J type nut is used, the total chuck length will be extended by 6mm.

PAT.

TAPER	Code No.	D	L	l	l ₁	C	C ₁	H	G No. (Option)	Weight (kg)	Fig	SK Collet
No.50	BT50-SK 6-105	0.7 ~ 6.0	105	55	64	19.5	32	21~35	SKG- 8	3.8	2	SK 6
	-135		135		92					3.9		
	-165		165	60	114					4.0		
	-200		200		151					4.2		
	-SK10-105	1.75~10.0	105	57	57	27.5	32	30~50	SKG-12L	4.2	1	SK10
	-135		135	70	92					4.4		
	-165		165		114					4.6		
	-200		200		151					4.8		
	-225	225	75	178	5.0	3	3	SKG-12L	5.2			
	-250	250		203	5.6							
	-300	300		253	5.6							
	-SK13-105	2.75~13.0	105	62	62	33	33	31~65	SKG-15	4.5	1	SK13
	-135		135		92					4.7		
	-165		165		122					4.9		
	-200		200	92	157					5.2		
	-250	250		207	5.7	3	3	SKG-15	6.2			
	-300	300		257	6.2							
	-SK16-105	2.75~16.0	105	62	62				40	40	40~70	SKG-18L
	-135		135	92	92	4.9						
	-165		165		122	5.1						
	-200		200	90	157	5.5						
	-250	250		207	6.0	3	3	SKG-18L	6.5			
	-300	300		257	6.5							
	-SK20-105	3.5~20.0	105	62	62				48.5	48.5	47~80	SKG-22
	-135		135	92	92	4.6						
	-165		165	122	122	5.0						
	-200		200	157	157	5.4						
	-250	250	207	207	6.1	1	1	SKG-22	6.8			
-300	300	257	257	6.8								
-SK25-105	7.5~25.4	105	62	62	55				55	50~85	SKG-28	5.2
-135		135	92	92		5.4						
-165		165	122	122		5.6						
-200		200	157	157		6.0						
-250	250	207	207	6.7	1	1	SKG-28	7.4				
-300	300	257	257	7.4								

- ★Please refer P.57 for use as Tap Holder for Synchronized Tapping.
- ★Collet, adjust screw (G No.) and spanner are available as an option.
- The Code No. of the spanner is SK6 (C=φ18) : SKL-6, SK6 (C=φ19.5) : SKL-6W, SK10: SKL-10, SK13: 9HC12A, SK16: 9HC16, SK20: 9HC22, SK25: 9HC25
- ★Please refer P.41, P.42 for High Speed Slim Chuck (40,000min⁻¹)
- ★All Slim Chucks can be used for Centre Through Coolant type. Please refer P.44 for Centre Through Coolant Adjust Screw and P.240 for Centre Through Pull Stud.
- ★Please refer P.105 for High Pressure (MAX.7MPa) Centre Through Coolant type. ★Please refer P.107 for Flange Through Coolant type.
- ★BT40-SK10-200, 250 BT50-SK10-250, 300 are also available as semi-standard.
- SK16-200, 250 -SK16-250, 300
- ★Please add "-RP" at the end of Code No. for Rust Proof Treatment Slim Chuck. e.g. BT40-SK10-90-RP



BT15 Shank

TAPER	Code No.	D	L	l	l ₁	C	C ₁	H	G No. (Option)	Weight (kg)	Fig	SK Collet	
No.15	BT15BR-SK 6- 40	0.7 ~ 6.0	40	26	26	19.5	19.5	21~30	SKG- 6	0.10	1	SK 6	
	- 55		55	39	39			21~35	SKG- 8	0.14			
	- 65		65	49	49					0.15			
	-SK10- 40	1.75~10.0	40	26	26	27.5	27.5	30~37	SKG- 6L	0.14			SK10
	- 55		55	41	41			35~45		0.20			

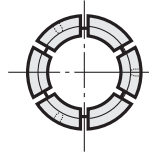
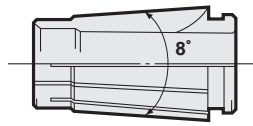
- ★BT15BR is the solid tool integrated with pull stud for BROTHER.
- ★BT15HW is the solid tool integrated with pull stud for HOWA.
- ★BT20P and BT25M are the solid tools with integrated with pull stud without drive key groove for MAKINO SEIKI. e.g. BT20P-SK10-40S, BT25M-SK16-70
- ★S20T is the short taper tool for SUGINO.



BT15BR

B1

SLIM CHUCK COLLET



Explanation of the Code No.

SK 10 - 6 P

- Non: Standard
- P: P class (Run-out Accuracy=3μm)
- A: A type (for End Mill Shank)
- MAX. Chucking Dia.
- Style No.
- Symbol of SK Collet

SK "A" type SK collet (for End Mill Shank) are marked **P**. The acceptable shank tolerance is h8. Code No. is e.g. SK10-10A
 "P" class SK collet (for drill) are available for all series. e.g. SK10-10P

Code No.	Chucking D
SK 6- 0.8	0.7 ~ 0.8
- 1	0.9 ~ 1.0
- 1.25	1.15~ 1.25
- 1.5	1.3 ~ 1.5
- 1.75	1.55~ 1.75
- 2	1.8 ~ 2.0
- 2.25	2.05~ 2.25
- 2.5	2.3 ~ 2.5
- 2.75	2.55~ 2.75
- 3	2.8 ~ 3.0
- 3.5	3.0 ~ 3.5
- 4	3.5 ~ 4.0
- 4.5	4.0 ~ 4.5
- 5	4.5 ~ 5.0
- 5.5	5.0 ~ 5.5
- 6	5.5 ~ 6.0
SK10- 2	1.75~ 2.0
- 2.25	2.0 ~ 2.25
- 2.5	2.25~ 2.5
- 2.75	2.5 ~ 2.75
- 3	2.75~ 3.0
- 3.5	3.0 ~ 3.5
- 4	3.5 ~ 4.0
- 4.5	4.0 ~ 4.5
- 5	4.5 ~ 5.0
- 5.5	5.0 ~ 5.5
- 6	5.5 ~ 6.0
- 6.5	6.0 ~ 6.5
- 7	6.5 ~ 7.0
- 7.5	7.0 ~ 7.5
- 8	7.5 ~ 8.0
- 8.5	8.0 ~ 8.5
- 9	8.5 ~ 9.0
- 9.5	9.0 ~ 9.5
- 10	9.5 ~ 10.0

Code No.	Chucking D
SK13- 3	2.75~ 3.0
- 3.5	3.0 ~ 3.5
- 4	3.5 ~ 4.0
- 4.5	4.0 ~ 4.5
- 5	4.5 ~ 5.0
- 5.5	5.0 ~ 5.5
- 6	5.5 ~ 6.0
- 6.5	6.0 ~ 6.5
- 7	6.5 ~ 7.0
- 7.5	7.0 ~ 7.5
- 8	7.5 ~ 8.0
- 8.5	8.0 ~ 8.5
- 9	8.5 ~ 9.0
- 9.5	9.0 ~ 9.5
- 10	9.5 ~ 10.0
- 10.5	10.0~ 10.5
- 11	10.5~ 11.0
- 11.5	11.0~ 11.5
- 12	11.5~ 12.0
- 12.5	12.0~ 12.5
- 13	12.5~ 13.0

Code No.	Chucking D
SK16- 3	2.75~ 3.0
- 3.5	3.0 ~ 3.5
- 4	3.5 ~ 4.0
- 4.5	4.0 ~ 4.5
- 5	4.5 ~ 5.0
- 5.5	5.0 ~ 5.5
- 6	5.5 ~ 6.0
- 6.5	6.0 ~ 6.5
- 7	6.5 ~ 7.0
- 7.5	7.0 ~ 7.5
- 8	7.5 ~ 8.0
- 8.5	8.0 ~ 8.5
- 9	8.5 ~ 9.0
- 9.5	9.0 ~ 9.5
- 10	9.5 ~ 10.0
- 10.5	10.0~ 10.5
- 11	10.5~ 11.0
- 11.5	11.0~ 11.5
- 12	11.5~ 12.0
- 12.5	12.0~ 12.5
- 13	12.5~ 13.0
- 13.5	13.0~ 13.5
- 14	13.5~ 14.0
- 14.5	14.0~ 14.5
- 15	14.5~ 15.0
- 15.5	15.0~ 15.5
- 16	15.5~ 16.0

Code No.	Chucking D
SK20- 4	3.5 ~ 4.0
- 4.5	4.0 ~ 4.5
- 5	4.5 ~ 5.0
- 5.5	5.0 ~ 5.5
- 6	5.5 ~ 6.0
- 6.5	6.0 ~ 6.5
- 7	6.5 ~ 7.0
- 7.5	7.0 ~ 7.5
- 8	7.5 ~ 8.0
- 8.5	8.0 ~ 8.5
- 9	8.5 ~ 9.0
- 9.5	9.0 ~ 9.5
- 10	9.5 ~ 10.0
- 10.5	10.0~ 10.5
- 11	10.5~ 11.0
- 11.5	11.0~ 11.5
- 12	11.5~ 12.0
- 12.5	12.0~ 12.5
- 13	12.5~ 13.0
- 13.5	13.0~ 13.5
- 14	13.5~ 14.0
- 14.5	14.0~ 14.5
- 15	14.5~ 15.0
- 15.5	15.0~ 15.5
- 16	15.5~ 16.0
- 16.5	16.0~ 16.5
- 17	16.5~ 17.0
- 17.5	17.0~ 17.5
- 18	17.5~ 18.0
- 18.5	18.0~ 18.5
- 19	18.5~ 19.0
- 19.5	19.0~ 19.5
- 20	19.5~ 20.0

Code No.	Chucking D
SK25- 8	7.5~ 8.0
- 10	9.5~ 10.0
- 12	11.5~ 12.0
- 16	15.5~ 16.0
- 16.5	16.0~ 16.5
- 17	16.5~ 17.0
- 17.5	17.0~ 17.5
- 18	17.5~ 18.0
- 18.5	18.0~ 18.5
- 19	18.5~ 19.0
- 19.5	19.0~ 19.5
- 20	19.5~ 20.0
- 20.5	20.0~ 20.5
- 21	20.5~ 21.0
- 21.5	21.0~ 21.5
- 22	21.5~ 22.0
- 22.5	22.0~ 22.5
- 23	22.5~ 23.0
- 23.5	23.0~ 23.5
- 24	23.5~ 24.0
- 24.5	24.0~ 24.5
- 25	24.5~ 25.0
- 25.4	25.0~ 25.4

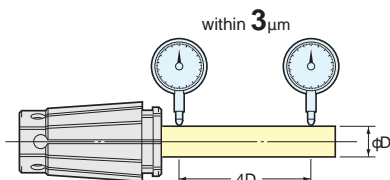
★SK6 collet with the special internal dia. is also available.



Collet removal (SKR-6) is supplied as standard only for SK6. SKR-10, SKR-16 and SKR-25 are available as an option. Collet removal is not necessary for the new types of collet (SK10 to SK25 collet including SK13 and SK20).

“P” class SK collet for drill

It guarantees the Run-out accuracy within 3 micron at the nose (4D) from the chuck. Additionally Collet Set is also available.



“A” type SK collet for endmill

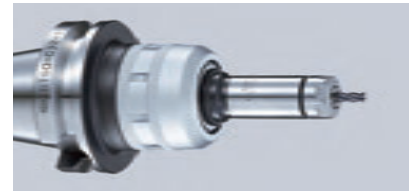
The acceptable shank tolerance is h8.

SK Collet A type
SK 6-3A, 3.175A, 4A, 5A, 6A
SK10-3A, 3.175A, 4A, 5A, 6A, 8A, 10A
SK13-3A, 4A, 5A, 6A, 8A, 10A, 12A
SK16-3A, 4A, 5A, 6A, 8A, 10A, 12A, 16A
SK20-4A, 5A, 6A, 8A, 10A, 12A, 16A, 20A
SK25-8A, 10A, 12A, 16A, 20A, 25A

Straight Shank SLIM CHUCK



Suitable for Multi-Lock Milling Chuck



K-SK

Explanation of the Code No.

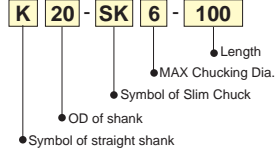


Fig. 1

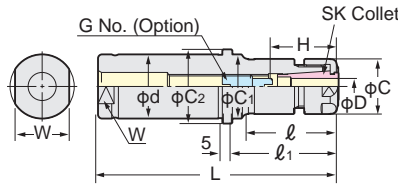
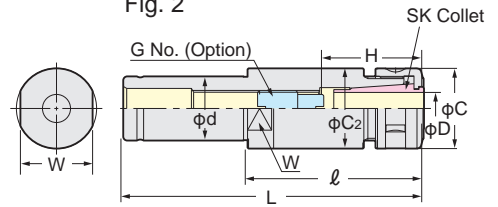


Fig. 2



Code No.	D	ℓ	ℓ ₁	C	C ₁	C ₂	W	H	G No. (Option)	Weight (kg)	Fig	SK Collet
K20-SK 6-100, 120	0.7~6.0	37, 57		19.5		27	18	21~35	SKG-8	0.2, 0.2	1	SK 6
-SK10-100, 120	1.75~10.0	40, 60		27.5		27.5	18	30~50	SKG-12L	0.3, 0.3	2	SK10
K22-SK 6-100, 120	0.7~6.0	37, 57		19.5		27	19	21~35	SKG-8	0.2, 0.2	1	SK 6
-SK10-100, 120	1.75~10.0	40, 60		27.5		27.5	19	30~50	SKG-12L	0.3, 0.3	2	SK10
K25-SK 6-100, 130	0.7~6.0	32, 62		19.5			30	21~35	SKG-8	0.3, 0.3		SK 6
-SK10-120, 150	1.75~10.0	50, 80		27.5			22	30~50	SKG-12L	0.4, 0.5		SK10
K32-SK 6-120, 140, 170	0.7~6.0	45, 65, 63	53, 73, 100	19.5	32, 32, 24			21~35	SKG-8	0.5, 0.5, 0.5	1	SK 6
-SK10-120, 150, 180, 210	1.75~10.0	45, 75, 75, 75	53, 83, 111, 141	27.5	32, 32, 31.5, 33.5	37	27	30~50	SKG-12L	0.6, 0.7, 0.8, 1.0		SK10
-SK13-120, 150, 180, 210	2.75~13.0	52, 82, 112, 142		33				31~65	SKG-15	0.7, 0.8, 1.0, 1.2		SK13
-SK16-120, 150, 180, 210	2.75~16.0	58, 88, 118, 148		40		40	36	45~70	SKG-18L	0.7, 0.9, 1.2, 1.4		SK16
-SK20-120, 150, 180	3.5~20.0	58, 88, 118		48.5		40	41	47~80	SKG-22	0.9, 1.3, 1.7	2	SK20
-SK25-150	7.5~25.4	88		55		42	46	55~65	SKG-18L	1.3		SK25
K42-SK 6-150, 170	0.7~6.0	52, 62	61, 78	19.5	32			21~35	SKG-8	1.0, 1.1		SK 6
-SK10-150, 180	1.75~10.0	56, 78		27.5				30~50	SKG-12L	1.1, 1.3		SK10
-SK13-150, 180	2.75~13.0	56, 86		33				31~65	SKG-15	1.2, 1.4	1	SK13
-SK16-150, 180	2.75~16.0	58, 88		40				45~70	SKG-18L			SK16
-SK20-150, 180	3.5~20.0	68, 98		48.5		48.5	36	47~80	SKG-22	1.5, 1.9		SK20
-SK25-170	7.5~25.4	88		55		44.5	46	55~65	SKG-18L	1.8	2	SK25

★Collet, adjust screw (G No.) and spanner are available as an option.

The Code No. of the spanner is SK6 (C=φ18) : SKL-6, SK6 (C=φ19.5) : SKL-6W, SK10: SKL-10, SK13: 9HC12A, SK16: 9HC16, SK20: 9HC22, SK25: 9HC25

★Please refer P.39 for SK Collet.

★All Slim Chucks are Centre Through Coolant type.

★Please refer P.44 for adjust screw (G No.).

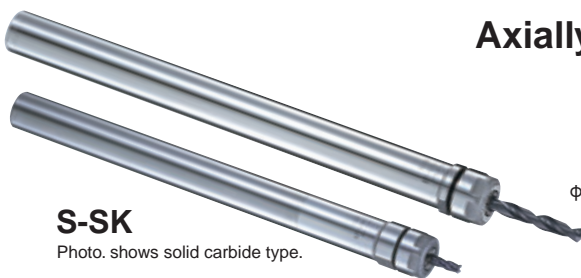


Straight Shank SLIM CHUCK ULTRA LONG TYPE



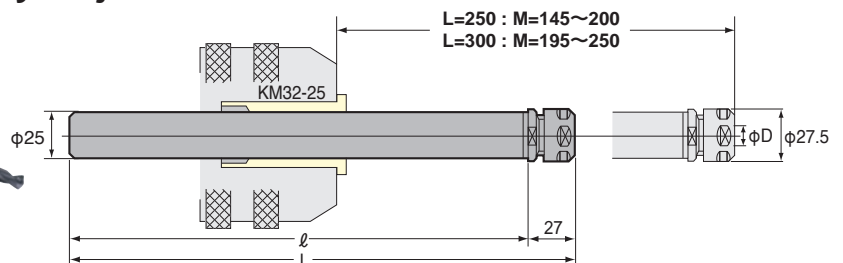
ULTRA LONG SLIM CHUCK

Axially Adjustable



S-SK

Photo. shows solid carbide type.



Solid Carbide type is also available.

Please add "X" to the Code No. e.g. S25-SK10X-250, S25-SK10X-300

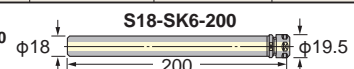
	Code.No.	Chucking Range D	Length L	ℓ	Over Hang Length M	G No. (Option)	Weight (kg)	Collet
25	S25-SK10-250	1.75~10.0	250	223	145~200	SKG-12S	0.9	SK10
	S25-SK10-300		300	273	195~250		1.1	

★Nut, Adjust Screw (G No.) and Collet Extractor are supplied as standard.

★Spanner "SKL-10" is available as an option.

★Please refer P.39 for SK collet. ★Please add "C" at the Code No. for Centre Through Coolant type. e.g. S25-SK10C-250

★S19.5-SK6-200 is also available ★Please refer P.44 for adjust screw (G No.).



HIGH SPEED SLIM CHUCK

NIKKEN

MAX.40,000min⁻¹ & G2.5

Explanation of the Code No.

BT40 - SK 10 - 90 P

- Symbol of High Speed
- Nominal Gauge Length mm

- Chucking Capacity
- Symbol of Slim Chuck
- Shank No.



SK-P

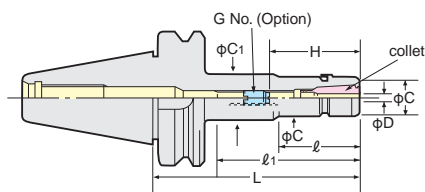


Fig. 1

When SK J type nut is used, the total chuck length will be extended by 6mm.

PAT.

TAPER	Code No.	D	L	ℓ	ℓ ₁	C	C ₁	H	G No. (Option)	MAX. (min ⁻¹)	collet	weight (kg)	
No.30	BT30-SK 6- 60P	0.7 ~ 6.0	60	33	33	19.5	19.5	21~35	SKG- 8	40,000	SK 6	0.7	
	- 90P		90	56	65		32					0.7	
	-120P		120	62	95		32					0.8	
	-SK10- 45P	1.75~10.0	45	22	22	27.5	27.5	30~50	SKG-12S		SK10	0.8	
	- 60P		60	35	35							0.9	
	- 75P		75	50	50							1.0	
	- 90P		90	65	65							1.0	
	-SK13- 60P	2.75~13.0	60	35	35	33	33	31~50	SKG-15		SK13	1.1	
	- 75P		75	50	50							1.1	
	- 90P		90	65	65							1.1	
	-SK16- 60P	2.75~16.0	60	37	37	40	40	45~60	SKG-12L		SK16	1.2	
	- 75P		75	52	52							1.2	
	- 90P		90	67	67							1.2	
	-SK20- 60P	3.5~20.0	60	37	37	48.5	48.5	65~70	SKG-18L		SK20	1.3	
	- 75P		75	52	52							0.7	
	- 90P		90	67	67							0.9	
-SK25- 90P	7.5~25.4	90	67	67	55	55	55~75	SKG-12	SK25	1.2	1.5		
No.40	BT40-SK 6- 60P	0.7 ~ 6.0	60	30	30	19.5	19.5	21~35	SKG- 8	30,000	SK 6	1.0	
	- 90P		90	51	60		32					1.1	
	-120P		120	60	90		25					1.4	
	-150P		150	60	120		25					1.5	
	-SK10- 60P	1.75~10.0	60	32	32	27.5	27.5	30~50	SKG-12L		SK10	1.1	
	- 75P		75	45	45							40	1.2
	- 90P		90	48	60							40	1.2
	-120P		120	73	90							34.5	1.4
	-150P		150	73	118							39	1.6
	-SK13- 60P	2.75~13.0	60	28	28	33	33	31~65	SKG-15		SK13	1.6	
	- 75P		75	43	43							40	1.2
	- 90P		90	58	58							40	1.3
	-120P		120	88	88							40	1.4
	-150P		150	88	118							40	1.6
	-SK16- 60P	2.75~16.0	60	32	32	40	40	50~65	SKG-18S		SK16	1.8	
	- 75P		75	43	43							40~67	1.3
	- 90P		90	58	58							40~70	1.4
	-120P		120	88	88							40~70	1.5
	-150P		150	118	118							40~70	1.7
	-SK20- 60P	3.5~20.0	60	32	32	48.5	48.5	47~60	SKG-18L		SK20	2.0	
	- 75P		75	45	45							47~70	1.3
	- 90P		90	60	60							47~80	1.4
	-120P		120	90	90							47~80	1.6
	-SK25- 75P	7.5~25.4	75	47	47	55	55	55~75	SKG-12		SK25	2.0	
- 90P	90		61	61	55~75					1.7			
-120P	120		91	91	55~85					1.8			

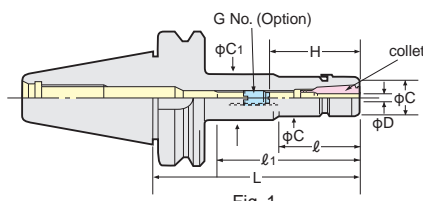
HIGH SPEED SLIM CHUCK



MAX.40,000min⁻¹ & G2.5



SK-P



Explanation of the Code No.

BT40 - SK 10 - 90 P

- Symbol of High Speed
- Nominal Gauge Length mm
- Chucking Capacity
- Symbol of Slim Chuck
- Shank No.

When SK J type nut is used, the total chuck length will be extended by 6mm.

PAT.

TAPER	Code No.	D	L	ℓ	ℓ ₁	C	C ₁	H	G No. (Option)	MAX. (min ⁻¹)	collet	weight (kg)
No.50	BT50-SK 6-105P	0.7 ~ 6.0	105	55	64	19.5	32	21~35	SKG- 8	20,000	SK 6	3.8
	-135P		135		92							3.9
	-165P		165	60	114							4.0
	-200P		200		151							4.2
	-SK10-105P	1.75~10.0	105	57	57	27.5	32	30~50	SKG-12L	20,000	SK10	4.2
	-135P		135	70	92							4.4
	-165P		165		114							4.6
	-200P		200	75	151							4.8
	-225P	225		178	5.0							
	-SK13-105P	2.75~13.0	105	62	62	33	33	31~65	SKG-15	20,000	SK13	4.5
	-135P		135		92							4.7
	-165P		165	92	122							4.9
	-200P		200		157							5.2
	-SK16-105P	2.75~16.0	105	62	62	40	40	40~70	SKG-18L	20,000	SK16	4.7
	-135P		135	92	92							4.9
	-165P		165	90	122							5.1
	-200P		200		157							5.5
	-SK20-105P	3.5~20.0	105	62	62	48.5	48.5	47~80	SKG-22	20,000	SK20	4.3
	-135P		135	92	92							4.6
	-165P		165	122	122							5.0
-200P	200		157	157	5.4							
-SK25-105P	7.5~25.4	105	62	62	55	55	50~85	SKG-28	15,000	SK25	5.2	
-135P		135	92	92							5.4	
-165P		165	122	122							5.6	
-200P		200	157	157							6.0	

★Collet, adjust screw (G No.) and GH Handle are available as an option.

The Code No. of the GH Handle is SK6-P: GH6, SK10-P: GH10, SK13-P: GH13, SK16-P: GH16, SK20-P: GH20, SK25-P: GH25

★Please refer P.43 for TIN Bearing Nut.

★Please refer P.43 for SK collet.

★Adjust screw with centre hole P.44 can be used for centre through tool coolant application (MAX. 1MPa).

Please refer P.44 for adjust screw (G No.).



GH Handle

Code No. for SLIM CHUCK with SPECIAL NUT



Code No. for Slim Chuck with special nut

Standard nut (for C-spanner) is attached for standard slim chuck.

Nut for high speed (for GH Handle) is attached for high speed slim chuck.

- Standard slim chuck + J type nut : Please add "-J" at the end of Code No. e.g. BT40-SK10-90-J
- Standard slim chuck + Nut for high speed : Please add "-G" at the end of Code No. e.g. BT40-SK10-90-G
- Standard slim chuck + J type nut for high speed : Please add "-GJ" at the end of Code No. e.g. BT40-SK10-90-GJ
- High speed slim chuck + J type nut : Please add "-J" at the end of Code No. e.g. BT40-SK10-90P-J

Code No. for VC holder with special nut

- With J type nut : Please add "-J" at the end of Code No. e.g. BT40-VC13-90-J

Code No. for MAJOR DREAM holder with special nut

- With J type nut : Please add "-J" at the end of Code No. e.g. BT40-MDSK13-90-J
- With nut for C-spanner : Please add "-SN" at the end of Code No. e.g. BT40-MDSK13-90-SN
- With J type nut for C-spanner : Please add "-SNJ" at the end of Code No. e.g. BT40-MDSK13-90-SNJ

When RPT treatment is required at same time, please add "-RP" first. e.g. BT40-SK10-90-RP-J

TiN BEARING NUT for SLIM CHUCK

NIKKEN

Nut of SK-P for GH handle and Nut of SKT/MDSK are same for SK10, SK13 and SK20.
Nut of SK-P for GH handle and Nut of SKT/MDSK are different for SK6, SK16 and SK25.

SK standard Nut (for C-Spanner)

standard	Style	TiN Bearing Nut	J type TiN Bearing Nut	C-Spanner
	SK 6(ϕ 19.5)	SKN- 6WB	SKN- 6WBJ	SKL- 6W
(Cap is option)	SK10	-10B	-10BJ	-10
	SK13	-13B	-13BJ	9HC12A
	SK16	-16B	-16BJ	9HC16
J type Nut	SK20	-20B	-20BJ	9HC22
	SK25	-25B	-25BJ	

SK-P Nut for High Speed (for GH Handle)

standard	Style	TiN Bearing Nut	J type TiN Bearing Nut	GH Handle
	SSK 6(ϕ 19.5)	SKN- 6WB(GH)	SKN- 6WBJ(GH)	GH 6
(Cap is option)	SK10	-10B(GH)	-10BJ(GH)	GH10
	SK13	MDSKN-13B	MDSKN-13BJ	GH12
	SK16	SKN-16B(GH)	SKN-16BJ(GH)	GH16
J type Nut	SK20	MDSKN-20B	MDSKN-20BJ	GH20
	SK25	SKN-25B(GH)	SKN-25BJ(GH)	GH25

SKT/MDSK Nut (for C-Spanner)

standard	Style	TiN Bearing Nut	J type TiN Bearing Nut	C-Spanner
	SKT 6 / MDSK 6	SKTN- 6B	SKTN- 6BJ	SKL- 6W
(Cap is option)	SKT10 / MDSK10	SKN -10B	SKN -10BJ	-10
	SKT13 / MDSK13	-13B	-13BJ	9HC12A
	SKT16 / MDSK16	SKTN-16B	SKTN-16BJ	9HC16
J type Nut	SKT20 / MDSK20	SKN -20B	SKN -20BJ	9HC22
	SKT25 / MDSK25	SKTN-25B	SKTN-25BJ	

SKT/MDSK Nut (for GH Handle)

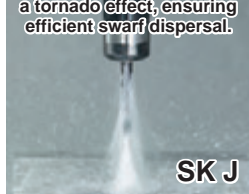
standard	Style	TiN Bearing Nut	J type TiN Bearing Nut	GH Handle
	SKT 6 / MDSK 6	MDSKN- 6B	MDSKN- 6BJ	GH 6
(Cap is option)	SKT10 / MDSK10	SKN -10B(GH)	SKN -10BJ(GH)	GH10
	SKT13 / MDSK13	MDSKN-13B	MDSKN-13BJ	GH12
	SKT16 / MDSK16	-16B	-16BJ	GH16
J type Nut	SKT20 / MDSK20	-20B	-20BJ	GH20
	SKT25 / MDSK25	-25B	-25BJ	GH25

To keep run-out accuracy high, you are recommended to change nuts periodically when slim chuck is used very frequently.

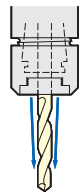
J TYPE NUT for SLIM CHUCK

NIKKEN

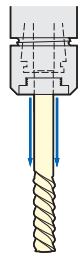
The Jet Coolant pressure creates a tornado effect, ensuring efficient swarf dispersal.



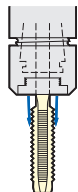
J type Nut



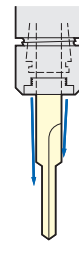
For standard drill.



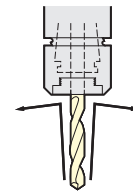
For reamer.



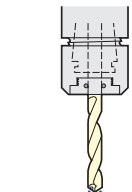
For tap.



For special cutter.

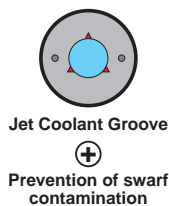
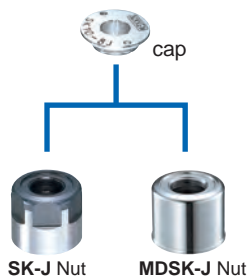


For prevention of swarf and dust contamination.



The cap with O-ring seal for using of oil hole drill is also available.

J type nut and cap fit all existing Slim Chuck.



Style	J type Nut Code No.		Cap Code No.	Wrench Code No.
	SK	SKT/MDSK		
SK 6(ϕ 18)	SKN- 6J*	-	SKJ 6-3, 3.3, 4, 4.2, 5, 6	SKJL- 6
SK 6(ϕ 19.5)	SKN- 6WBJ	MDSKN- 6BJ	SKJ10-3, 4, 5, 5.5, 6, 6.2, 6.8, 7, 8, 8.5, 10	SKJL-10
SK10	SKN-10BJ	SKN-10BJ(GH)	SKJ16-7, 8, 8.5, 10, 10.3, 12, 12.5, 14, 15, 16	SKJL-16
SK13	SKN-13BJ	MDSKN-13BJ	SKJ25-8, 10, 12, 16, 17.5, 20, 25	SKJL-25
SK16	SKN-16BJ	MDSKN-16BJ		
SK20	SKN-20BJ	MDSKN-20BJ		
SK25	SKN-25BJ	MDSKN-25BJ		

*When SK J type nut is used, the total chuck length will be extended to 6mm.

*SKN-6J maked * is not TiN Bearing Nut.

*The contamination of the swarf and the rust can be prevented even without coolant through application.

*The different ID hole is available as an option. Please contact us.

*The cap with O-ring at ID for oil hole drill is also available. e.g. SKJ10-4C

*When the ID hole will be machined at your side to buy a cap without hole, the centering of the cap is important. Please contact us.

HANDLE / SPANNER / WRENCH

NIKKEN

Handle for Milling Chuck

Style	Code No.
C12 (C ₁ = ϕ 30mm)	9HC12
C12 (C ₁ = ϕ 33mm)	9HC12A
C16	9HC16
C20	9HC22
C25 (C ₁ = ϕ 55mm)	9HC22
C25 (C ₁ = ϕ 60mm)	9HC25
C32 (C ₁ = ϕ 64mm)	9HC25
C32 (C ₁ = ϕ 69mm)	9HC32
C42	9HC42

Spanner for Slim Chuck

Style	Code No.
SK6 (C= ϕ 18mm)	SKL-6
SK6 (C= ϕ 19.5mm)	SKL-6W
SK10	SKL-10
SK13	9HC12A
SK16	9HC16
SK20	9HC22
SK25	9HC22

Wrench for NPU Drill Chuck

Style	Code No.
NPU 8	NPUL- 8
NPU13	NPUL-13

ADJUST SCREW for SLIM CHUCK



The adjust Screw for the High Speed Slim Chuck "GSK-P type" is identical to the Standard Slim Chuck as below.
e.g. The adjust Screw for BT30-GSK10-45P is SKG-12S, is the same as the screw for BT30-SK10-45.

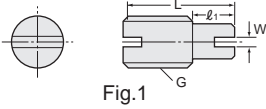


Fig.1

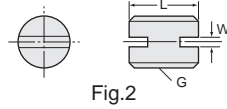


Fig.2

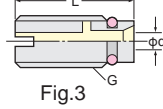


Fig.3

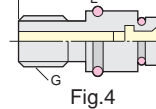


Fig.4

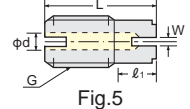


Fig.5

Please remove standard Adjust Screw or use the Adjust Screw specially designed to J type Nut for the stopper.

SK

Explanation of the Code No. of the Adjust screw for Standard Slim Chuck

e.g. **SKG** - **12** **L** - **J**

- None, -J : Symbol of adjust screw used with J type nut (Fig.5)
- None, S, L : Length indication
- 8, 12, 18, 28 : Screw size
- Symbol of adjust screw

Style	Adjust Screw Code No.	Fig.	Slim Chuck Code No.
SK 6	SKG- 8	1	All SK6 Slim Chucks
SK10	SKG-12L	1	All SK10 Slim Chucks except below
	SKG-12S	2	BT30-SK10-45, HSK50A-SK10-90, HSK63F-SK10-90
SK13	SKG-15	1	All SK13 Slim Chucks
SK16	SKG-18L	1	All SK16 Slim Chucks except below
	SKG-12	2	BT30-SK16-90
	SKG-12L	1	BT30-SK16-60
	SKG-18S	2	BT40-SK16-60
SK20	SKG-22	1	All SK20 Slim Chucks except below
	SKG-12	2	BT30-SK20-90
	SKG-12L	1	BT30-SK20-75
	SKG-12S	2	BT30-SK20-60
SK25	SKG-28	1	All SK25 Slim Chucks except below
	SKG-12	2	BT30-SK25-90, BT40-SK25-75
	SKG-12MF	2	NC5-46-SK25-90

★W=2mm is standard. W=2.4, 3, 4, 5, 6, 8, 12mm are also available. e.g. SKG-12L-W2.4
Please choose suitable one for the tang width of your drill.

Explanation of the Code No. of the Adjust screw with centre hole for Standard Slim Chuck

e.g. **SKG** - **12** **H** **A**

- None, A : Centre hole indication
- H : With centre hole
- 12, 18, 28 : Screw size
- Symbol of adjust screw

Style	Screw Size	Adjust Screw Code No.	Fig.	Hole Dia.	Cutter Shank Dia.	Wrench width
SK10	M12	SKG-12H	3	φ4	φ6~	3
		SKG-12HA		φ2.5	φ4~	2
SK13	M15 P1.0	SKG-15H		φ4	φ6~	3
		SKG-15HA		φ2.5	φ4~	2
SK16	M12	SKG-12H		φ4	φ6~	3
		SKG-12HA		φ2.5	φ4~	2
	M18 P1.5	SKG-18H		φ7.2	φ10~	6
		SKG-18HA		φ3.5	φ5~	3
SK20	M12	SKG-12H		φ4	φ6~	3
		SKG-12HA		φ2.5	φ4~	2
M22 P1.5	SKG-22H	φ8		φ10~	5	
	SK25	M12		SKG-12H	φ4	φ6~
SKG-12HA			φ2.5	φ4~	2	
M28 P2.0	SKG-28H	φ12	φ16~	8		

★The adjust screw for oil hole tap is also available. Please contact with us.
★These adjust screws are for the coolant pressure up to 1MPa.

SK-C There is no leakage of coolant from screw, because OD of the straight portion of the adjust screw is sealed.

Explanation of the Code No. of the Adjust screw for High Pressure Coolant Slim Chuck

e.g. **SKG** **10** - **10** **HG** **B** - **J**

- None, -J : Symbol of adjust screw used with J type nut (Fig.5)
- None, A, B, ... : Specification (Length, for small drill, for Tap...)
- Symbol of high pressure coolant
- 6, 10, 12, 18, 24 : Screw size
- 6, 10, 16, 25 : Slim chuck style
- Symbol of adjust screw

3LOCK tool (MBT, MIT and MCAT) , 2LOCK tool (NBT, NIT and NCAT) , NC5 tool and HSK tool can be used at high pressure centre through tool coolant application (MAX.7MPa) .

Please change the shank No. from BT to MBT or NBT for 3LOCK tool or 2LOCK tool.

The adjust screw for BT40-SK16F-90 is same as the adjust screw for MBT40-SK16F-90 and NBT40-SK16F-90.

Please refer adjust screw for oil hole holder.

SKO P.111, MOK P.109

Style	Adjust Screw Code No.	Fig.	Hole Dia.	Cutter Shank Dia.	Slim Chuck Code No.	Wrench width	
SK 6	SKG 6- 6HG	4	φ2.5	φ4~	All SK6C/SK6F Slim Chucks	2	
SK10	SKG10-10HG		φ4	φ6~	All SK10C/SK10F Slim Chucks	4	
	SKG10-10HGA		φ2.5	φ4~		2	
SK13	SKG13-10HG		φ4	φ6~	All SK13C/SK13F Slim Chucks	4	
	SKG13-10HGA		φ2.5	φ4~		2	
SK16	SKG16-12HG		6	φ7.2	φ10~	All SK16C/SK16F Slim Chucks except below	6
	SKG16-12HGB					BT40-SK16F-90	
	SKG16-10HG					HSK40A-SK16C-120, HSK50A-SK16C-120	
						HSK63A-SK16C-120, 150, HSK100A-SK16C-120	
						NC5-46-SK16C-90, -120, NBT40-SK16C-60, NBT30-SK16C-75	
						NBT30-SK16C-60	
SK16	SKG16-12HGE		3	φ3.5	φ5~	All SK16C/SK16F Slim Chucks except below	3
	SKG16-12HGA	BT40-SK16F-90					
	SKG16-12HGBA	HSK40A-SK16C-120, HSK50A-SK16C-120					
		HSK63A-SK16C-120, 150, HSK100A-SK16C-120					
		NC5-46-SK16C-90, -120, NBT40-SK16C-60, NBT30-SK16C-75					
		NBT30-SK16C-60					
SK20	SKG20-18HG	5	φ6.8	φ10~	All SK20C/SK20F Slim Chucks except below	5	
	SKG20-12MFHG				NC5-46-SK20C-90, NC5-53-SK20C-90, HSK63A-SK25C-135		
	SKG20-12HG				NC5-46-SK20C-120, NC5-53-SK20C-120, NBT30-SK20C-90		
					HSK100A-SK20C-150, -200		
					NBT30-SK20C-75		
					NBT40-SK20C-60		
SKG20-16HG	BT40-SK20F-90						
SK25	SKG25-24HG	8	φ12	φ16~	All SK25C/SK25F Slim Chucks except below	8	
	SKG25-24HGA				BT40-SK25F-120, BT50-SK25F-105		
	SKG25-18HGC				BT40-SK25F-90		
					BT40-SK25C-90, NC5-63-SK25C-135		
					NC5-85-SK25C-135, NBT40-SK25C-90		
					HSK63A-SK25C-135, HSK100A-SK25C-145, NBT40-SK25C-75		

★The adjust screw for oil hole tap is different from standard. The front end of the adjust screw is flat, not taper.

Please add "S" at the end of Code No. e.g. SKG10-10HGAS, SKG16-12HGAS, SKG16-12HGAS

★The adjust screw for extra small cutter shank dia. (φ3) is available. Please contact with us.

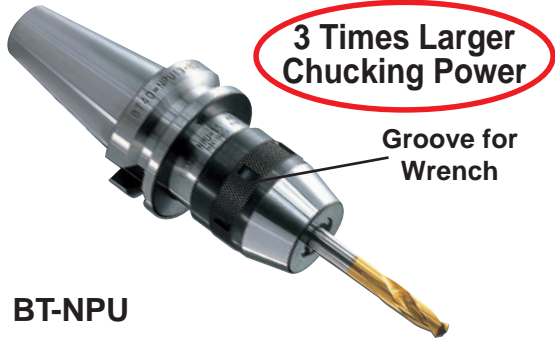
★The steel made adjust screw for SK10 or SK16 is available.

Please add "-FE" at the end of Code No. e.g. SKG10-10HG-FE



NC DRILL CHUCK

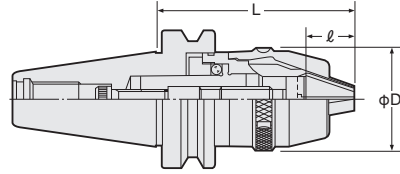
NIKKEN



BT-NPU

Being given favorable reception for its Compactness, High Precision & High Rigidity.

- The shank body fabricated solidly with the keyless drill chuck eliminates the possibility of slipping-off.
- The attached tightening wrench prevents slipping-off of drill to ensure the safety in unmanned operation.
- Chucking torque three times as large as ever before. There is no possibility of slipping-off of the carbide drill etc.



Chucking Length (l)
NPU 8 : 18.8mm
NPU13 : 26.5mm

PAT.

TAPER	Code No.	Chucking Dia	D	L		Weight (kg)
				MIN.	MAX.	
No.30	BT30-NPU 8- 70	0.3~8	38	76.5	83.5	0.7
	-NPU13- 95	1~13	48.5	102.1	113.1	1.2
No.40	BT40-NPU 8- 70	0.3~8	38	76.5	83.5	1.2
	(IT40) -110			115.5	122.5	1.5
	-155			160.5	167.5	1.7
	-NPU13- 80	1~13	48.5	86.1	97.1	1.5
	-130			137.1	148.1	2.2
	-175			182.1	193.1	2.7
No.50	BT50-NPU 8- 85	0.3~8	38	87.5	94.5	3.8
	(IT50) -110			115.5	122.5	3.9
	-170			175.5	182.5	4.3
	-NPU13- 90	1~13	48.5	97.1	108.1	4.1
	-130			137.1	148.1	4.6
	-190			197.1	208.1	5.2

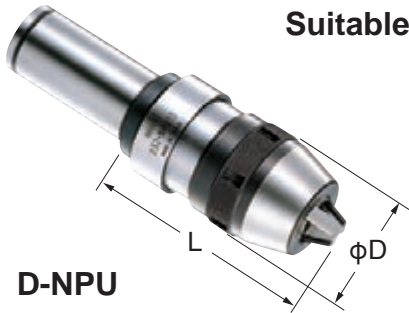
★Centre Through Type Drill Chuck has different L-length & Code No. ☞ P.106, Pull Stud with Oil Hole ☞ P.262.
 ★Flange Through Type Drill Chuck has different L-length & Code No. ☞ P.108.

★Wrench is available as an option. **NPU8**: NPUL-8, **NPU13**: NPUL-13.
 ★In case of IT40, **IT40-NPU8-80** is the shortest length.
 ★In case of IT50, **IT50-NPU8-80** is the shortest length.

Straight Shank NC DRILL CHUCK

NIKKEN

Suitable For MULTI-LOCK Milling Chuck



D-NPU

Style	Code No.	Chucking Dia	L		Weight (kg)
			MIN.	MAX.	
32	D32-NPU 8	0.3~8	65.5	72.5	0.9
	-NPU13	1~13	84.5	96.5	1.4
42	D42-NPU 8	0.3~8	55.5	62.5	1.2
	-NPU13	1~13	79.5	91.5	1.7

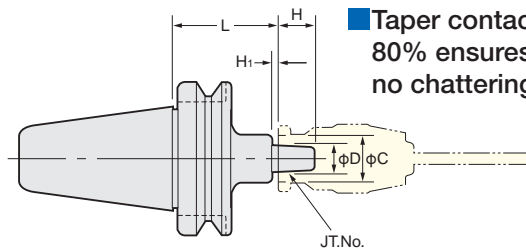
★φD : **NPU 8** : 36.5mm Chucking Length : **NPU 8** : 18.8mm ★Wrench is available as an option.
NPU13 : 48mm **NPU13** : 26.5mm **NPU8**: NPUL-8, **NPU13**: NPUL-13.

DRILL CHUCK ADAPTER

NIKKEN



JTA



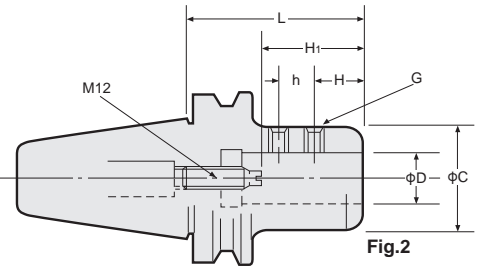
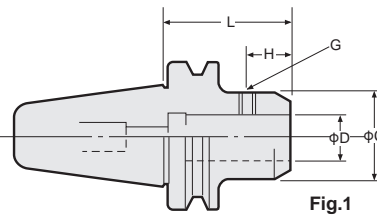
- Taper contact area of more than 80% ensures reliable drilling with no chattering accompanied.

TAPER	Code No. -L	JT. No.	D	H	H1	C	Weight (kg)
No.30	BT30-JTA6-30	6	17.17	24	4	30	1.0
No.40	BT40-JTA6-45, 90						1.1, 1.4
No.50	BT50-JTA6-45, 105						4.0, 4.4

★Each Drill chuck Adapter is supplied without drill chuck.

★For high speed and high accurate application, Slim Chuck ☞ P.37 is highly recommended.

SIDE LOCK HOLDER "A" TYPE (for END MILL)



SL,SLA

■ Taper contact area of more than 80% ensures reliable cutting with no chattering.

TAPER	Code No.	D	L	C	H	h	H ₁	G	fig	Weight (kg)
							MIN.~MAX.			
No.30	BT30-SL 6-60	6	60	20	15	—	—	M 6	1	1.2
	-SL 8-60	8		24	16			1.2		
	-SL 10-60	10		30	20			1.2		
	-SL 12-60	12		35	22.5			1.2		
	-SL 16-60	16	40	24	15	55~70	M14 P=1.5	2	1.3	
No.40	BT40-SL 6-65	6	65	20	15	—	—	M 6	1	1.6
	(IT40)-SL 8-65	8		24	16			1.6		
	-SL 10-65	10		30	20			1.6		
	-SL 12-65	12		35	23			1.6		
	-SL 16-65	16	40	24	21	55~70	M14 P=1.5	2	1.7	
	-SLA20-90	20	50	25	25	M16 P=1.5	1.9			
	-SLA25-90	25	60	25	25	M14 P=1.5	1	4.3		
	-SLA32-90	32	60	25	25	M8		4.3		
No.50	BT50-SL 6-75	6	75	20	15	—	—	M 6	1	4.3
	(IT50)-SL 8-75	8		24	16			4.3		
	-SL 10-75	10		30	20			4.3		
	-SL 12-75	12		35	23			4.5		
	-SL 16-75	16	40	24	21	55~70	M14 P=1.5	2	4.8	
	-SLA20-105	20	50	25	25	M16 P=1.5	4.7			
	-SLA25-105	25	60	25	25	65~80	M16 P=1.5	2	4.9	
-SLA32-105	32	60	25	25	85~100	M20 P=2.0	6.6			
-SLA42-115	42	90	30	32						

★Code No. of Side Lock Holder for Combination Shank is DM.
★The Code No. of Centre Through Coolant type is "SLOC". ☎P.106

BT50-DM32 -120
-DM50.8-120



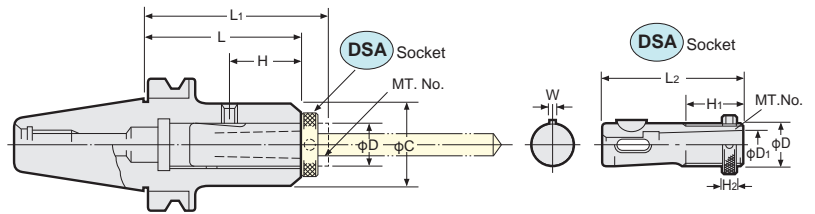
SIDE LOCK HOLDER "B" TYPE (for DRILL)



SLB



■ Taper contact area of more than 80% ensures reliable drilling with no chattering.



TAPER	Code No.	D	L	L ₁	H	C	W	DSA Socket-MT.No.	Weight (kg)
				MIN.~MAX.					
No.30	BT30-SLB26-105	26	105	117~142	40	50	5	DSA26-MT1,MT2	1.5
									1.4
No.40	BT40-SLB26-105	26	105	117~142	40	50	5	DSA26-MT1,MT2	2.1
									2.0
	-SLB35-135	35	135	147~182	55	60	6	DSA35-MT2,MT3	3.3
									3.2
No.50	BT50-SLB26-105	26	105	117~142	40	50	5	DSA26-MT1,MT2	4.8
									4.7
	-SLB35-120	35	120	132~167	55	60	6	DSA35-MT2,MT3	5.4
									5.3
	-SLB35-135	35	135	147~182	55	60	6	DSA35-MT2,MT3	5.7
5.6									
-SLB48-165	48	165	181~227	65	80	8	DSA48-MT3,MT4	8.4	
									8.1

MORSE TAPER ADAPTER A TYPE

NIKKEN

BT



MTA

■ Taper contact area of more than 80% ensures high repeatability run-out accuracy.

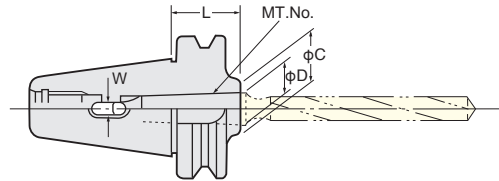


Fig. 1

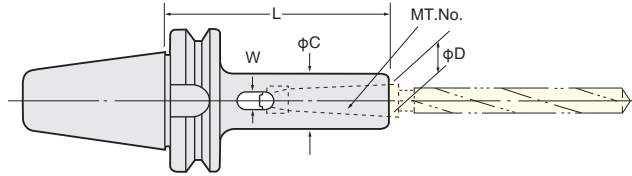


Fig. 2

TAPER	Code No.	MT. No.	D	L	C	W	Fig	Weight (kg)
No.30	BT30-MTA1- 45	1	12.065	45	20	5.6	1	0.8
	-MTA1-105			105			2	0.9
	-MTA2- 60	2	17.780	60	30	6.6	1	0.9
	-MTA2-120			120			2	1.2
	-MTA3- 80	3	23.825	80	40	8.4	1	1.0
No.40	BT40-MTA1- 45	1	12.065	45	25	5.6	1	1.0
	(IT40)-MTA1-120			120			2	1.3
	-MTA2- 60	2	17.780	60	32	6.6	1	1.1
	-MTA2-120			120			2	1.4
	-MTA3- 75	3	23.825	75	40	8.4	1	1.2
	-MTA3-135			135			2	1.8
	-MTA4- 95	4	31.267	95	50	12.4	1	1.4
	-MTA4-165			165			2	2.4
No.50	BT50-MTA1- 45	1	12.065	45	25	5.6	1	4.0
	(IT50)-MTA1-120			120			2	4.3
	-MTA1-180			180			2	4.3
	-MTA2- 45	2	17.780	45	32	6.6	1	4.0
	-MTA2-135			135			2	4.4
	-MTA2-180			180			2	4.6
	-MTA3- 45	3	23.825	45	40	8.4	1	3.9
	-MTA3-150			150			2	4.7
	-MTA3-180			180			2	4.9
	-MTA4- 75	4	31.267	75	50	12.4	1	4.0
	-MTA4-180			180			2	5.4
	-MTA5-105			105			5	44.399

★Centre through type MT Adapter has different dimensions.

★Flange through type MT Adapter has different dimensions.

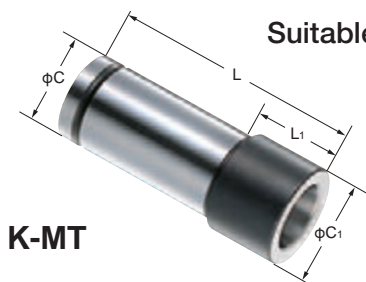


For high pressure coolant through, please use Milling Chuck P.29, Slim Chuck P.37 or Side Lock Holder P.46 instead of MT Adapter.

Straight Shank MORSE TAPER SOCKET

NIKKEN

Suitable for MULTI-LOCK Milling Chuck



K-MT

Style	Code No.	L	L1	C	C1
20	K20-MT1, MT2	59, 70.5	5, 20	20	25
25	K25-MT1, MT2	59, 70.5	3, 10.5	25	29
32	K32-MT1, MT2, MT3	59, 70.5, 88	3, 8.5, 26	32	37
42	K42-MT1, MT2, MT3, MT4	59, 70.5, 89, 113.5	5, 5, 5, 18	42	48

MORSE TAPER ADAPTER B TYPE with DRAW BOLT



MTB

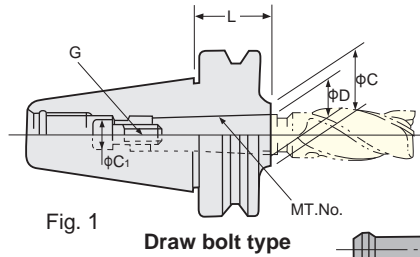


Fig. 1

Draw bolt type

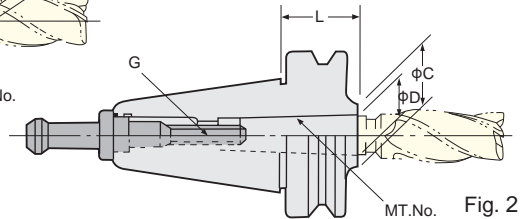


Fig. 2

Pull stud draw bolt type.

■ Taper contact area of more than 80% ensures reliable machining without vibration.

TAPER	Code No.	MT.No.	D	L	C	C ₁	G	Fig	Weight (kg)	
No.30	BT30-MTB1- 45	1	12.065	45	25	10	M 6×1	1	0.8	
	-MTB2- 25	2	17.780	25	32	—	M10×1.5	2	0.8	
	-MTB3- 80	3	23.825	80	40	—	M12×1.75		1.0	
No.40	BT40-MTB1- 45	1	12.065	45	25	10	M 6×1	1	1.0	
	-MTB2- 60	2	17.780	60	32	13.5	M10×1.5		1.1	
	-MTB3- 45	3	23.825	45	40	—	M12×1.75	2	1.1	
	-MTB4- 85	4	31.267	85	50	—	M16×2		1.3	
No.50	BT50-MTB1- 45	1	12.065	45	25	10	M 6×1	1	3.9	
	-MTB2- 45	2	17.780		32	16	M10×1.5		3.9	
	-MTB3- 60	3	23.825	60	40	18	M12×1.75		3.9	
	-MTB4- 75	4	31.267	75	50	20.5	M16×2		3.9	
	-MTB5-105-M16	5	44.399	105	70	—	—		2	4.2
	-MTB5-105									4.0

★Adapter in Fig.1 is supplied with a special draw bolt.

★Morse Taper Adapters B type as illustrated in Fig.2 need the special pull stud. The pull stud is optional accessory. When ordering, please specify the pull stud code number.

PULL STUD for MORSE TAPER ADAPTER B TYPE



MT No.	DRAW BOLT
MT 2	M10×1.5
MT 3	M12×1.75
MT4 / MT5	M16×2
MT 5	M20×2.5

TAPER	Standard pull stud Code No.	MTB2	MTB3	MTB4	MTB5
No.30	PS- 16	PS-27	PS- 32	—	—
	- 17	-28	- 33	—	—
No.40	PS- 1	—	PS- 7	PS- 8	—
	- 2	—	- 29	- 10	—
	- 08-1	—	- 017	- 018	—
	- P5-1	—	- P51	- P52	—
	- G51	—	- G56	- G57	—
	- 805	—	- 872	- 873	—
No.50	PS- 5	—	—	PS- 57	PS-15*
	- 6	—	—	- 65	-61*
	- 0	—	—	- 016	-06*

★For standard pull stud Code No. Please refer to P.261.

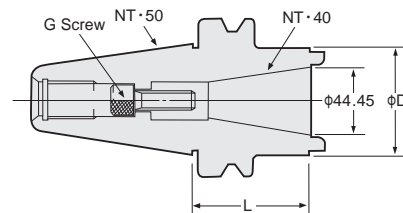
★The screw of the pull stud marked * is M20.

★The other type of pull stud is available, please specify the pull stud Code No.

SLEEVE for NT40 TOOL



TSA



Code No.	L	D	G	Weight (Kg)
BT50-TSA40M-75	75	70	M16P=2	4.6
(IT50)-TSA40U-75			5/8-11UNC	4.6

★G Screw is standard accessory. When ordering, please specify M (metric) or U (inch).

★Above Code No. is the sleeve which internal taper is for conventional T40U (M). When internal taper is BT40, G screw 9TSA40-M16-70L (option) is necessary.

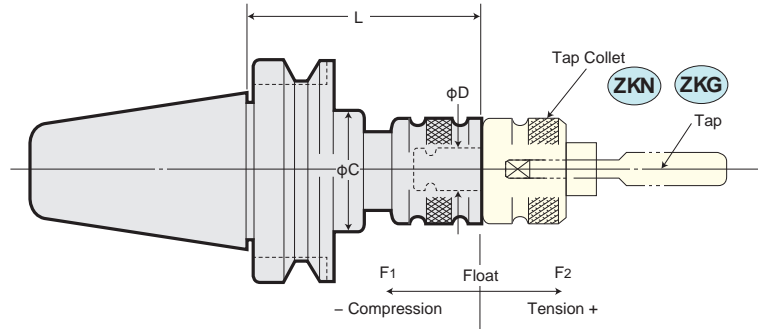
AUTO. DEPTH CONTROL TAPPER CHUCK

NIKKEN

- Most suitable for tapping gas threads, blind-end threads and light alloys.
- When normal rotation of machine is stopped at specified position, the Tapper Chuck runs idle after progressing by its elongation (4mm for ZL12 type). Simply rotate the machine in the reverse direction, and the tap depth will be made uniform within a high-precision.

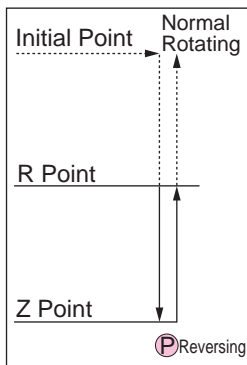


ZL



TAPER	Code No.	Tapping Capability			D	L	C	Float		Tap Collet	Weight (kg)
		M	U	P				F ₁	F ₂		
No.30	BT30-ZL 8-110*1	M 2~8	1/8~1/4	—	13	110	34	3	3	ZKN 8*1	1.5
	-ZL12-130	M 2~12	1/8~1/2	P1/16~1/4	19	130	58	5	4	ZKG12	1.9
No.40	BT40-ZL 8-120*1	M 2~8	1/8~1/4	—	13	120	34	3	3	ZKN 8*1	1.6
	(IT40)-ZL12-100	M 2~12	1/8~1/2	P1/16~1/4	19	100	58	5	4	ZKG12	1.9
	-ZL12-130					130					2.3
	-ZL16-150	M 3~16	1/8~5/8	P1/8~3/8	25	150	60	6	7	ZKG16	2.9
	-ZL24-160	M 8~24	1/2~1	P1/4~5/8	30	160	73			ZKG24	3.3
	-ZL38-190	M18~38	3/4~13/8	P3/8~1	45	190	92	8	10	ZKN38	6.0
No.50	BT50-ZL 8-130*1	M 2~8	1/8~1/4	—	13	130	34	3	3	ZKN 8*1	4.2
	(IT50)-ZL12-85	M 2~12	1/8~1/2	P1/16~1/4	19	85	58	5	4	ZKG12	3.4
	-ZL12-130					130					4.3
	-ZL16-135	M 3~16	1/8~5/8	P1/8~3/8	25	135	60	6	7	ZKG16	4.6
	-ZL24-100	M 8~24	1/2~1	P1/4~5/8	30	100	73			ZKG24	4.5
	-ZL24-142					142		5.8			
	-ZL38-150	M18~38	3/4~13/8	P3/8~1	45	150	92	8	10	ZKN38	6.9

★In Case of IT40, IT40-ZL16-160 and IT40-ZL24-175 are standard.
 ★In Case of IT50, IT50-ZL12-130, IT50-ZL24-142 and IT50-ZL38-180 are standard.
 ★Marked *1 ZL8 Tapper Chuck and ZK8 Tap Collet are available as semi-standard.
 ★Please refer P.51 (ZKG) ~P.52 (ZK) for ISO, IMPERIAL, DIN Tap Collet, P.53 (ZKG) ~P.54 (ZKN) for JIS Tap Collet, and P.55 for Long Size Tap Collet.
 ★Centre Coolant type Tapper Chuck is also available. Please contact with us.
 ★Flange through type Tapper Chuck is also available. Please contact with us.



Program of Auto-Depth Control Tapper Chuck

(ZL)

- NO. 1 M03 S—; Spindle Rotating
- NO. 2 G00 X—Y—; Initial Point
- NO. 3 G00 Z—; R Point
- NO. 4 G01 Z—F—; Z Point
- NO. 5 G04 P—; Dwell
- NO. 6 M05 Spindle Stop
- NO. 7 M04 Spindle Reversing
- NO. 8 G01 Z—; R Point
- NO. 9 M05 Spindle Stop
- NO.10 G00 Z— M03; Initial Point, Spindle Normal Rotating

⚠ When using ZL Tapper Chuck, please make sure of the following program.

G04 P —; — Threads are made only by Spindle Rotation during Dwell. Thus, exact depth is controlled.

M05 ; — Spindle stop.

M04 ; — First command Spindle Reversing. Then, upward movement of Z. If upward movement of Z is commanded earlier than Spindle Reversing, down movement of tap and up movement of Z may cause breakage of tap.

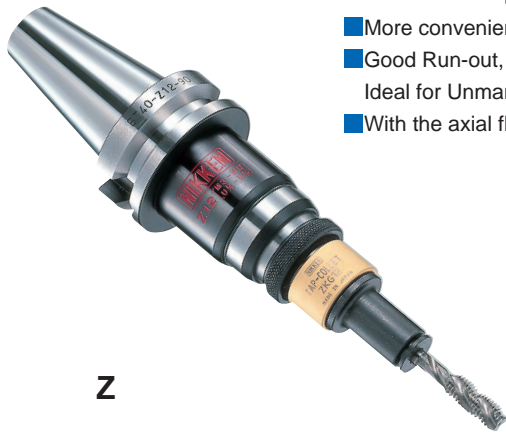
G01 Z —; —

FLOATING TAPPER CHUCK

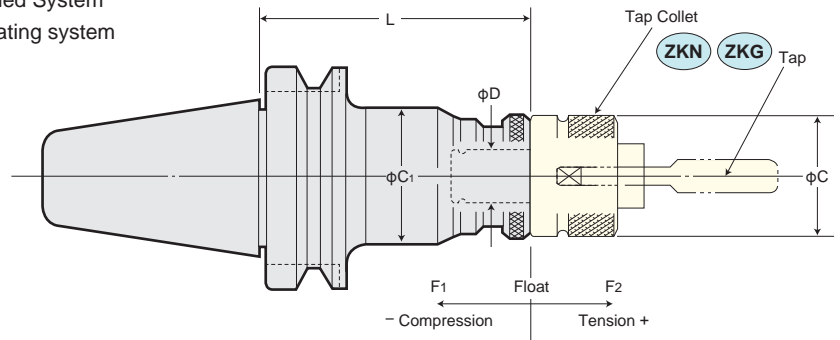


Suitable Tapper Chuck for Conventional M/C

- More convenient in tapping, thanks to stable torque and slim body
- Good Run-out, No Pull-out and No Tap Breakage with NIKKEN Tapper Chuck
Ideal for Unmanned System
- With the axial floating system



Z



TAPER	Code No.	Tapping Capability			D	L	C	C ₁	Float		Tap Collet	Weight (kg)	
		M	U	P					F ₁	F ₂			
No.30	BT30-Z 8- 90* ¹	M 2~ 8	1/8~1/4	—	13	90	23	33	5	15	ZKN 8* ¹	1.2	
	-Z12-105	M 2~ 12	1/8~1/2	P1/16~1/4	19	105	32	45	5	15	ZKG12	1.2	
No.40	BT40-Z 8- 90* ¹	M 2~ 8	1/8~1/4	—	13	90	23	33	5	15	ZKN 8* ¹	1.4	
	(IT40)-Z12- 90	M 2~ 12	1/8~1/2	P1/16~1/4	19	90	32	45	5	15	ZKG12	1.5	
	-Z12-130								15			1.6	
	-Z16-109	M 3~ 16	1/8~5/8	P1/8~3/8	25	109	39	55	8	20	ZKG16	2.0	
	-Z24-100	M 8~ 24	1/2~ 1	P1/4~5/8	30	100	46	68	10	20	ZKG24	2.1	
	-Z24-187											63	20
-Z38-140	M18~ 38	3/4~13/8	P3/8~ 1	45	140	78	85	8	22	ZKN38	6.7		
No.50	BT50-Z 8-105* ¹	M 2~ 8	1/8~1/4	—	13	105	23	33	5	15	ZKN 8* ¹	4.2	
	(IT50)-Z12-130	M 2~ 12	1/8~1/2	P1/16~1/4	19	130	32	45	15	15	ZKG12	4.3	
	-Z12-175											175	4.8
	-Z12-220											220	5.0
	-Z16-135	M 3~ 16	1/8~5/8	P1/8~3/8	25	135	39	55	8	20	ZKG16	5.2	
	-Z24-142	M 8~ 24	1/2~ 1	P1/4~5/8	30	142	46	63	20	20	ZKG24	5.8	
	-Z24-187											187	6.2
	-Z38-175	M18~ 38	3/4~13/8	P3/8~ 1	45	175	78	98	10	25	ZKN38	8.3	
-Z65-160	M36~100	1~33/4	P1~ 3	68	160	110* ² (125)	110	10	25	ZKN65	9.0		

★In Case of IT40, IT40-Z8-95*¹ and IT40-Z24-125 are standard.

★In Case of IT50, IT50-Z8-105*¹, IT50-Z38-187 and IT50-Z65-165 are standard.

★Marked *1 Z8 Tapper Chuck and ZK8 Tap Collet are available as semi-standard.

★Please refer to P.51 (ZKG) ~ P.52 (ZK) for ISO, IMPERIAL, DIN Tap Collet, P.53 (ZKG) ~ P.54 (ZKN) for JIS Tap Collet, and P.55 for Long Size Tap Collet.

★Marked *2 () dimension is for M65 or more size of ZK Tap Collet.



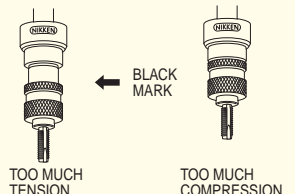
① Caution for Floating Mechanism

(1). Too Much Tension

When tension movement exceeds the limitation, the black line will appear. In this case increase machine feed.

(2). Too Much Compression

When machine feed is too fast for the tap thread pitch, the compression floating mechanism will work. The machine program should be modified to slow feed rate down.



② When the drilled hole diameter is too small (this is often caused by the drilling of the tough materials, extended drilling diameter is not large enough.), the tap will slip before the breakage due to torque limiter mechanism. In this case enlarge the drilled hole and do not adjust the torque setting.

③ For a blind hole tapping, the tap might hit the bottom of the hole and the floating shaft will not extend any further, if the Z point is too close to the component. And the point of reversing the floating shaft could compress further than the extension, it may cause damage to the tapped hole. In this case, make the drilled hole deeper or restrict Z point at the higher position.

④ When the R point is too close to the component, the spindle will moves upwards with the fully extended float mechanism at reversing operation, and it might cause damage to the tapped hole as the tap may be still in the hole when the spindle try to return to the initial point at the rapid feed. In this case, give further distance between the R point and the component.

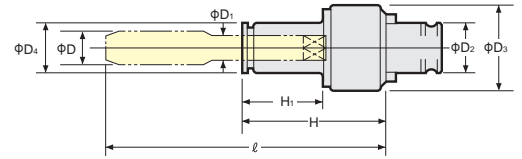
⑤ In case of the tapping with Z type tapper chuck, since the Z Axis stroke will move upwards after reversing operation starts at the Z point due to the machine tapping cycle features, it may cause damage to the tapped hole. In this case, input the dwell command at the Z point on the program in order to make the upward movement of Z Axis with the taper chuck as its extended float mechanism.

ONE TOUCH TAP COLLET (ISO, IMPERIAL, DIN)



- Can be used with all NIKKEN Floating Tapper Chucks.
- Setting and Removal of Tap can be done in ONE TOUCH.
- Torque Limiter Mechanism built-in.

Reversing Torque is 1.4 times of Normal Rotation in order to prevent the troubles caused by swarf.



ZKG

Tapping Capacity	ZKG12		ZKG16			ZKG24		
	M2~5	M6~12	M3~5	M6~12	M14~20	M8~12	M14~20	M22~24
D ₂	19		25			30		
D ₃	32		39			46		
D ₄	13	19	13	19	26	19	26	32
H	54.5	55	64.5	65	66	73	74	
H ₁	30.5	31	37.5	38	42	45	48	

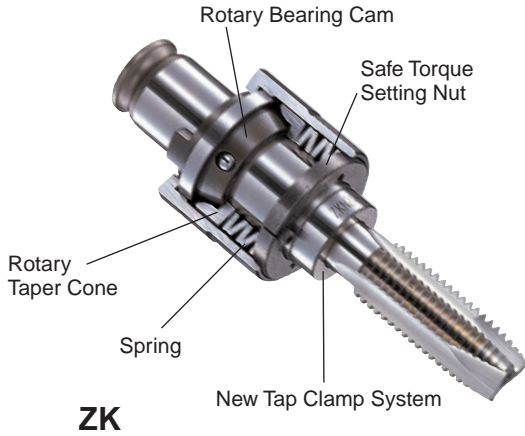
TAP SPEC.	ZKG12				
	Code No.	D	D ₁	W	ℓ
ISO Metric	ZKG12-2S	2	2.5	2	74
	-3S	3	3.15	2.5	79
	-4S	4	4	3.15	83
	-5S	5	5	4	87
	-6S	6	6.3	5	92
	-8S	8	8	6.3	96
	-10S	10	10	8	103
	-12S	12	9	7.1	111
ISO Pipe	ZKG12-1/8PS	9.728	8	6.3	87
IMPERIAL BSW BSF	ZKG12-1/8S(No.5S)	3.175	3.15	2.5	78
	-No.6S	3.505	3.55	2.8	80
	-No.8S	4.166	4.5	3.55	82
	-3/16S(No.10S)	4.762	5	4	86
	-No.12S	5.48	5.6	4.5	90
	-1/4S	6.35	6.3	5	90
	-5/16S	7.937	8	6.3	95
	-3/8S	9.525	10	8	101
	-7/16S	11.112	8	6.3	108
	-1/2S	12.7	9	7.1	111
IMPERIAL Pipe	ZKG12-1/8PB	9.728	8.08	6	83.037
DIN Metric	ZKG12-2D(DIN352)	2	2.8	2.1	72
	-3D(DIN371)	3	3.5	2.7	85
	-4D(DIN371)	4	4.5	3.4	92
	-5D(DIN371)	5	6	4.9	97
	-6D(DIN371)	6	6	4.9	107
	-8D(DIN376)	8	6	4.9	117
	-8D7(DIN371)	8	8	6.2	113
	-10D(DIN376)	10	7	5.5	124
	-10D7(DIN371)	10	10	8	121
	-12D(DIN376)	12	9	7	132
	DIN Pipe	ZKG12-1/8R(DIN353)	9.728	7	5.5
ZKG16					
	Code No.	D	D ₁	W	ℓ
ZKG16-4S	ZKG16-4S	4	4	3.15	93
	-5S	5	5	4	97
	-6S	6	6.3	5	102
	-8S	8	8	6.3	106
	-10S	10	10	8	113
	-12S	12	9	7.1	121
	-14S	14	11.2	9	122
	-16S	16	12.5	10	128
	ZKG16-1/8PS	9.728	8	6.3	97.5
	-1/4PS	13.157	10	8	103.5
	-3/8PS	16.662	12.5	10	109.5
	ZKG16-1/8S(No.5S)	3.175	3.15	2.5	88
	-No.6S	3.505	3.55	2.8	90
	-No.8S	4.166	4.5	3.55	92
	-3/16S(No.10S)	4.762	5	4	96
	-No.12S	5.48	5.6	4.5	100
-1/4S	6.35	6.3	5	100	
-5/16S	7.937	8	6.3	105	
-3/8S	9.525	10	8	111	
-7/16S	11.112	8	6.3	118	
-1/2S	12.7	9	7.1	121	
-9/16S	14.288	11.2	9	122	
-5/8S	15.875	12.5	10	128	
ZKG16-1/8PB	9.728	8.08	6	93.537	
-1/4PB	13.157	10.9	8.18	98.3	
-3/8PB	16.662	13.77	10.31	99.888	
ZKG16-4D(DIN371)	4	4.5	3.4	102	
-5D(DIN371)	5	6	4.9	107	
-6D(DIN371)	6	6	4.9	117	
-8D(DIN376)	8	6	4.9	127	
-8D7(DIN371)	8	8	6.2	123	
-10D(DIN376)	10	7	5.5	134	
-10D7(DIN371)	10	10	8	131	
-12D(DIN376)	12	9	7	142	
-14D(DIN376)	14	11	9	137	
-16D(DIN376)	16	12	9	137	
ZKG16-1/8R(DIN353)	9.728	7	5.5	102.5	
-1/4R(DIN353)	13.157	11	9	98.5	
-3/8R(DIN353)	16.662	12	9	105.5	
ZKG24					
Code No.	D	D ₁	W	ℓ	
ZKG24-12S	12	9	7.1	129	
-14S	14	11.2	9	130	
-16S	16	12.5	10	136	
-18S	18	14	11.2	145	
-20S	20	14	11.2	145	
-22S	22	16	12.5	145	
-24S	24	18	14	155	
ZKG24-1/4PS	13.157	10	8	110	
3/8PS	16.662	12.5	10	116	
-1/2PS	20.955	16	12.5	122	
-5/8PS	22.911	18	14	124	
ZKG24-1/2S	12.7	9	7.1	129	
-9/16S	14.288	11.2	9	130	
-5/8S	15.875	12.5	10	136	
-3/4S	19.05	14	11.2	145	
-7/8S	22.225	16	12.5	145	
-1S	25.4	18	14	155	
ZKG24-1/4PB	13.157	10.9	8.18	104.8	
-3/8PB	16.662	13.77	10.31	106.388	
-1/2PB	20.955	17.45	13.08	114.5	
-5/8PB	22.911	20.32	15.3	114.5	
ZKG24-12D(DIN376)	12	9	7	150	
-14D(DIN376)	14	11	9	145	
-16D(DIN376)	16	12	9	145	
-18D(DIN376)	18	14	11	158	
-20D(DIN376)	20	16	12	168	
-22D(DIN376)	22	18	14.5	166	
-24D(DIN376)	24	18	14.5	186	
ZKG24-1/4R(DIN353)	13.157	11	9	105	
-3/8R(DIN353)	16.662	12	9	112	
-1/2R(DIN353)	20.955	16	12	116	

★Long size TAP Collet is available. P55 e.g. ZKG12-4S-50L

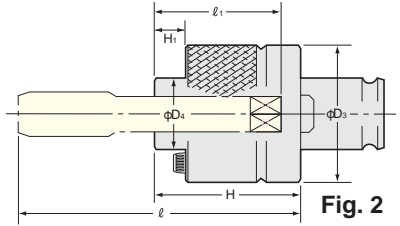
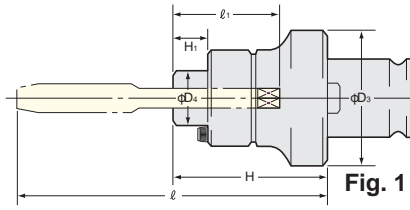
★TAP Clamp Mechanism for PIPE TAP is Side Lock System.

★High torque setting type example for stainless steel is available. Please add "HT" at the end of Code No. e.g. ZKG12-3S-HT

ZK TAP COLLET (ISO, IMPERIAL, DIN)



- Can be used with all NIKKEN Floating Tapper Chucks.
- Torque Limiter Mechanism built-in.



Total length "l" is calculated as ;
 $l = \text{Tap length} - l_1 + H$

	ZK8	ZK38	ZK65
D ₄	13	45	68
D ₃	23	78	110
H ₁	6.5	12	13
H	29.5	64	89

ZK8 type is semi-standard.

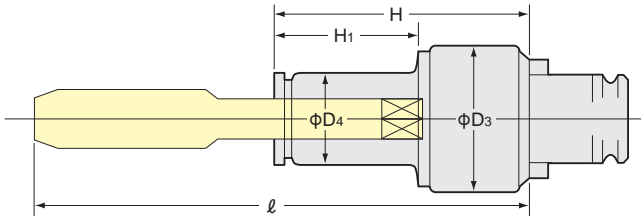
TAP SPEC.	ZK 8					Fig	ZK38					Fig	ZK65					Fig
	Code No.	D	D ₁	W	l ₁		Code No.	D	D ₁	W	l ₁		Code No.	D	D ₁	W	l ₁	
ISO Metric	ZK8-2S	2	2.5	2.0	22.5	2	ZK38-18S	18	14	11.2	44	1	ZK65-36S	36	25.0	20.0	58	
	-3S	3	3.15	2.5	23.5		-20S	20					-39S	39	28.0	22.4	60	
	-4S	4	4.0	3.15	24.5		-22S	22	16	12.5	46		-42S	42				
	-5S	5	5.0	4.0	25.5		-24S	24	18	14	48		-45S	45	31.5	25.0	65	
	-6S	6	6.3	5.0	26.5		-27S	27	20	16	54		-48S	48				
								-30S	30					-52S	52	35.5	28.0	68
IMPERIAL BSW BSF	ZK8-No.2S	2.18	2.8	2.24	23.5	2	ZK38-3/8PS	16.662	12.5	10	34	1	ZK65-11/4PS	41.910	31.5	25	51	
	-No.3S	2.515								-1/2PS	20.955		16	12.5	38	-11/2PS	47.803	35.5
	-No.4S	2.845	3.15	2.5	23.5		-3/4PS	22.911	18	14	40		-13/4PS	53.746				
	-No.5S(1/8S)	3.175								-7/8PS	26.441		20	16	46	- 2 PS	59.614	40
	-No.6S	3.505	3.55	2.8			- 1 PS	30.201	22.4	18	48							
	-No.8S	4.166	4.5	3.55	24.5		ZK38- 3/4S	19.050	14	11.2	44		ZK65-11/2S	38.100	28	22.4	60	
	-No.10S(3/16S)	4.826	5.0	4.0	25.5		- 7/8S	22.225	16	12.5	46		-13/4S	44.450	31.5	25.0	65	
	-No.12S	5.480	5.6	4.5			- 1 S	25.400	18	14	48		- 2 S	50.800	35.5	28.0	68	
	-1/4S	6.350	6.3	5.0	26.5		-11/8S	28.575	20	16	54		-21/4S	57.150	40.0	31.5	71	
							-11/4S	31.750	22.4	18	56		-21/2S	63.500				
					-13/8S	34.925	25	20	58									
IMPERIAL Pipe						2	ZK38- 3/8PB	16.662	13.77	10.31	33.7	1	ZK65-11/4PB	41.910	33.32	25.0	51	
							- 1/2PB	20.955	17.45	13.08	39.9		-11/2PB	47.803	38.10	28.57	50	
							- 5/8PB	22.911	20.32	15.3	39.5		-13/4PB	53.746	41.28	30.94	62	
							- 3/4PB	26.441	23.01	17.3	43.5		- 2 PB	59.614	47.63	35.71	56	
							- 7/8PB	30.201	27.76	20.6	45.1							
							- 1 PB	33.249	28.57	21.4	46.6							
DIN Metric	ZK8-2D	2(Din 371)	2.8	2.1	23.5	2	ZK38-18D	18(Din 376)	14	11	44	1	ZK65-36D	36(Din 376)	28.0	22.0	59	
	-3D	3(Din 371)	3.5	2.7	24.5		-20D	20(Din 376)	16	12	45		-39D	39(Din 376)	32.0	24.0	61	
	-4D	4(Din 371)	4.5	3.4			-22D	22(Din 376)	18	14.5	47		-42D	42(Din 376)				
	-5D	5(Din 371)	6.0	4.9	26.5		-24D	24(Din 376)					-45D	45(Din 376)	36.0	29.0	69	
	-6D	6(Din 371)								-27D	27(Din 376)		20	16	53	-48D	48(Din 376)	
	-8D	8(Din 376)					-30D	30(Din 376)	22	18	55		-52D	52(Din 376)	40.0	32.0	72	
							-33D	33(Din 376)	25	20	57		-56D	56(Din 376)	45.0	35.0	75	
							-36D	36(Din 376)	28	22	59		-60D	60(Din 376)				
													-64D	64(Din 376)	50.0	39.0	78	
	DIN Pipe							2	ZK38-3/8R	16.662	12		9	33	1	ZK65-11/8R	37.898 (Din 353)	28.0
						-1/2R	20.955		16	12	37	-11/4R	41.910 (Din 353)	32.0		24.0	53	
						-5/8R	22.911		18	14.5	39	-13/8R	44.325 (Din 353)	36.0		29.0	55	
						-3/4R	26.441		20	16	45	-11/2R	47.803 (Din 353)					
						-7/8R	30.201		22	18	47	-13/4R	53.746 (Din 353)					
						- 1 R	33.249		25	20	49	- 2 R	59.614 (Din 353)					

★ Tap collet Code No. "ZK" is for ISO, IMPERIAL and DIN Taps.
 ★ Tap collet Code No. "ZKN" is for JIS Taps.

ONE TOUCH TAP COLLET (JIS)

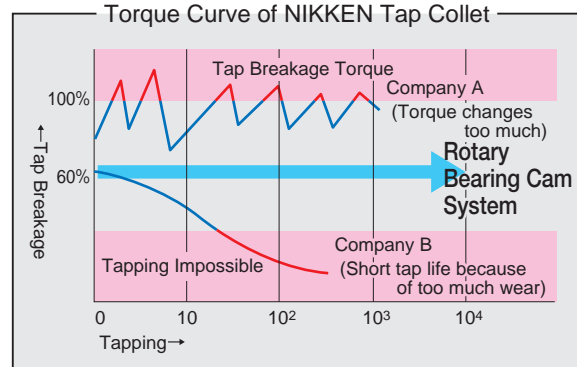


ZKG Tap Collet



D₃ Dimension
ZKG12:32mm
ZKG16:39mm
ZKG24:46mm

- **High Accuracy, Quick Response and Long Tap Life.**
 NIKKEN **ZKG** Tap Collet can be used with all of NIKKEN floating Tapper Chucks.
- **Rotary Bearing Cam Mechanism**
 The **ZKG** tap collet can respond very smoothly for the change of the tapping torque.



- The torque of CCW is 1.4 times of the torque of CW to prevent the problem of the swarf.
- The tap can be clamped with one touch operation.
- The adjustment mechanism of the setting torque is not installed on the ZKG tap collet. The high torque setting type is available for the tapping on the stainless as an option. e.g **ZKG12-4HT**

The **ZKG** tap collet is not interchangeable with **ZKN** tap collet.

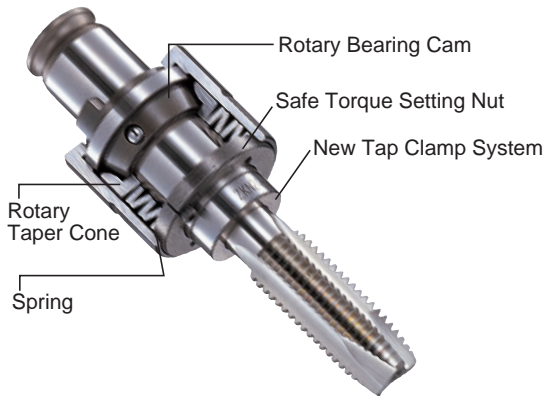
	ZKG12					ZKG16					ZKG24				
	Code.No	D ₄	H	H ₁	ℓ	Code.No	D ₄	H	H ₁	ℓ	Code.No	D ₄	H	H ₁	ℓ
Metric (M)	ZKG12- 2	13	54.5	30.5	72	ZKG16- 3	13	64.5	37.5	85.5	ZKG24- 8	19	73	45	111
	- 3				75	- 4				90.5	-10				116
	- 4				80	- 5				98.5	-12				122
	- 5				88	- 6				100.5	-14				123
	- 6	19	55	31	90	- 8	19	65	38	104	-16	26	74	48	128
	- 8				94	-10				109	-18				128
	-10				99	-12				115	-20				136
	-12				105	-14				116	-22				141
						-16	26	66	42	121	-24	32			144
	Unified (U) or British Standard Whitworth (W)	ZKG12-1/8	13	54.5	30.5	75	ZKG16-1/8	13	64.5	37.5	85.5	ZKG24-1/2	19	73	45
-3/16		88				-3/16	98.5				-9/16	125			
-1/4		90				-1/4	100.5				-5/8	129			
-5/16		93.5				-5/16	104				-3/4	137			
-3/8		19	55	31	99	-3/8	19	65	38	109	-7/8	32	74	48	141
-7/16					103	-7/16				113	-1				149
-1/2					107	-1/2				117					
						-9/16	26	66	42	118					
						-5/8				122					
Pipe (PT) (PS) (PF)	ZKG12-1/8P	19	56	32	83	ZKG16-1/8P	19	66.5	39	93	ZKG24-1/4P	26	75	49	104
	-1/4P				89	-1/4P				97	-3/8P				105
	-1/16P	19	56	32	81.5	-3/8P	26	68.5	44	98	-1/2P	32	75	49	114
	-1/16P-Y				81.5										-5/8P

★ Tap for pipe thread is clamped with the side lock screw.
 ★ High torque setting type example for stainless steel is available. Please add "-HT" at the end of Code No. e.g. **ZKG12-4-HT**
 ★ Low torque setting is "-LT". e.g. **ZKG12-4-LT**
 ★ Please refer P.55 for the long size tap collet.
 ★ The ahank dimension of the 1/16P tap varies depending on the tap maker.
 ★ The internal mechanism of the tap collet for the left handed tap is different from the standard one. Please use the special tap collet for the left handed tap.

ZKN TAP COLLET (JIS)



ZKN Tap Collet



- High Accuracy, Quick Response and Long Tap Life.
- Rotary Bearing Cam Mechanism
NIKKEN ZKG Tap Collet can be used with the all NIKKEN floating Tapper Chucks.
- The torque of CCW is 1.4 times of the torque of CW to prevent the problem of the swarf.
- The setting torque can be adjusted.

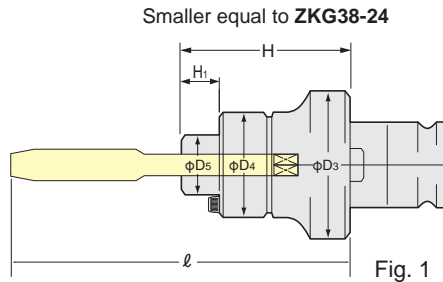


Fig. 1

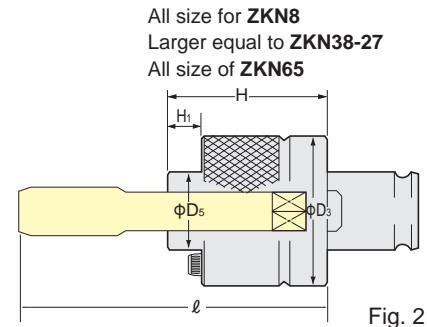


Fig. 2

ZKN65 : The tap collet for the unified thread is also available. (U,W)
 $1\frac{3}{8}$, $1\frac{1}{2}$, $1\frac{5}{8}$, $1\frac{3}{4}$, $1\frac{7}{8}$, 2, $2\frac{1}{4}$,
 $2\frac{1}{2}$, $2\frac{3}{4}$, 3, $3\frac{1}{4}$, $3\frac{1}{2}$, $3\frac{3}{4}$

	ZKN8	ZKN38		ZKN65	
		M18~24	M27~36	M36~65	M68~100
D ₃	23	78		110	125
D ₄	—	56	—	—	—

ZKN8 is semi-standard.

	ZKN 8					ZKN38					ZKN65				
	Code.No	D ₅	H	H ₁	ℓ	Code.No	D ₅	H	H ₁	ℓ	Code.No	D ₅	H	H ₁	ℓ
Metric (M)	ZKN 8-2	13	29.5	6.5	50	ZKN38-18	32	61	17	117	ZKN65- 36	68	89	20	179
	-3				55	-20				121	- 39				187
	-4				56	-22				130	- 42				189
	-5				64	-24				133	- 45				194
	-6				66	-27				142	- 48				198
	-8				73	-30				145	- 52				205
						-33				153	- 56				212
						-36				161	- 60				222
						-38				121	- 64				229
											- 65				229
				- 68	254										
Unified (U) or British Standard Whitworth (W)	ZKN 8-1/8	13	29.5	6.5	55	ZKN38-3/4	32	61	17	122	- 72	84	94	25	254
	-3/16				64	-7/8				130	- 80				264
	-1/4				66	-1				138	-100*				274
						-11/8				145	ZKN65-1P				127
						-11/4				153	-11/8P				135
						-13/8				161	-11/4P				139
											-13/8P				144
											-11/2P				144
											-15/8P				144
											-13/4P				144
Pipe (PT) (PS) (PF)					ZKN38 -3/8P	26	61	17	24	91	-13/4P	84	94	25	144
					-1/2P	32			100	-2P	149				
					-5/8P	32			104	-21/4P	159				
					-3/4P	45			103	-21/2P	174				
					-7/8P	45			106	-23/4P	174				
					-1P	45			109	-3P	174				

★*mark: The Code No. of tap collet for M85 to M90 is ZKN65-100.
 The Code No. of tap collet for M95 to M100 is ZKN65-100N.
 ★The internal mechanism of the tap collet for the left handed tap is different from the standard one. Please use the special tap collet for the left handed tap.

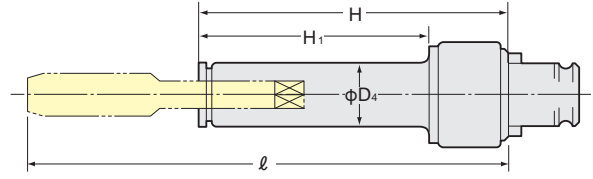
LONG SIZE ONE TOUCH TAP COLLET (ISO)

NIKKEN



ZKG-L

JAPAN PAT.



(ISO)

	ZKG12L					ZKG16L					ZKG24L				
	Code.No	D ₄	H	H ₁	ℓ	Code.No	D ₄	H	H ₁	ℓ	Code.No	D ₄	H	H ₁	ℓ
50mm Long	ZKG12- 3S- 50L	13	104.5	80.5	129	ZKG16- 3S- 50L	13	114.5	87.5	139	ZKG24- 8S- 50L	19	123	95	164
	- 4S- 50L				133	- 4S- 50L				143	-10S- 50L				171
	- 5S- 50L				137	- 5S- 50L				147	-12S- 50L				179
	- 6S- 50L	19	105	81	142	- 6S- 50L	19	115	88	152	-14S- 50L	26	124	98	180
	- 8S- 50L				146	- 8S- 50L				156	-16S- 50L				186
	-10S- 50L				153	-10S- 50L				163	-18S- 50L				195
	-12S- 50L				161	-12S- 50L				171	-20S- 50L				195
						-14S- 50L	26	116	92	172	-22S- 50L	32			195
						-16S- 50L				178	-24S- 50L				205
100mm Long	ZKG12- 3S-100L	13	154.5	130.5	179	ZKG16- 3S-100L	13	164.5	137.5	189	ZKG24- 8S-100L	19	173	145	214
	- 4S-100L				183	- 4S-100L				193	-10S-100L				221
	- 5S-100L				187	- 5S-100L				197	-12S-100L				229
	- 6S-100L	19	155	131	192	- 6S-100L	19	165	138	202	-14S-100L	26	174	148	230
	- 8S-100L				196	- 8S-100L				206	-16S-100L				236
	-10S-100L				203	-10S-100L				213	-18S-100L				245
	-12S-100L				211	-12S-100L				221	-20S-100L				245
						-14S-100L	26	166	142	222	-22S-100L	32			245
						-16S-100L				228	-24S-100L				255

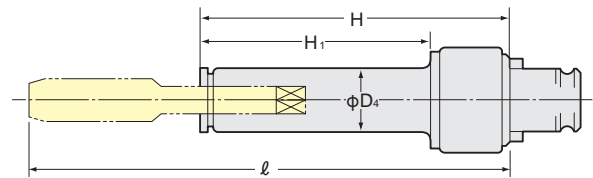
LONG SIZE ONE TOUCH TAP COLLET (JIS)

NIKKEN



ZKG-L

JAPAN PAT.



(JIS)

	ZKG12L					ZKG16L					ZKG24L				
	Code.No	D ₄	H	H ₁	ℓ	Code.No	D ₄	H	H ₁	ℓ	Code.No	D ₄	H	H ₁	ℓ
50mm Long	ZKG12- 3- 50L	13	104.5	80.5	125	ZKG16- 3- 50L	13	114.5	87.5	135.5	ZKG24- 8- 50L	19	123	95	161
	- 4- 50L				130	- 4- 50L				140.5	-10- 50L				166
	- 5- 50L				138	- 5- 50L				148.5	-12- 50L				172
	- 6- 50L	19	105	81	140	- 6- 50L	19	115	88	150.5	-14- 50L	26	124	98	173
	- 8- 50L				144	- 8- 50L				154	-16- 50L				178
	-10- 50L				149	-10- 50L				159	-18- 50L				178
	-12- 50L				155	-12- 50L				165	-20- 50L				186
						-14- 50L	26	116	92	166	-22- 50L	32			191
						-16- 50L				171	-24- 50L				194
100mm Long	ZKG12- 3-100L	13	154.5	130.5	175	ZKG16- 3-100L	13	164.5	137.5	185.5	ZKG24- 8-100L	19	173	145	211
	- 4-100L				180	- 4-100L				190.5	-10-100L				216
	- 5-100L				188	- 5-100L				198.5	-12-100L				222
	- 6-100L	19	155	131	190	- 6-100L	19	165	138	200.5	-14-100L	26	174	148	223
	- 8-100L				194	- 8-100L				204	-16-100L				228
	-10-100L				199	-10-100L				209	-18-100L				228
	-12-100L				205	-12-100L				215	-20-100L				236
						-14-100L	26	166	142	216	-22-100L	32			241
						-16-100L				221	-24-100L				244

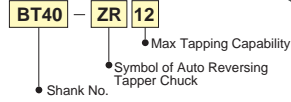
AUTO. REVERSING TAPPER CHUCK

NIKKEN

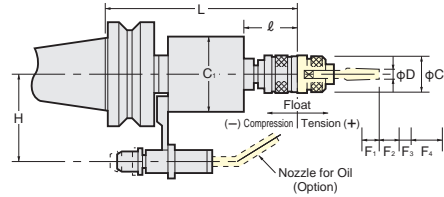


ZR

Explanation of the Code No.

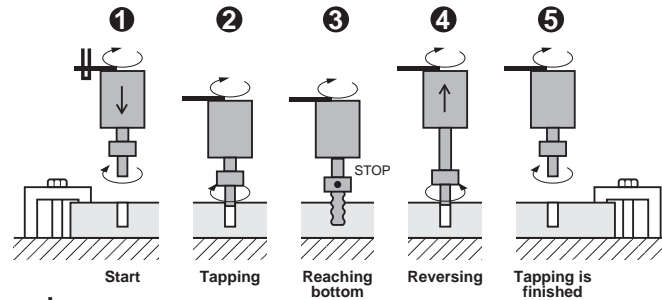
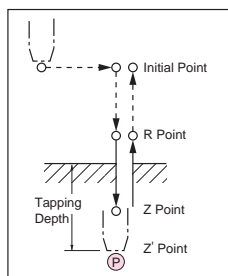


- As Self-Reversing Mechanism is built in Tapper Chuck body, this taper is very suitable for the operation that the main spindle rotates and reverses frequently.
- Floating Mechanism: With a built in Floating Mechanism, High Accuracy Tapping Operations can be achieved.
- Tapping depth can be kept within $\pm 0.1\text{mm}$.



TAPER	Code. No.	Tapping Capability D	L	l	C	C1	H	Float				MAX.min ⁻¹	Weight (Kg)	Tap Collet
								F1	F2	F3	F4			
No.40	BT40-ZR 8*1	M 3 ~ 8	157	43	23	55	60	4	5	2	9	1,500	2.6	ZKN 8
	-ZR12	M 3 ~ 12	171	51	38	70		6	7	4	14	1,000	3.7	ZKG12
	-ZR20	M10 ~ 16	199	66	56	80		6	7	4	14	600	4.8	ZKG16
No.50	BT50-ZR 8*1	M 3 ~ 8	166	43	23	55	82	4	5	2	9	1,500	5.2	ZKN 8
	-ZR12	M 3 ~ 12	180	51	38	70		6	7	4	14	1,000	6.3	ZKG12
	-ZR20	M10 ~ 16	208	66	56	80		6	7	4	14	600	7.5	ZKG16

★Marked *1 ZR8 Tapper Chuck and ZK8 Tap Collet are available as semi-standard.
 ★Please refer P.51 for ISO, IMPERIAL, DIN Tap Collet, P.52 for JIS Tap Collet, and P.53 for Long Size Tap Collet.
 ★Positioning Block is not included. When ordering, please advise name of M/C Builder and Model No. and so on.



Program example of ZR Tapper Chuck

- No. 1 M03 S _____ ; Spindle Rotating
 No. 2 G00 X _____ Y _____ ; Initial Point
 No. 3 Z _____ ; R Point
 No. 4 G01 Z _____ F _____ ; Z Point
 No. 5 G04 P _____ ; Dwell: Only tap going to Z' Point
 No. 6 G01 Z _____ F _____ ; Only tap going to R Point with reversing
 No. 7 G00 Z _____ ;

- ★ZR tapper can be fed one block at a time. Check correct positions at the point No.3-No.5 and input correct values.
- ★Allow about 15mm for distance between Z-Z' (self-feed of the ZR tapper)
- ★Value F of No.4 is tapping self-feeding speed X 0.9.
- ★Value F of No.6 is tapping self-feeding speed X 1.1.

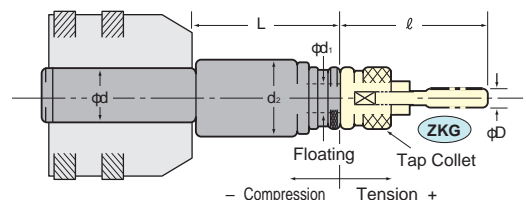
Straight Shank TAPPER CHUCK

NIKKEN

- For Slim body and Ultra Smooth Tapping Operations with Float Mechanism.



NZ



Style	Code. No.	Tapping Capability		L	d1	d	d2	Float		Weight (kg)	Tap Collet
		M	P					Compression	Tension		
32	NZ32-12-105	M 2~12	P1/16 ~ 1/4	105~125	19	32	45	5	15	1.3	ZKG12
	-16-125	M 3~16	P1/8 ~ 3/8	125~145	25		55	8	20	2.2	ZKG16
	-24-140	M 8~24	P1/4 ~ 5/8	140~160	30		63	8	20	2.8	ZKG24
42	NZ42-12-90	M 2~12	P1/16 ~ 1/4	90~125	19	42	45	5	15	2.0	ZKG12
	-16-125	M 3~16	P1/8 ~ 3/8	125~160	25		55	8	20	3.0	ZKG16
	-24-140	M 8~24	P1/4 ~ 5/8	140~175	30		63	8	20	3.6	ZKG24

SYNCHRONIZED TAPPING HOLDER (for 100% Synchronized Feed)

NIKKEN

Synchronized (Rigid or Direct) Tapping Feed Function is one of recent machining function to feed 1 pitch of tap per 1 revolution of machine spindle.

Please use High Run-Out Accuracy & Powerful Gripping of SLIM CHUCK or MULTI LOCK Milling Chuck for this application.

Tapping holder & Collet for 100% Synchronized Tapping

For JIS TAP Shank

For ISO TAP Shank

Metric Tap	Tap Shank Dia.	SLIM CHUCK	SLIM COLLET	MILLING CHUCK	KM COLLET
M 2	3.0	SK10	SK10- 3	C20	KM20- 5.5 KM20- 6 KM20- 6.2 KM20- 7 KM20- 8.5 KM20-10.5 KM20-12.5 KM20-14 KM20-15 KM20-17
M 3	4.0		SK10- 4		
M 4	5.0		SK10- 5		
M 5	5.5		SK10- 5.5		
M 6	6.0		SK10- 6		
M 8	6.2	SK13	SK10- 6.5	C20	KM20-12.5 KM20-14 KM20-15 KM20-17 KM32-19 KM32-20 KM32-23
M10	7		SK13- 7		
M12	8.5		SK13- 8.5		
M14	10.5		SK13-10.5		
M16	12.5		SK13-12.5		
M18	14	SK16	SK16-14	C32	KM32-20 KM32-25
M20	15		SK16-15		
M22	17				
M24	19				
M27	20				
M30	23				

Metric Tap	Tap Shank Dia.	SLIM CHUCK	SLIM COLLET	MILLING CHUCK	KM COLLET
M 2	3.0	SK10	SK10- 3	C20	KM20- 6 KM20- 8 KM20-10 KM20-12
M 3	4.0		SK10- 4		
M 4	6.0		SK10- 6		
M 5	6.0		SK13- 8		
M 6	6.0		SK13-10		
M 8	8.0	SK13	SK13-12	C20	KM20-16
M10	8.0				
M12	10.0				
M14	12.0				
M16	16.0				
M18	16.0	SK16	SK16-16	C32	KM32-20 KM32-25
M20	16.0				
M22	20.0				
M24	20.0				
M27	20.0				
M30	25.0				

★Tap Collet for Tap with Oil Hole is also available.

★At use of MILLING CHUCK, please use tap with shank tolerance h7.

SYNCHRONIZED TAPPING HOLDER (with fine floating)

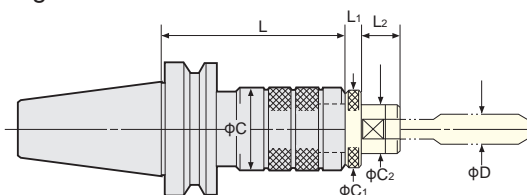
NIKKEN

This fine floating tapping holder improves tap life remarkably by absorbing fine pitch error completely with the small floating mechanism.



NEW

Center Through Tool Coolant



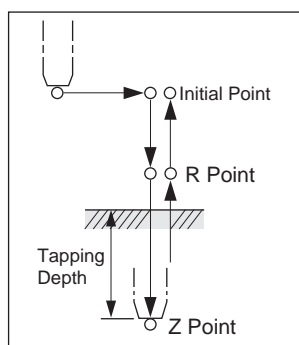
ZH-C

OZMK-OM Tap Collet

TAPER	Code No.	L	C	Weight (kg)	Tap Collet
No.40	BT40-ZH12CH- 80	80	36	1.2	ZMK12 OZMK12-OM
	-105	105		1.5	
	-135	135		1.8	
	-ZH16CH- 95	95		1.5	ZMK16 OZMK16-OM
	-120	120	45	1.9	
	-150	150	2.3		
	-ZH24CH-105	105	56	1.8	ZMK24 OZMK24-OM
	-120	120		2.0	
-150	150	2.4			
No.50	BT50-ZH12CH- 90	90		36	3.9
	-135	135	4.3		
	-165	165	4.6		
	-200	200	5.0		
	-ZH16CH-105	105	45	4.2	ZMK16 OZMK16-OM
	-135	135		4.6	
	-165	165		5.0	
	-200	200		5.5	
	-ZH24CH-105	105	56	4.4	ZMK24 OZMK24-OM
	-135	135		5.0	
	-165	165		5.6	
	-200	200		6.2	

	OZMK12-OM		OZMK16-OM			OZMK24-OM		
D	M8	M8-M12	M6	M8-M12	M14-M16	M12	M14-M16	M18-M24
D ₂	19		25			30		
D ₃	28		36			42		
D ₄	13	19	13	19	26	19	26	32
H	16	20	21			29		
H ₁	6		6			8		
G	M4-0.5	M6-0.75	M4-0.5	M6-0.75		M6-0.75	M8-1.0	

Example of RIGID TAP cycle



No.1 MO3 S ... ; Spindle Rotation
No.2 G84.2 X ... Y ... Z ... R ... F ... ;
Rigid Tap Cycle Initial point R point ★Feed

★F is calculated by Pitch of Tap and Spindle Rotation Speed.

For example, in case of M10×P1.5 and S400min⁻¹ (Cutting Speed 12.6m/min.) then F = 1.5mm×400min⁻¹ = 600 mm/min.

★Please use OZMK-OM tap collet for center through tool coolant.

★Please use ZMK P.56 tap collet for external coolant. In this case, the spacer attached as standard accessory is put on a tap holder.

ZH Tapping Holder has fine floating mechanism, but it's not standard floating system (Tension/Compression) like Z or ZL Tap Holder.

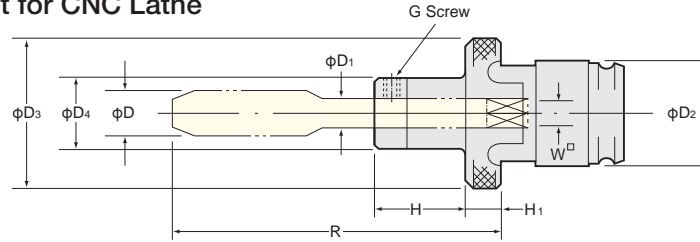
Therefore, please use this ZH Tap Holder only with synchronized tapping cycle, not with ordinary tapping cycle.

TAP COLLET without TORQUE CONTROL (JIS)

NIKKEN



- Tap Collet for ZH Tapping Holder
- Tap Collet for CNC Lathe



ZMK

For Synchronized Tapping on M/C, use ZMK tap collet with ZH Tapping Holder, Please refer P.57.

⚠ Torque Control is not built-in. Careful attention must be paid to diameter of drilled hole, program and so on.

Dimension List of ZMK Tap Collet

D	ZMK8		ZMK12		ZMK16			ZMK24		
	M3~6	M8	M3~6	M8~12	M4~6	M8~12	M14~16	M12	M14~16	M18~24
D ₂	13		19		25			30		
D ₃	20		28		36			42		
D ₄	13	19	13	19	13	19	26	19	26	32
H	14	24	16	20	21			25		29
H ₁	4		6		6			8		
G	M4-0.5	M6-0.75	M4-0.5	M6-0.75	M4-0.5	M6-0.75		M6-0.75	M8-1.0	

	ZMK 8				ZMK12				ZMK16				ZMK24			
	Code No.	D ₁	W	ℓ	Code No.	D ₁	W	ℓ	Code No.	D ₁	W	ℓ	Code No.	D ₁	W	ℓ
Metric (M)	ZMK8-3	4	3.2	43.5	ZMK12-3	4	3.2	47.5	ZMK16-4	5	4.0	53.5	ZMK24-12	8.5	6.5	83
	-4	5	4.0	44.5	-4	5	4.0	48.5	-5	5.5	4.5	61.5	-14	10.5	8.0	84
	-5	5.5	4.5	52.5	-5	5.5	4.5	56.5	-6	6	4.5	63.5	-16	12.5	10.0	89
	-6	6	4.5	54.5	-6	6	4.5	58.5	-8	6.2	5.0	66	-18	14	11.0	93
	-8	6.2	5.0	67	-8	6.2	5.0	65	-10	7	5.5	71	-20	15	12.0	97
Unified (U) or British Standard Whitworth (W)	ZMK8-1/8	4	3.2	43.5	ZMK12-1/8	4	3.2	47.5	ZMK16-1/8	4	3.2	52.5	ZMK24-1/2	9	7.0	85
	-3/16	5	4.5	52.5	-3/16	5.5	4.5	56.5	-3/16	5	4.5	61.5	-9/16	10.5	8.0	86
	-1/4	6	4.5	54.5	-1/4	6	4.5	58.5	-1/4	6	4.5	63.5	-5/8	12	9.0	90
					-5/16	6.1	5.0	65	-5/16	6.1	5.0	66	-3/4	14	11.0	98
					-3/8	7	5.5	70	-3/8	7	5.5	71	-7/8	17	13.0	106
					-7/16	8	6.0	74	-7/16	8	6.0	75	-1	20	15.0	114
Pipe (PT) (PF)					-1/2	9	7.0	78	-1/2	9	7.0	79				
					ZMK12-1/8P	8	6.0	51	ZMK16-1/8P	8	6.0	54	ZMK24-3/8P	14	11.0	63
									-1/4P	11	9.0	56	ZMK24-1/2P	18	14.0	76
									-3/8P	14	11.0	57	ZMK24-5/8P	19	15.0	80

*For long size Tap Collets are also available. 50mm (-50L), 100mm (-100L) longer than standard type. e.g. ZMK12-4-50L

OLD SYNCHRONIZED TAPPING HOLDER (with fine floating)

NIKKEN



ZH

The sales of old ZH holder will be finished, when the stock is sold out. Please use ZH-C holder P.57

TAPER	Code No.	L	C	Weight (kg)	Tap collet
No.40	BT40-ZH 8-75	75	23	1.1	ZMK 8
	ZH12-80	80	36	1.2	ZMK12
	ZH16-95	95	45	1.5	ZMK16
	ZH24-105	105	56	1.8	ZMK24
No.50	BT50-ZH 8-90	90	23	3.8	ZMK 8
	ZH12-90	90	36	3.9	ZMK12
	ZH16-105	105	45	4.2	ZMK16
	ZH24-105	105	56	4.4	ZMK24

B1

ROUGH BORING

Steel, Stainless Steel, Cast Iron
RAC-E P.61



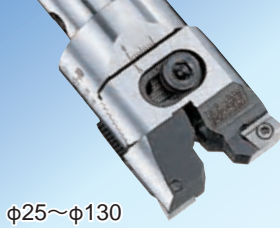
CC
 Positive type
 $\phi 25 \sim \phi 130$

Heavy Duty Boring
RAC P.63



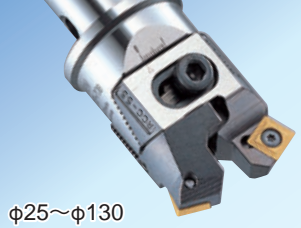
CN
 Negative type
 $\phi 43 \sim \phi 130$

Aluminium
RAC-A P.65



$\phi 25 \sim \phi 130$

Through Hole / Multi Sheets
RAC-K P.67



$\phi 25 \sim \phi 130$

SEMI-FINISH BORING

ZMAC-R P.75



$\phi 32 \sim \phi 180$

ZMAC P.73



$\phi 16 \sim \phi 180$

FINISH BORING

ZMAC-X P.78



$\phi 25 \sim \phi 180$

DJ P.83



$\phi 3 \sim \phi 50$

BORING ARBOR FOR LARGE DIA

Roughing
RAC P.71



$\phi 130 \sim \phi 580$

Roughing · Finishing
BCB P.80



$\phi 130 \sim \phi 595$

Finishing
BAC P.79



$\phi 130 \sim \phi 595$

SPECIAL BORING

Multi-Stage, External P.91



MODULAR SYSTEM

Base Holder
Q P.85



Spacer
SP P.86



STRAIGHT SHANK

K-RAC P.89
K-ZMAC P.89
K-DJ P.91



S-BCBX P.90
S-ZMACX P.90



$\phi 12.7 \sim \phi 55$

COOLANT THROUGH TOOL

High pressure coolant through tool is available for all boring heads.

RAC-C



ZMAC-C



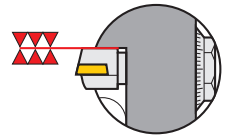
DJ-C



RAC / BAC-C for LARGE DIA.



MODULAR ZMAC BORING BAR



BASE-HOLDER

Q26 type base holder can be used for various combinations. Ideal for low volume production on manual machine with wide variety of boring sizes. We recommend that you also use the Q42 base holder on #50 M/C.

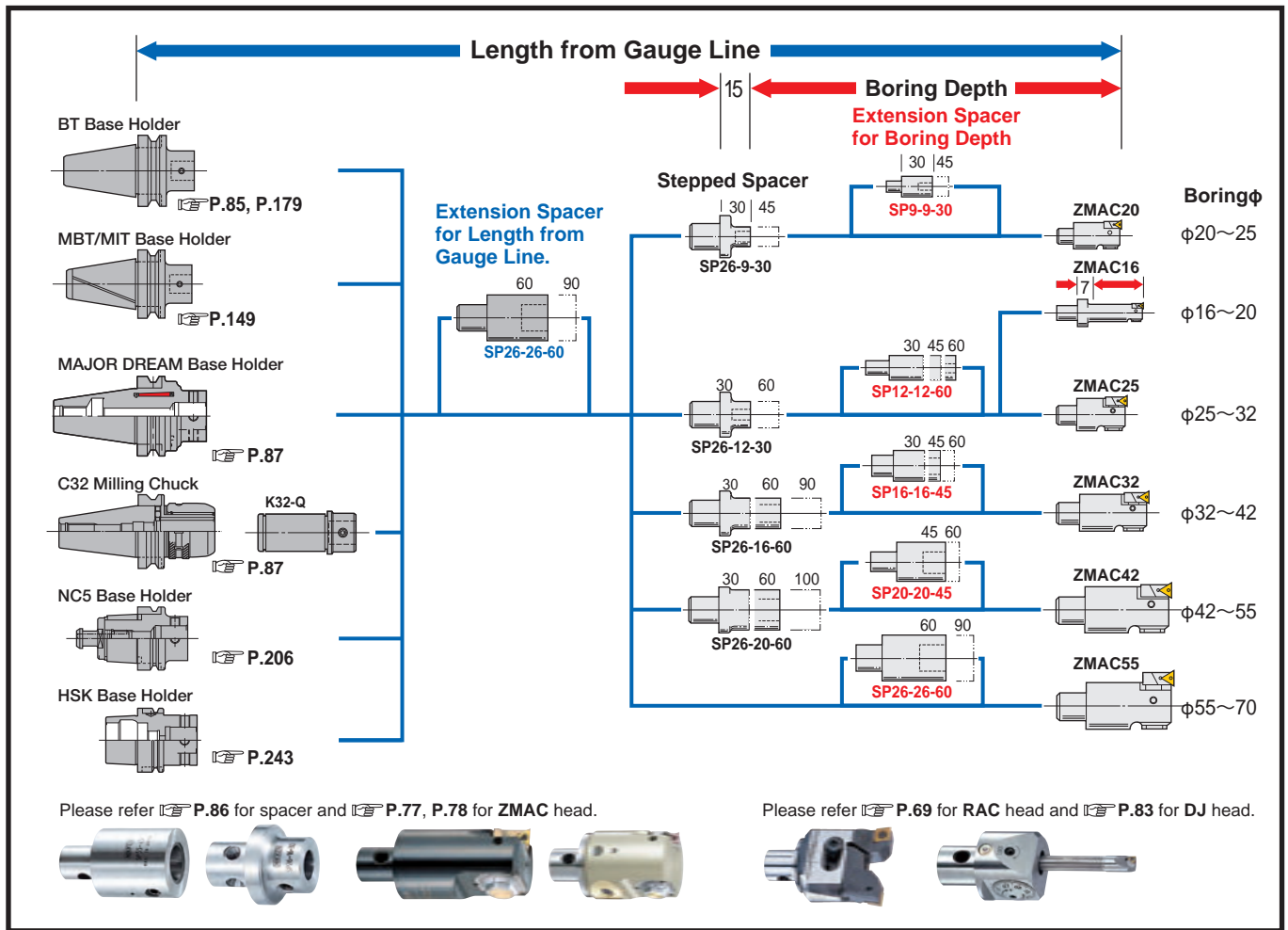
Spacer & Head

The extensive range of heads & spacers allow the correct selection to suit your boring applications.

No Micro Vibration due to Double-Contact Support of Cartridge. Long Tool-Life & High Accuracy.

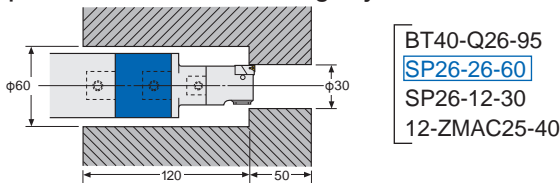
Method of Selection for Modular ZMAC Boring Arbors

Firstly, select a head, spacer and stepped spacer from boring diameter and depth. Then select base holder and SP26 extension spacer by the length from gauge line.



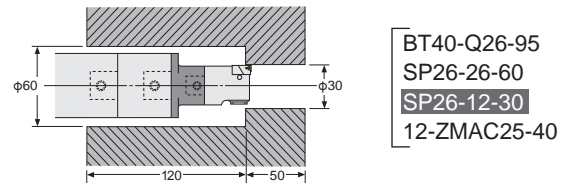
Extension Spacer

Example of small diameter boring in a deep recess using the largest diameter extension spacer in order to maintain rigidity.

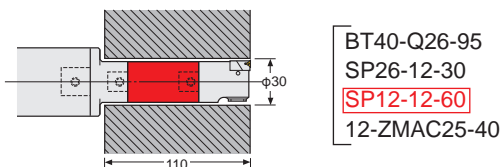


Stepped Spacer

Example of small diameter boring in deep recess using stepped spacer with the same diameter as head.



Example of deep hole boring using the extension spacer with the same diameter as head.



A1 Spacer

The combination of A1 spacer and ZMAC head is recommended when L/D is less than 6 times.



BALANCE-CUT BORING ARBOR (RAC-E)



Rough Boring — For Steel, Stainless Steel and Cast Iron
CC Insert (Positive type)



RAC-E

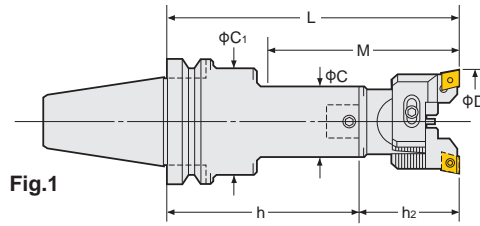


Fig.1

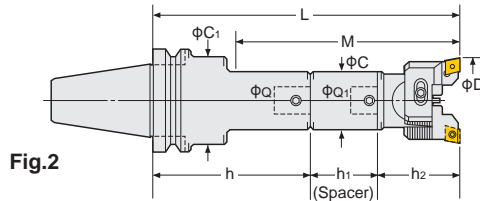
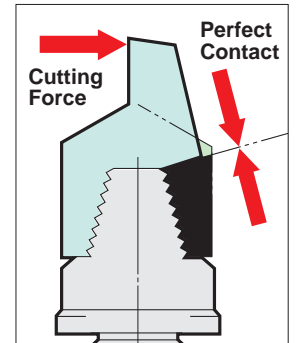


Fig.2

Power of Shoulder Support



TAPER	Code No.	Boring Range D	Boring Depth M	Cupling Dia Q	C	C ₁	Shank Code No.	Spacer Code No.	P.62		Weight (kg)	Fig
									Head Code No.	Tip No.		
No.40	BT40-RAC 25-135E	25~32	67	12	24	35	BT40-Q12- 80	—	12-RAC025- 55E	CC07-C	2.0	1
	(IT40) -165E		105				-Q12-110				2.1	
	-180E		112				-Q12- 80				2.1	
	-RAC 32-150E	32~45	77	16	31	42	-Q16- 95	—	16-RAC 32- 55E	CC08-C	2.4	1
	-180E		110				-Q16-125				2.6	
	-195E		122				-Q16- 95				2.6	
	-RAC 43-150E	43~55	97	20	40	50	-Q20- 80	—	20-RAC 43- 70E	—	2.7	1
	-180E		130				-Q20-110				2.9	
	-210E		157				-Q20- 80				3.2	
	-RAC 53-165E	53~70	135	26	50	50	-Q26- 95	—	26-RAC 53- 70E	CC12-C	2.5	1
	-210E		180				-Q26-140				3.3	
	-225E		195				-Q26- 95				3.2	
	-RAC 70-180E	70~100	180	34	64	64	-Q34- 95	—	34-RAC 70- 85E	—	4.8	1
	-195E		195				-Q34-110				5.2	
	-240E		240				-Q34- 95				6.2	
	-RAC100-195E	100~130	195	42	83	62	-Q42- 95	—	42-RAC100-100E	—	6.8	1

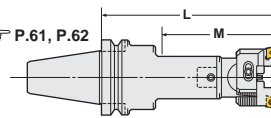
★“C” grade (Coated) inserts are supplied as standard with the head. P.62 Please refer P.93 for cutting condition.

★Please refer P.85 for base holder, P.86 for spacer and P.67 for head.

★For centre through tool coolant type, please add “-C” at the end of Code No. e.g. BT40-RAC53-165-C
Code No. of RAC25 and RAC32 with CC inserts are changed to RAC25E and RAC32E. Please refer P.61, P.62

★When L length is required longer than standard, please specify the boring depth M.

★Code No. of RAC25 and RAC32 are changed to RAC25E and RAC32E.
e.g. BT40-RAC25-135 → BT40-RAC25-135E
12-RAC25- 55 → 12-RAC25- 55E



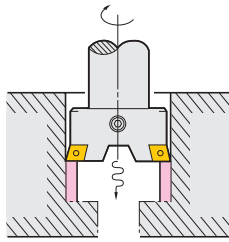
High Pressure Coolant Through Tool

BALANCE-CUT BORING ARBOR (RAC-E)

NIKKEN

Balance cut boring bar executes boring in 2 cartridge inserts absorbing the vibration each other. The faster the feed rate, the better swarf ejection. This is ideal for rough and medium boring.

Double Cutting Capability

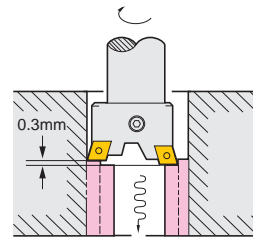


Please use RAC-K for through hole boring.

☞ P.67, P.68



Example of 2 Stepped Balance Cut



Approx. double removal of below cutting condition is possible by -0.3 Cartridge.
☞ P.70

TAPER	Code No.	Boring Range D	Boring Depth M	Cupling Dia Q	C	C ₁	Shank Code No.	Spacer Code No.	P.62		Weight (kg)	Fig
									Head Code No.	Tip No.		
No.50	BT50-RAC 25-150E	25~ 32	67	12	24	44	BT50-Q12- 95	—	12-RAC025- 55E	CC07-C	4.7	1
	(IT50) -180E		105				4.9					
	-195E		112				4.8					
	-RAC 32-180E	32~ 45	77	16	31	50	-Q16-125N	—	16-RAC 32- 55E	CC08-C	5.4	1
	-210E		110				5.6					
	-225E		122				5.6					
	-RAC 43-180E	43~ 55	97	20	40	60	-Q20-110	—	20-RAC 43- 70E	—	5.7	1
	-195E		130				5.8					
	-225E		142				6.1					
	-240E		157				6.2					
	-RAC 53-210E	53~ 70	117	26	50	65	-Q26-140	—	26-RAC 53- 70E	—	6.9	1
	-240E		182				7.0					
	-270E		177				7.6					
	-RAC 70-255E	70~100	205	34	64	80	-Q34-170	—	34-RAC 70- 85E	—	9.5	1
	-285E		235				9.9					
	-315E		265				10.9					
	-RAC100-225E		225				12.5					
	-290E	100~130	290	42	83	83	-Q42-125	—	42-RAC100-100E	—	15.2	1
-290E	290		15.2									
-325E	325		16.5									

★“C” grade (Coated) inserts are supplied as standard with the head. ☞ P.62 Please refer ☞ P.95 for cutting condition. ★Code No. of RAC25 and RAC32 with CC inserts are changed to RAC25E and RAC32E.
★Please refer ☞ P.85 for base holder, ☞ P.86 for spacer and ☞ P.69 for head. e.g. BT50-RAC25-150 → BT50-RAC25-150E
★For centre through tool coolant type, please add “-C” at the end of Code No. e.g. BT50-RAC53-210E-C
★BT50-RAC100-375E, 425E and 475E are also available. 12-RAC25- 55 → 12-RAC25- 55E

Insert tip for RAC-E

● : best ○ : good

Material	Steel		●	○
	Stainless Steel		●	○
	Cast Iron		○	●
Aluminium		○	●	
		Coated Carbide M	C	
		Grade	Material	
			AC630M	AC410K
Applicable Arbor	Dimension	Code No.	Nose R	
RAC025E		CC07-○4	0.4	● ●
		CC07-○8	0.8	● ●
RAC25E, RAC32E		CC08-○4	0.4	● ●
		CC08-○8	0.8	● ●
RAC43E - RAC530E		CC12-○4	0.4	● ●
		CC12-○8	0.8	● ●

Please add the grade indication into ○, and add the insert tip material indication at the end of the Code No. e.g. CC12-C8 (AC630M)

★Minimum order quantity : 10pcs.

BALANCE-CUT BORING ARBOR (RAC)

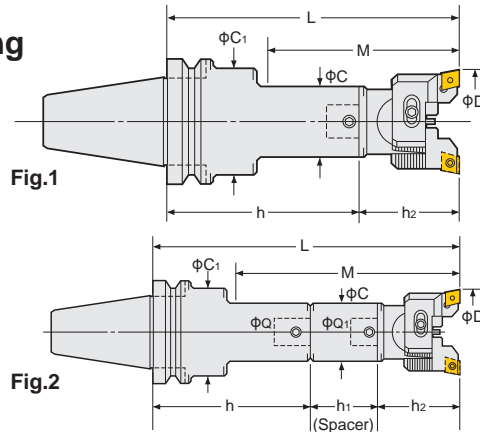


Rough Boring — For Heavy Duty Boring of Iron and Cast Iron
CN Insert (Negative type)

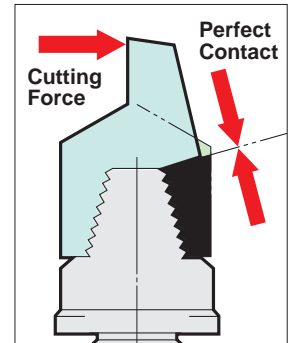


Heavy Duty Boring

RAC



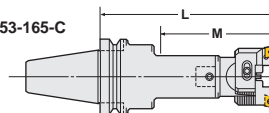
Power of Shoulder Support



TAPER	Code No.	Boring Range D	Boring Depth M	Cupling Dia Q	C	C ₁	Shank Code No.	Spacer Code No.	P.64		Weight (kg)	Fig
									Head Code No.	Tip No.		
No.40	BT40-RAC 43-150	43~55	97	20	40	50	BT40-Q20- 80	—	20-RAC 43- 70	CN08-C	2.7	1
	(IT40) -180		130				-Q20- 110	SP20-20-60			2.9	
	-210		157				-Q20- 80	—			3.2	
	-RAC 53-165	53~70	135	26	50	64	-Q26- 95	—	26-RAC 53- 70	2.5	1	
	-210		180				-Q26-140	—		3.3		
	-225		195				-Q26- 95	SP26-26-60		3.2		
	-RAC 70-180	70~100	180	34	64	64	-Q34- 95	—	34-RAC 70- 85	4.8	1	
	-195		195				-Q34-110	—		5.2		
	-240		240				-Q34- 95	SP34-34-60		6.2		
	-RAC100-195	100~130	195	42	83	62	-Q42- 95	—	42-RAC100-100	6.8	1	

- ★“C” grade (Coated) inserts are supplied as standard with the head. P.64 Please refer P.95 for cutting condition.
- ★Please refer P.85 for base holder, P.86 for spacer and P.69 for head.
- ★For centre through tool coolant type, please add “-C” at the end of Code No. e.g. BT40-RAC53-165-C
- ★When L length is required longer than standard, please specify the boring depth M.

★Code No. of RAC25 and RAC32 with CC inserts are changed to RAC25E and RAC32E. Please refer P.61, P.62



High Pressure Coolant Through Tool

BALANCE-CUT BORING ARBOR (RAC)

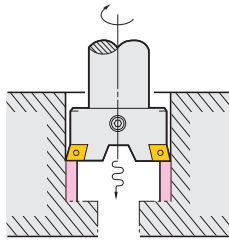
NIKKEN

Balance cut boring bar executes boring in 2 cartridge inserts absorbing the vibration each other. The faster the feed rate, the better swarf ejection. This is ideal for rough and medium boring.

Double Cutting Capability

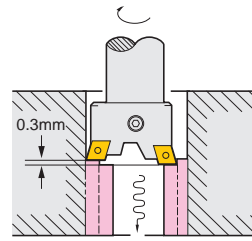
Please use RAC-K for through hole boring.

☞ P.67, P.68



Example of 2 Stepped Balance Cut

Approx. double removal of below cutting condition is possible by -0.3 Cartridge. ☞ P.70



TAPER	Code No.	Boring Range D	Boring Depth M	Coupling Dia Q	C	C ₁	Shank Code No.	Spacer Code No.	P.64		Weight (kg)	Fig
									Head Code No.	Tip No.		
No.50	BT50-RAC 43-180	43~ 55	97	20	40	60	BT50-Q20-110	—	20-RAC 43- 70	CN08-C	5.7	1
	(IT50) -195		130				-Q20-125				5.8	
	-225		142				-Q20-110				6.1	2
	-240		157				SP20-20-45				6.2	
	-RAC 53-210	53~ 70	117	26	50	65	-Q26-140	—	26-RAC 53- 70	CN08-C	6.9	1
	-240		182				-Q26-170N				7.0	
	-270		177				-Q26-140				7.6	2
	-RAC 70-255	70~100	205	34	64	80	-Q34-170	—	34-RAC 70- 85	CN08-C	9.5	1
	-285		235				-Q34-200				9.9	
	-315		265				-Q34-170				10.9	2
	-RAC100-225	100~130	225	42	83	83	-Q42-125	SP34-34-60	42-RAC100-100	CN08-C	12.5	1
	-290		290				-Q42-190				15.2	
	-325		325				-Q42-225A				16.5	2

★“C” grade (Coated) inserts are supplied as standard with the head. ☞ P.64 Please refer ☞ P.95 for cutting condition. ★Code No. of RAC25 and RAC32 with CC inserts are changed to RAC25E and RAC32E. Please refer P.61, P.62
 ★Please refer ☞ P.85 for base holder, ☞ P.86 for spacer and ☞ P.69 for head.
 ★For centre through tool coolant type, please add “-C” at the end of Code No. e.g. BT50-RAC53-210-C
 ★BT50-RAC100-375, 425 and 475 are also available.

Insert tip for RAC for Heavy Duty Boring

Material	Steel	●	
	Stainless Steel	●	
Material	Cast Iron	●	
	Aluminium	●	
		Coated Carbide M	
		Grade C	
		Material AC630M	
Applicable Arbor	Dimension	Code No.	Nose R
RAC43 - RAC530		CN08-○8	0.8 ●

Please add the grade indication into ○, and add the insert tip material indication at the end off the Code No. e.g. CC08-C8 (AC630M)

★Minimum order quantity : 10pcs.
 ★When CN08 insert (CN○○1204○○) in the market is used, please use the eccentric bolt type cartridge (S.RCC-○○Q) ☞ P.92. Nikken CN08-○8 insert can be used on the eccentric bolt type cartridge.

BT

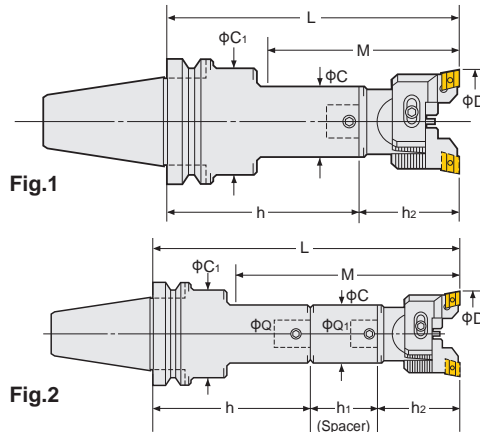
BALANCE-CUT BORING ARBOR (RAC-A)



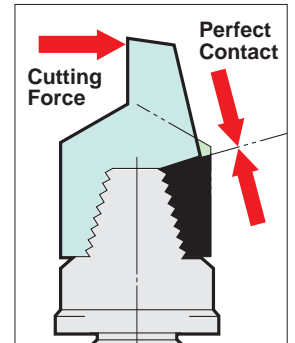
Rough Boring—For Aluminium



RAC-A

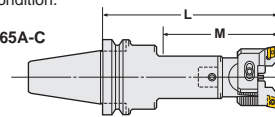


Power of Shoulder Support



TAPER	Code No.	Boring Range D	Boring Depth M	Cupling Dia Q	C	C ₁	Shank Code No.	Spacer Code No.	P.66		Weight (kg)	Fig
									Head Code No.	Tip No.		
No.40	BT40-RAC 25-135A	25~32	67	12	24	35	BT40-Q12- 80	—	12-RAC 25- 55A	AEG12	2.0	1
	(IT40) -165A		105				-Q12-110				2.1	
	-180A		112				-Q12- 80				2.1	
	-RAC 32-150A	32~45	77	16	31	42	-Q16- 95	—	16-RAC 32- 55A	AEG12	2.4	1
	-180A		110				-Q16-125				2.6	
	-195A		122				-Q16- 95				2.6	
	-RAC 43-150A	43~55	97	20	40	50	-Q20- 80	—	20-RAC 43- 70A	AEG16	2.7	1
	-180A		130				-Q20-110				2.9	
	-210A		157				-Q20- 80				3.2	
	-RAC 53-165A	53~70	135	26	50	50	-Q26- 95	—	26-RAC 53- 70A	AEG16	2.5	1
	-210A		180				-Q26-140				3.3	
	-225A		195				-Q26- 95				3.2	
	-RAC 70-180A	70~100	180	34	64	64	-Q34- 95	—	34-RAC 70- 85A	AEG16	4.8	1
	-195A		195				-Q34-110				5.2	
	-240A		240				-Q34- 95				6.2	
	-RAC100-195A	100~130	195	42	83	62	-Q42- 95	—	42-RAC100-100A		6.8	1

- ★“F” grade inserts are supplied as standard with the head. P.66 Please refer P.95 for cutting condition.
- ★Please refer P.85 for base holder, P.86 for spacer and P.69 for head.
- ★For centre through tool coolant type, please add “-C” at the end of Code No. e.g. BT40-RAC53-165A-C
- ★When L length is required longer than standard, please specify the boring depth M.



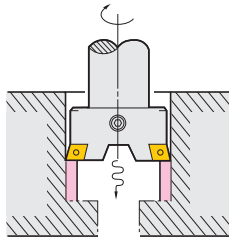
High Pressure Coolant Through Tool

BALANCE-CUT BORING ARBOR (RAC-A)

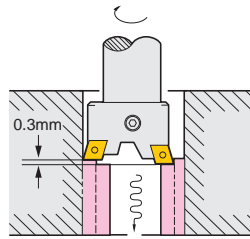
NIKKEN

Balance cut boring bar executes boring in 2 cartridge inserts absorbing the vibration each other. The faster the feed rate, the better swarf ejection. This is Ideal for rough and medium boring.

Double Cutting Capability



Example of 2 Stepped Balance Cut



Approx. double removal of below cutting condition is possible by **-0.3 Cartridge**.
 ☞ P.70

TAPER	Code No.	Boring Range D	Boring Depth M	Coupling Dia Q	C	C ₁	Shank Code No.	Spacer Code No.	P.66		Weight (kg)	Fig
									Head Code No.	Tip No.		
No.50	BT50-RAC 25-150A	25~ 32	67	12	24	44	BT50-Q12- 95	—	12-RAC 25- 55A	AEG12	4.7	1
	(IT50) -180A		105				-Q12-125	—			4.9	
	-195A		112				-Q12- 95	SP12-12-45			4.8	
	-RAC 32-180A	32~ 45	77	16	31	50	-Q16-125N	—	16-RAC 32- 55A	AEG12	5.4	1
	-210A		110				-Q16-155	—			5.6	
	-225A		122				-Q16-125N	SP16-16-45			5.6	
	-RAC 43-180A	43~ 55	97	20	40	60	-Q20-110	—	20-RAC 43- 70A	AEG16	5.7	1
	-195A		130				-Q20-125	—			5.8	
	-225A		142				-Q20-110	SP20-20-45			6.1	
	-240A		157				-Q20-110	SP20-20-60			6.2	
	-RAC 53-210A	53~ 70	117	26	50	65	-Q26-140	—	26-RAC 53- 70A	AEG16	6.9	1
	-240A		182				-Q26-170N	—			7.0	
	-270A		177				-Q26-140	SP26-26-60			7.6	
	-RAC 70-255A	70~100	205	34	64	80	-Q34-170	—	34-RAC 70- 85A	AEG16	9.5	1
	-285A		235				-Q34-200	—			9.9	
	-315A		265				-Q34-170	SP34-34-60			10.9	
	-RAC100-225A	100~130	225	42	83	83	-Q42-125	—	42-RAC100-100A	AEG16	12.5	1
	-290A		290				-Q42-190	—			15.2	
-325A	325		-Q42-225A				—	16.5				

★“F” grade inserts are supplied as standard with the head. ☞ P.66 Please refer ☞ P.95 for cutting condition.

★Please refer ☞ P.85 for base holder, ☞ P.86 for spacer and ☞ P.69 for head.

★For centre through tool coolant type, please add “-C” at the end of Code No. e.g. BT50-RAC53-210A-C

★BT50-RAC100-375A, 425A and 475A are also available.

Insert tip for RAC-A

Material	Steel		Grade	Material
	Stainless Steel			
Cast Iron		Aluminium		F
Aluminium		Coated Carbide K		
Applicable Arbor	Dimension	Code No.	Nose R	KW10
RAC25A, RAC32A		AEG12-○1	0.1	●
		AEG12-○2	0.2	●
		AEG12-○4	0.4	●
RAC43A-RAC530A		AEG16-○1	0.1	●
		AEG16-○2	0.2	●
		AEG16-○4	0.4	●

Please add the grade indication into ○, and add the insert tip material indication at the end off the Code No.
 e.g. AEG16-F2 (KW10)

★Minimum order quantity : 10pcs.

BT

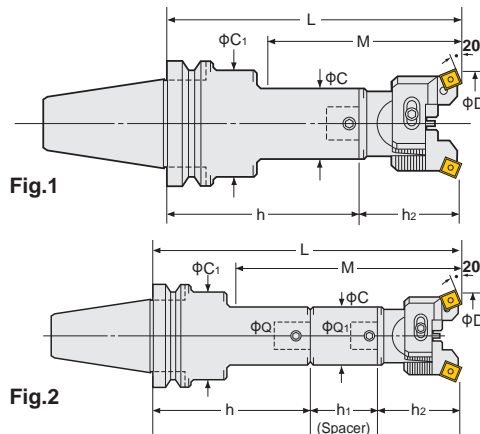
BALANCE-CUT BORING ARBOR (RAC-K)

NIKKEN

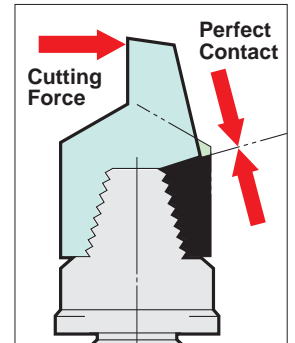
Rough Boring—For Through Hole and Multi Sheets



RAC-K

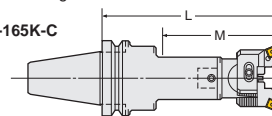


Power of Shoulder Support



TAPER	Code No.	Boring Range D	Boring Depth M	Cupling Dia Q	C	C ₁	Shank Code No.	Spacer Code No.	P.68		Weight (kg)	Fig
									Head Code No.	Tip No.		
No.40	BT40-RAC 25-135K	25~32	67	12	24	35	BT40-Q12- 80	—	12-RAC 25- 55K	SC09	2.0	1
	(IT40) -165K		105				-Q12-110				2.1	
	-180K		112				-Q12- 80				2.1	
	-RAC 32-150K	32~45	77	16	31	42	-Q16- 95	—	16-RAC 32- 55K	SC12	2.4	1
	-180K		110				-Q16-125				2.6	
	-195K		122				-Q16- 95				2.6	
	-RAC 43-150K	43~55	97	20	40	50	-Q20- 80	—	20-RAC 43- 70K	SC12	2.7	1
	-180K		130				-Q20-110				2.9	
	-210K		157				-Q20- 80				3.2	
	-RAC 53-165K	53~70	135	26	50	64	-Q26- 95	—	26-RAC 53- 70K	SC12	2.5	1
	-210K		180				-Q26-140				3.3	
	-225K		195				-Q26- 95				3.2	
	-RAC 70-180K	70~100	180	34	64	64	-Q34- 95	—	34-RAC 70- 85K	SC12	4.8	1
	-195K		195				-Q34-110				5.2	
	-240K		240				-Q34- 95				6.2	
	-RAC100-195K	100~130	195	42	83	62	-Q42- 95	—	42-RAC100-100K	SC12	6.8	1

★“C” grade (Coated) inserts are supplied as standard with the head. P.68 Please refer P.95 for cutting condition.
 ★Please refer P.85 for base holder, P.86 for spacer and P.69 for head.
 ★For centre through tool coolant type, please add “-C” at the end of Code No. e.g. BT40-RAC53-165K-C
 ★When L length is required longer than standard, please specify the boring depth M.



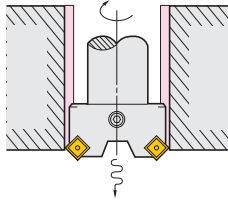
High Pressure Coolant Through Tool

BALANCE-CUT BORING ARBOR (RAC-K)

NIKKEN

Balance cut boring bar executes boring in 2 cartridge inserts absorbing the vibration each other. The faster the feed rate, the better swarf ejection. This is Ideal for rough and medium boring.

Double Cutting Capability



TAPER	Code No.	Boring Range D	Boring Depth M	Coupling Dia Q	C	C ₁	Shank Code No.	Spacer Code No.	P.68		Weight (kg)	Fig
									Head Code No.	Tip No.		
No.50	BT50-RAC 25-150K	25~ 32	67	12	24	44	BT50-Q12- 95	—	12-RAC 25- 55K	SC09	4.7	1
	(IT50) -180K		105				-Q12-125	—			4.9	
	-195K		112				-Q12- 95	SP12-12-45			4.8	2
	-RAC 32-180K	32~ 45	77	16	31	50	-Q16-125N	—	16-RAC 32- 55K	SC09	5.4	1
	-210K		110				-Q16-155	—			5.6	
	-225K		122				-Q16-125N	SP16-16-45			5.6	2
	-RAC 43-180K	43~ 55	97	20	40	60	-Q20-110	—	20-RAC 43- 70K	SC12	5.7	1
	-195K		130				-Q20-125	—			5.8	
	-225K		142				-Q20-110	SP20-20-45			6.1	2
	-240K		157				-Q20-110	SP20-20-60			6.2	
	-RAC 53-210K	53~ 70	117	26	50	65	-Q26-140	—	26-RAC 53- 70K	SC12	6.9	1
	-240K		182				-Q26-170N	—			7.0	
	-270K		177				-Q26-140	SP26-26-60			7.6	2
	-RAC 70-255K	70~100	205	34	64	80	-Q34-170	—	34-RAC 70- 85K	SC12	9.5	1
	-285K		235				-Q34-200	—			9.9	
	-315K		265				-Q34-170	SP34-34-60			10.9	2
	-RAC100-225K	100~130	225	42	83	83	-Q42-125	—	42-RAC100-100K	SC12	12.5	1
	-290K		290				-Q42-190	—			15.2	
	-325K		325				-Q42-225A	—			16.5	2

★“C” grade (Coated) inserts are supplied as standard with the head. P.68 Please refer P.95 for cutting condition.

★Please refer P.85 for base holder, P.86 for spacer and P.69 for head.

★For centre through tool coolant type, please add “-C” at the end of Code No. e.g. BT50-RAC53-210K-C

★BT50-RAC100-375K, 425K and 475K are also available.

Insert tip for RAC-K

● : best ○ : good

Material	Steel	●	○		
	Stainless Steel	●	○		
Material	Cast Iron	○	●		
	Aluminium	○	○		
Applicable Arbor	Dimension	Code No.	Nose R	Coated Carbide M	Coated Carbide K
				Grade	C
Material	Nose R	AC630M	AC410K		
				RAC25K, RAC32K	
RAC43K-RAC100K		SC12-○8	0.8	●	●

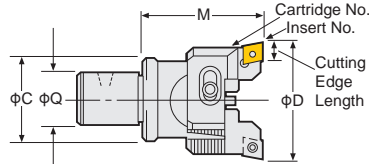
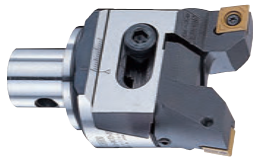
Please add the grade indication into ○, and add the insert tip material indication at the end off the Code No. e.g. SC12-C8 (AC630M)

★Minimum order quantity : 10pcs.

MODULAR TYPE RAC BORING HEAD

NIKKEN

RAC-E Balance-Cut Boring Head



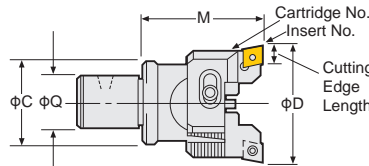
For Steel, Stainless Steel and Cast Iron
CC Insert (Positive type)

P.62

Head Code No.	Boring Range D	Boring Depth M	Coupling Dia Q	C	Cartridge No.	Insert No.	Cutting Edge Length	Weight (Kg)
12-RAC025 - 55E	25 ~ 32	55	12	24	RCC-025E	CC07	8.0	0.4
16-RAC 32 - 55E	32 ~ 45		16	31	RCC- 32E	CC08	9.7	0.5
20-RAC 43 - 70E	43 ~ 55	70	20	40	RCC- 43E	CC12	12.9	0.7
26-RAC 53 - 70E	53 ~ 70		26	50	RCC- 53E			0.8
26-RAC 70 - 70E	70 ~ 100		26	50	RCC- 70E			1.0
34-RAC 70 - 85E		85				34	64	1.5
42-RAC100 -100E	100 ~ 130	100	42	83	RCC-100E			2.9

★Code No. of RAC25 and RAC32 with CC inserts are changed to RAC25E and RAC32E. ★Insert tips are supplied as an option. P.62 Please refer P.95 for cutting condition.
★For centre through tool coolant type, please add "-C" at the end of Code No. e.g. 26-RAC53-70E-C

RAC Balance-Cut Boring Head



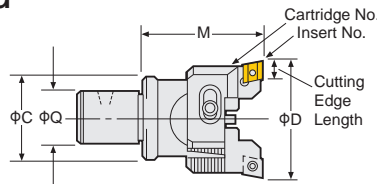
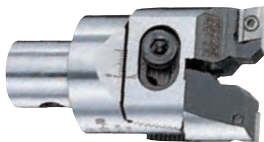
For Heavy Duty Boring of Iron and Cast Iron
CN Insert (Negative type)

P.64

Head Code No.	Boring Range D	Boring Depth M	Coupling Dia Q	C	Cartridge No.	Insert No.	Cutting Edge Length	Weight (Kg)
20-RAC 43 - 70	43 ~ 55	70	20	40	RCC- 43	CN08	12.9	0.7
26-RAC 53 - 70	53 ~ 70		26	50	RCC- 53			0.8
26-RAC 70 - 70	70 ~ 100	26	50	RCC- 70	1.0			
34-RAC 70 - 85					85	34	64	1.5
42-RAC100 -100	100 ~ 130	100	42	83	RCC-100			2.9

★Insert tips are supplied as an option. P.64 Please refer P.95 for cutting condition.
★For centre through tool coolant type, please add "-C" at the end of Code No. e.g. 26-RAC53-70-C

RAC-A Balance-Cut Boring Head



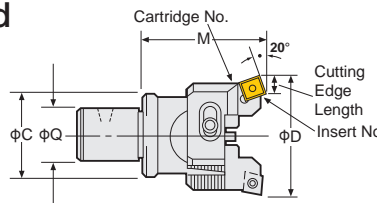
For Aluminum

P.66

Head Code No.	Boring Range D	Boring Depth M	Coupling Dia Q	C	Cartridge No.	Insert No.	Cutting Edge Length	Weight (Kg)
12-RAC 25 - 55A	25 ~ 32	55	12	24	RAC- 25A	AEG12	9.5	0.4
16-RAC 32 - 55A	32 ~ 45		16	31	RAC- 32A	0.5		
20-RAC 43 - 70A	43 ~ 55	70	20	40	RAC- 43A	AEG16	15.875	0.7
26-RAC 53 - 70A	53 ~ 70		26	50	RAC- 53A			0.8
26-RAC 70 - 70A	70 ~ 100		26	50	RAC- 70A			1.0
34-RAC 70 - 85A		85				34	64	1.5
42-RAC100 -100A	100 ~ 130	100	42	83	RAC-100A			2.9

★Insert tips are supplied as an option. P.66 Please refer P.95 for cutting condition.
★For centre through tool coolant type, please add "-C" at the end of Code No. e.g. 26-RAC53-70A-C

RAC-K Balance-Cut Boring Head



For Through Hole and Multi Sheets

P.68

Head Code No.	Boring Range D	Boring Depth M	Coupling Dia Q	C	Cartridge No.	Insert No.	Cutting Edge Length	Weight (Kg)
12-RAC 25 - 55K	25 ~ 32	55	12	24	RAC- 25K	SC09	7.4	0.4
16-RAC 32 - 55K	32 ~ 45		16	31	RAC- 32K	0.5		
20-RAC 43 - 70K	43 ~ 55	70	20	40	RAC- 43K	SC12	11.9	0.7
26-RAC 53 - 70K	53 ~ 70		26	50	RAC- 53K			0.8
26-RAC 70 - 70K	70 ~ 100		26	50	RAC- 70K			1.0
34-RAC 70 - 85K		85				34	64	1.5
42-RAC100 -100K	100 ~ 130	100	42	83	RAC-100K			2.9

★Insert tips are supplied as an option. P.68 Please refer P.95 for cutting condition.
★For centre through tool coolant type, please add "-C" at the end of Code No. e.g. 26-RAC53-70K-C

BT

CARTRIDGE for RAC BORING HEAD

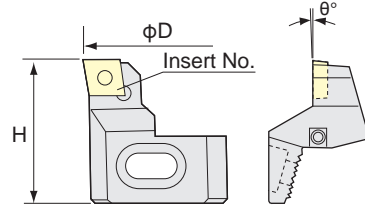


B1

RAC Base () is common for all types of cartridges.
Please select suitable cartridge and insert tip for your application such as material and machining.

For Steel, Stainless Steel and Cast Iron
CC Insert (Positive type)

S.RCC-E Cartridge

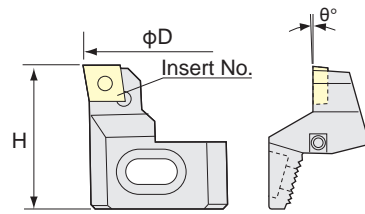


Set Code No.	Boring Range D	H	θ	Insert Code No.	
				Steel, Stainless Steel	Cast Iron
S.RCC- 25E	25 ~ 32	41	0°	CC08-C (AC630M)	CC08-C (AC410K)
		38		CC07-C (AC630M)	CC07-C (AC410K)
- 32E	32 ~ 45	41		CC08-C (AC630M)	CC08-C (AC410K)
		46			
- 53E	43 ~ 55	50	+3°	CC12-C (AC630M)	CC12-C (AC410K)
- 70E	53 ~ 70	55			
- 100E	70 ~ 100	57			
	100 ~ 130	57			

★Code No. of RAC25 and RAC32 with CC inserts are changed to RAC25E and RAC32E.
★Insert tips are supplied as an option. P.62 Please refer P.95 for cutting condition.
★Please order set of cartridges. e.g S.RCC-70E
★2 stepped balance cut with H=0.3 cartridge is also available. e.g. S.RCC-70E (0.3)

For Heavy Duty Boring of Iron and Cast Iron
CN Insert (Negative type)

S.RCC Cartridge

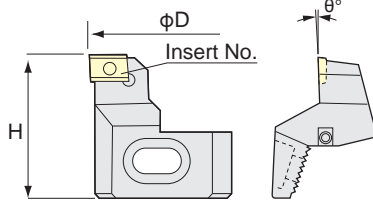


Set Code No.	D	H	θ	Insert Code No.	
				Iron and Cast Iron	
S.RCC- 43	43 ~ 55	46	-3°	CN08	
- 53	53 ~ 70	50			
- 70	70 ~ 100	55			
- 100	100 ~ 130	57			

★Insert tips are supplied as an option. P.64 Please refer P.95 for cutting condition.
★Please order set of cartridges. e.g S.RCC-70
★When CN08 insert (CN00120400) in the market is used, please use the eccentric bolt type cartridge (S.RCC-00Q) P.92. Nikken CN08-08 insert can be used on the eccentric bolt type cartridge.

For Aluminum

S.RCC-A Cartridge

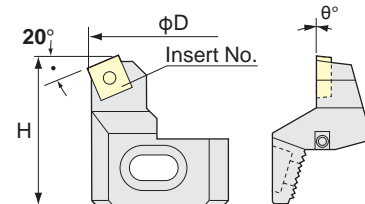


Set Code No.	D	H	θ	Insert Code No.	
				For Aluminum	
S.RCC- 25A	25 ~ 32	38	+6°	AEG12	
- 32A	32 ~ 45	41			
- 43A	43 ~ 55	46		AEG16	
- 53A	53 ~ 70	50			
- 70A	70 ~ 100	55			
- 100A	100 ~ 130	57			

★Insert tips are supplied as an option. P.66 Please refer P.95 for cutting condition.
★Please order set of cartridges. e.g S.RCC-70A
★2 stepped balance cut with H=0.3 cartridge is also available. e.g. S.RCC-70A (0.3)
★S.RCC-A cartridge can be used for the bottom face finishing of iron and cast iron.

For Through Hole and Multi Sheets

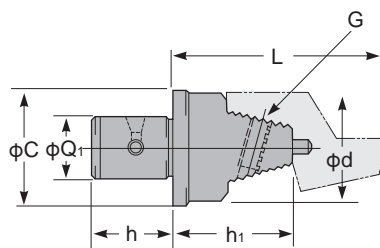
S.RCC-K Cartridge



Set Code No.	D	H	θ	Insert Code No.	
				Steel, Stainless Steel	Cast Iron
S.RCC- 25K	25 ~ 32	41	0°	SC09-C (AC630M)	SC09-C (AC410K)
- 32K	32 ~ 45	41		SC12-C (AC630M)	SC12-C (AC410K)
- 43K	43 ~ 55	46			
- 53K	53 ~ 70	50			
- 70K	70 ~ 100	55			
- 100K	100 ~ 130	57			

★Insert tips are supplied as an option. P.68 Please refer P.95 for cutting condition.
★Please order set of cartridges. e.g S.RCC-70E

Dimension of RAC Base



Code No.	Boring Range D	h	h ₁	C	G	d
12-RAC025- 55B						
16-RAC 32- 55B	32~45	22	31	31	M6	30
20-RAC 43- 70B						
26-RAC 53- 70B	53~70	24	42	40	M8	35
26-RAC 70- 70B						
34-RAC 70- 85B	70~100	28	40	50	M8	45
42-RAC100-100B						
	100~130	36	53	64	M8	60
	100~130	42	66	83	M8	70

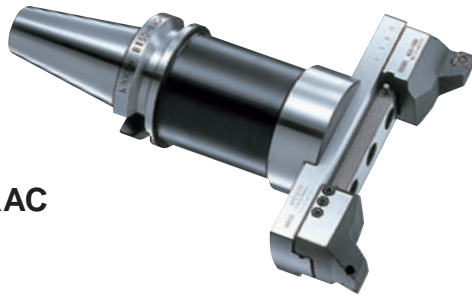
★Dimension "L" is "58mm" in combination of RCC-25K and 12-RAC25-55B.
★For centre through tool coolant type except 26-RAC70-70B, please add "-C" at the end of Code No. e.g. 34-RAC70-85B-C

BALANCE-CUT RAC BORING ARBOR for LARGE DIA.

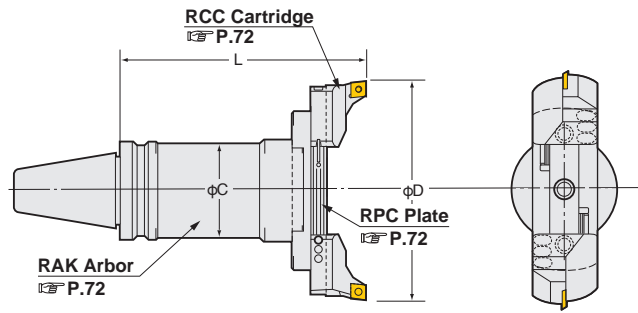
NIKKEN

For Roughing

- With the screws for slight adjustment
- Boring Dia. : $\phi 130 \sim \phi 580\text{mm}$



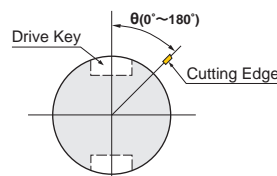
RAC



Boring Dia. : $\phi 130 \sim 580\text{mm}$

TAPE	Code.No	D	L	C	RAK Arbor Code No.	RPC Plate No.	RCC Cartridge No.	Weight (Kg)				
		MIN.~MAX.										
No.40	BT40-RAC130-205	130~180	205	61	BT40-RAK-130	RPC-130		7.0				
	(IT40)-RAC180-205	180~230						8.0				
No.50	BT50-RAC130-185	130~180	185	90	BT50-RAK-110A	RPC-130	For Heavy Duty Boring of Iron and Cast Iron	9.8				
	(IT50)-235		235					-160A	12.5			
	-285		285					-210A	15.2			
	-335		335					-260A	17.9			
	-385		385					-310A	20.6			
	-435		435					-360A	23.3			
	-485		485					-410A	26.0			
	-RAC180-185		185					-RAK-110A	10.4			
	-235	235	-160A		13.1							
	-285	285	-210A		15.8							
	-335	335	-260A		18.5							
	-385	385	-310A		21.2							
	-435	435	-360A		23.9							
	-485	485	-410A		26.6							
	-RAC230-185	185	-RAK-110A		11.1							
	-235	235	-160A		13.8							
	-285	285	-210A		16.5							
	-335	335	-260A		19.2							
	-385	385	-310A		21.9							
	-435	435	-360A		24.6							
	-485	485	-410A		27.3							
	-RAC280-185	185	-RAK-110A		11.7							
	-235	235	-160A		14.4							
	-285	285	-210A		17.1							
	-335	335	-260A		19.8							
	-385	385	-310A		22.5							
	-435	435	-360A		25.2							
	-485	485	-410A		27.9							
	-RAC330-210*	330~380	210 (220*)		98	BT50-RAK330-125 IT50-RAK330-135		RPC-230	RPC-280	RCC-130 x2 Insert Tip CN08	16.0	
	-RAC380-210*	380~430									RPC-330	17.0
	-RAC430-210*	430~480									-380	18.0
	-RAC480-210*	480~530									-430	19.0
-RAC530-210*	530~580	-480		19.0								
		-530		20.0								

- ★The Code No. on above table are the boring arbors with **RCC-130** cartridge (Insert tip: **CN08**) the Heavy Duty Boring of Iron and Cast Iron. Please refer **P.95** for cutting condition.
- ★Boring arbor with cartridges & insert for Steel, Stainless Steel and Cast Iron (E), for Aluminum (A) and for Through Hole & Multi Sheets (K) are available. Please refer **P.72** for cartridges. e.g. **BT50-RAC130-185E**
- ★Please refer **P.72** for **RAK** arbor and **RPC** plate.
- ★Arbor, plate and cartridges are delivered in separate packages.
- ★Please check the interference of the arbor with your M/C not to occur the interference in the tool magazine.
- ★The location of the cutting edge is same as the drive key for standard. The different location is available, please specify θ . e.g. **BT50-RAC180-235 (90°)**
- ★For centre through tool coolant type, please add "-C" at the end of Code No. e.g. **BT50-RAC130-185-C**
- ★The boring arbors marked * with **IT50**, L (gauge length) is 220. e.g. **IT50-RAC330-220**



View from Cutting Edge

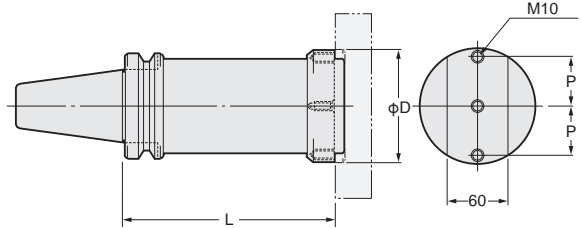
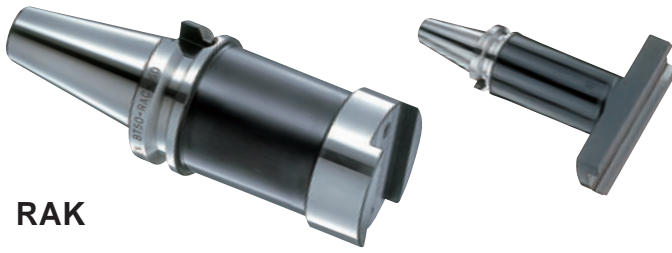


High Pressure Coolant Through Tool

MODULAR TYPE ARBOR



BALANCE CUT RAK BORING ARBOR for LARGE DIA. <RAK Arbor>



RAK

Code No.	Boring Range	L	D	P	Weight (Kg)	Applicable RPC Plate	Hex. Socket bolt
BT40 (IT40) -RAK-130	φ130~330	130	102	35	4.9	RPC-130, 180	M1035
BT50 -RAK-110A		110			7.2	RPC-130, 180, 230, 280	
(IT50) -RAK-160A		160			9.9		
-RAK-210A		210			12.6		
-RAK-260A		260			15.3		
-RAK-310A		310			18.0		
-RAK-360A		360			20.7		
-RAK-410A		410			23.4		
-RAK330-125*	φ330~580	125	240	100	12.0	RPC-330, 380, 430, 480, 530	M1045

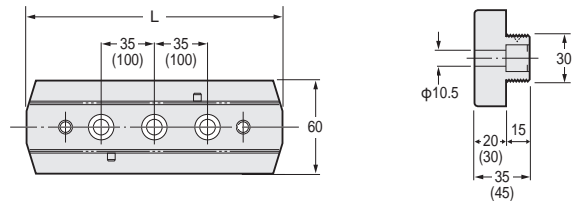
★The location of the cutting edge is same as the drive key for standard. The different location is available, please specify θ. e.g. BT50-RAK-160A (90°)

★For centre through tool coolant type, please add "-C" at the end of Code No. e.g. BT50-RAK-160A-C 2 set of coolant nozzles are standard accessory.

★IT40-RAK-130 is available. ★*: In case of IT50, IT50-RAK-330-135 is standard gauge length.



BALANCE CUT PLATE for LARGE DIA. <RPC Plate>



Dimensions in () are for RPC-330, 380, 430, 480 and 530.

Code No.	Boring Range	L	Weight (Kg)	Code No.	Boring Range	L	Weight (Kg)	Code No.	Boring Range	L	Weight (Kg)
RPC-130	φ130~180	118	1.4	RPC-330	φ330~380	316	5.3	RPC-530	φ530~580	516	8.7
-180	φ180~230	166	2.0	-380	φ380~430	366	6.1				
-230	φ230~280	216	2.7	-430	φ430~480	416	7.0				
-280	φ280~330	266	3.3	-480	φ480~530	466	7.9				

Accessories for Balance-Cut RAC

Steel, Stainless Steel and Cast Iron
RCC-130
(CN08)

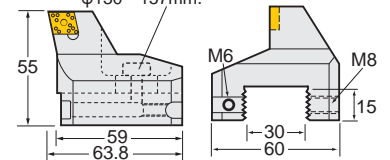
Heavy Duty Boring of Iron and Cast Iron
RCC-130E
(CC12)

For aluminum
RCC-130A
(AEG16)

For Through Hole and Multi Sheets
RCC-130K
(SC12)



Cartridge Lock Bolt
Please remove the bolt when using RAC-130 type for φ130~157mm.



Weight : 0.6Kg

Accessories	Insert Tip	Clamp Bolt	Adjust Screw	Adjust Wrench	Wrench for Insert	Set Screw (M8)	L-Wrench for M815 Bolt	Hex Socket Bolt	Applicable RPC Plate
Code No.	*	CSM-70	M540	M3	20S	M815	M4	M625	RPC-130, 180, 230, 280, 330, 380, 430, 480, 530

★*: The insert tip is RCC-130: CN08 (P.64), RCC-130E: CC12 (P.62), RCC-130A: AEG16 (P.66), RCC-130K: SC12 (P.68) Please refer P.95 for cutting condition.

★There are two different types clamping system. One is eccentric system, the other is screw on system. Above parts are for screw on system.

★Code No. RCC-130 indicates a single cartridge. When ordering a pair cartridge, please appoint to us Code No. S.RCC-130.

★The Code No. of the cartridges for 2 stepped balance cut is SRCC-130-0.3

ZMAC BORING ARBOR (ZMAC)



Boring for Finishing



ZMAC

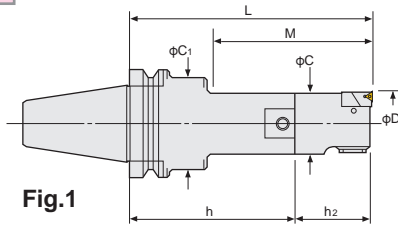


Fig.1

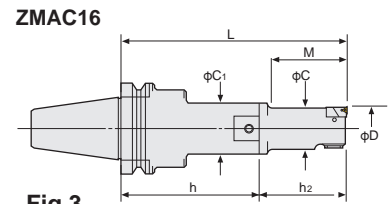


Fig.3

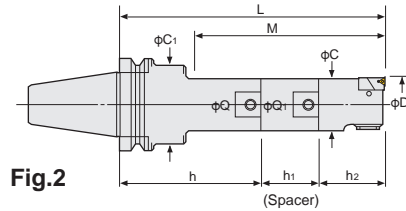


Fig.2

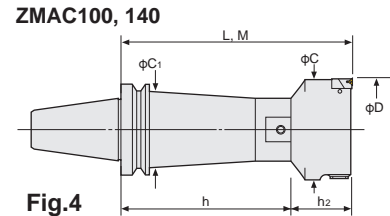


Fig.4

Code No. of the insert tip are shown.

TAPER	Code No.	Boring Range D	Boring Depth M	C	C1	Shank Code No.	Extension Spacer Code No.	P.98		Weight (kg)	Fig.			
								Head No.	Insert No.					
						BT No.-Q-h	Q-Q1-h1	Q- Min.D -h2						
No.40	BT40-ZMAC16 -125	15.9~20.2	38	15	24	BT40-Q12- 80	—	12-ZMAC16-45	3MP-C,B	1.9	3			
	(IT40) -135		48					12-ZMAC16-55						
	-ZMAC20 -120	19.8~25.2	45	19	30	-Q 9- 80	—	9-ZMAC20-40		1.9	1			
	-135		67							—		2.0	2	
	-150		75											
	-ZMAC25 -120	24.8~32.2	52	24	35	-Q12- 80	—	12-ZMAC25-40		2.0	1			
	-150		90							—		2.1	2	
	-165		97											
	-ZMAC32 -150	31.8~42.2	77	31	42	-Q16- 95	—	16-ZMAC32-55		2.5	4MP-C,B	1		
	-180		110							—			2.7	2
	-195		122											
	-ZMAC42 -150	41.8~55.2	97	40	50	-Q20- 80	—	20-ZMAC42-70		3.0	6MP-C,B	1		
	-180		130							—			3.2	2
	-210		157											
	-ZMAC55 -165	54.8~70.2	135	53	50	-Q26- 95	—	26-ZMAC55-70		3.5	1			
	-210		180							—		4.6	2	
	-225		195											
	-ZMAC70 -165	69.8~85.2	165	67	64	-Q34- 95	—	34-ZMAC70-70		5.4	1			
-180	180		—						5.8	2				
-225	225													
-ZMAC85 -195	84.8~100.2	195	83	62	-Q42- 95	—	42-ZMAC85-100	6.8	2	9.0	1			

★MIN. dial readout : ZMAC25 & smaller is 0.02mm on diameter. ZMAC32 and larger are 0.01mm on diameter.

★“C” grade (Coated) insert for Steel, Stainless & Cast Iron is supplied as Standard with the head (Smooth boring & Long tool-life) . Please refer P.96 for cutting condition.

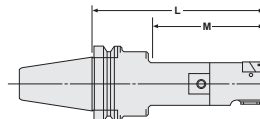
We would recommend “B” grade (CBN) insert for Hardened Steel & High Speed boring of Cast Iron.

★Please refer P.85 for Shank & Spacer, and P.77, P.78 for Head.

★For Centre Through Tool Coolant type, please add “C” at the end of Code No. e.g. BT40-ZMAC55-165C.

★For BT30, modular connection system is applied. Please refer P.85 for Base Holder.

★When L length is required longer than standard, please specify boring depth M.



Boring Arbor with Extension Spacer

ZMAC for Multi-Stage Boring Bar

Please contact us for the special boring bar.



High Pressure Coolant Through Tool

ZMAC BORING ARBOR (ZMAC)



■ With ZMAC \times Boring Head
Please add "AA" at the end of Code No.
e.g. BT40-ZMAC42-150AA



ZMAC \times

Diameter can be adjusted easily and quickly by new handle with wrench.



Unlock

Adjust diameter

Lock

Code No. of the insert tip are shown.

TAPER	Code No.	Boring Range D	Boring Depth M	C	C ₁	Shank Code No.	Extension Spacer Code No.	P.98		Weight (kg)	Fig.	
								Head No.	Insert No.			
						BT No.-Q-h	Q-Q ₁ -h ₁	Q- Min.D -h ₂				
No.50	BT50-ZMAC16 -140	15.9~20.2	38	15	24	BT50-Q12- 95	—	12-ZMAC16-45	3MP-C,B	4.7	3	
	(IT50) -150		48					12-ZMAC16-55				
	-ZMAC20 -150	19.8~25.2	45	19	40	-Q 9-110	SP9-9-30	9-ZMAC20-40	4.8	4.8	1	
	-165		67			-Q 9-125N						
	-180		75			-Q 9-110						
	-ZMAC25 -135	24.8~32.2	52	24	44	-Q12- 95	—	12-ZMAC25-40	4.8	4.8	1	
	-165		90			-Q12-125						
	-180		97			-Q12- 95						
	-ZMAC32 -180	31.8~42.2	77	31	50	-Q16-125N	—	16-ZMAC32-55	4MP-C,B	5.5	5.6	1
	-210		110			-Q16-155						
	-225		122			-Q16-125N						
	-ZMAC42 -180	41.8~55.2	97	40	60	-Q20-110	—	20-ZMAC42-70	6MP-C,B	6.0	6.0	1
	-195		130			-Q20-125						
	-225		142			-Q20-110						
	-240		157			SP20-20-45						
	-ZMAC55 -210	54.8~70.2	117	53	65	-Q26-140	—	26-ZMAC55-70	7.5	7.6	8.1	1
	-240		182			-Q26-170N						
	-270		177			-Q26-140						
	-ZMAC70 -240	69.8~85.2	190	67	80	-Q34-170	—	34-ZMAC70-70	10.0	10.6	11.5	1
	-270		220			-Q34-200						
	-300		250			-Q34-170						
	-ZMAC85 -225	84.8~100.2	182	83	83	-Q42-125	—	42-ZMAC85-100	12.5	15.0	16.0	1
	-290		247			-Q42-190						
	-315		272			-Q42-125						
	-ZMAC100-225	99.5~140.5	225	95	98	-Q42-125	—	42-ZMAC100-100	12.4	15.1	17.8	4
	-290		290			-Q42-190						
	-325		325			-Q42-225A						
	-375		375			-Q42-275A						
-425	425		-Q42-325A									
-ZMAC140-225	139.5~180.5	225	135	98	-Q42-125	—	42-ZMAC140-100	13.8	16.5	19.2	4	
-290		290			-Q42-190							
-325		325			-Q42-225A							
-375		375			-Q42-275A							
-425		425			-Q42-325A							

★MIN. dial readout : ZMAC25 & smaller is 0.02mm on diameter. ZMAC32 and larger are 0.01mm on diameter.
 ★When L length is required longer than standard, please specify boring depth M. ★For Centre Through Tool Coolant type, add "C" at the end of Code No. e.g. BT50-ZMAC55-210C.
 ★"C" grade (Coated) insert for Steel, Stainless&Cast Iron is supplied as Standard with the head (Smooth boring & Long tool-life). P.98
 We would recommend "B" grade (CBN) insert for Hardened Steel & High Speed boring of Cast Iron. Please refer P.96 for cutting condition.
 ★Please refer P.85 for Shank & Spacer, and P.77, P.78 for Head.

BT

ZMAC BORING ARBOR (ZMAC-R)



Boring for Semi-Finishing—ZMAC-R



ZMAC-R

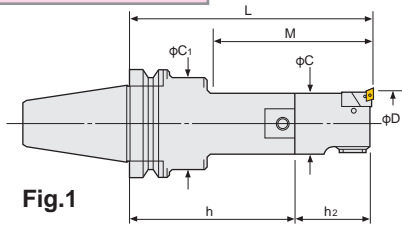


Fig.1

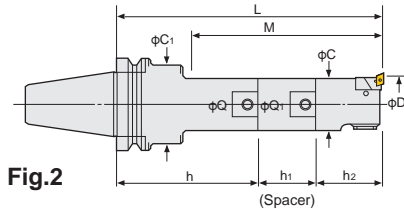


Fig.2

ZMAC100, 140

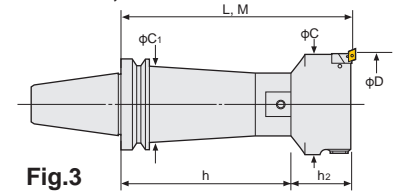







Fig.3

Code No. of the insert tip  are shown.


TAPER	Code No.	Boring Range D	Boring Depth M	C	C ₁	Shank Code No.	Extension Spacer Code No.	P.76		Weight (kg)	Fig.	
								Head No.	Insert No.			
						BT No.-Q-h	Q-Q1-h1	Q- Min.D -h2				
No.40	BT40-ZMAC32R -150	31.8~42.2	77	31	42	BT40-Q16- 95	—	16-ZMAC32R-55	CC06-C	2.5	1	
	(IT40) -180		110			-Q16-125				2.7		
	-195		122			-Q16- 95				2.7		
			41.8~55.2	97	40	50	-Q20- 80	—	20-ZMAC42R-70	CC06-C	3.0	1
	-180	130		-Q20-110			3.2					
	-210	157		-Q20- 80			3.5					
			54.8~70.2	135	53	50	-Q26- 95	—	26-ZMAC55R-70	CC06-C	3.9	1
	-180	180		-Q26-140			4.6					
	-225	195		-Q26- 95			4.6					
			69.8~85.2	165	67	64	-Q34- 95	—	34-ZMAC70R-70	CC08-C	5.4	1
	-180	180		-Q34-110			5.8					
	-225	225		-Q34- 95			6.8					
		84.8~100.2	195	83	62	-Q42- 95	—	42-ZMAC85R-100		9.0	1	

★MIN. dial readout : ZMAC25 & smaller is 0.02mm on diameter. ZMAC32 and larger are 0.01mm on diameter.

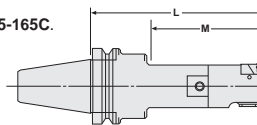
★“C” grade (Coated) insert for Steel, Stainless & Cast Iron is supplied as Standard with the head (Smooth boring & Long tool-life).  P.76 Please refer  P.96 for cutting condition. We would recommend “B” grade (CBN) insert for Hardened Steel & High Speed boring of Cast Iron.

★Please refer  P.85 for Shank & Spacer, and  P.77, P.78 for Head.

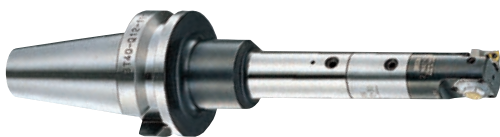
★For Centre Through Tool Coolant type, please add “C” at the end of Code No. e.g. BT40-ZMAC55-165C.

★For BT30, modular connection system is applied. Please refer  P.85 for Base Holder.

★When L length is required longer than standard, please specify boring depth M.

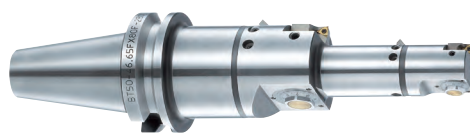


Boring Arbor with Extension Spacer



ZMAC for Multi-Stage Boring Bar

Please contact us for the special boring bar.



High Pressure Coolant Through Tool

ZMAC BORING ARBOR (ZMAC-R)



Insert Tip for ZMAC-R

● : best ○ : good

Material	Steel		●		
	Stainless Steel		●		
	Cast Iron		○	●	
Material	Aluminium				
	High Speed finish for Cast Iron				
	Hardened Steel				
	High Speed finish for Aluminium				
		Coated Carbide M	Coated Carbide K		
		Grade	C		
		Material	AC630M	AC410K	
Applicable Arbor	Dimension	Code No.	Nose R	AC630M	AC410K
ZMAC32R, ZMAC42R, ZMAC55R		CC06-○4	0.4	●	●
		CC06-○8	0.8	●	●
		CC08-○4	0.4	●	●
ZMAC70R, ZMAC85R		CC08-○4	0.4	●	●
		CC08-○8	0.8	●	●
		CC12-○4	0.4	●	●
ZMAC100R, ZMAC140R		CC12-○4	0.4	●	●
		CC12-○8	0.8	●	●

Please add the grade indication into ○, and add the insert tip material indication at the end off the Code No. e.g. CC12-C8 (AC630M)

There is the CBN insert tip which both corners can be used. Please refer P.98 for ISO code of the insert tip.



Code No. of the insert tip are shown.

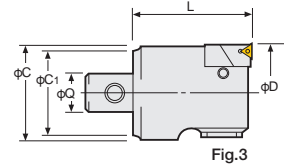
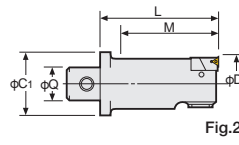
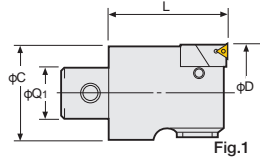
TAPER	Code No.	Boring Range D	Boring Depth M	C	C ₁	Shank Code No.	Extension Spacer Code No.	P.76		Weight (kg)	Fig.							
								Head No.	Insert No.									
								BT No.-Q-h	Q-Q ₁ -h ₁			Q- Min.D -h ₂						
No.50	BT50-ZMAC32R -180	31.8~42.2	77	31	50	BT50-Q16-125N	—	16-ZMAC32R-55	CC06-C	5.5	1							
	(IT50) -210		110			-Q16-155				5.6								
	-225		122			-Q16-125N				5.7								
	-ZMAC42R -180	41.8~55.2	97	40	60	-Q20-110	—	20-ZMAC42R-70	CC06-C	6.0	1							
			-195			130				-Q20-125		6.0						
			-225			142				-Q20-110		6.4						
			-240			157				SP20-20-45	6.5							
			-ZMAC55R -210			54.8~70.2				117	53	65	-Q26-140	—	26-ZMAC55R-70	CC06-C	7.5	1
										-240			182				-Q26-170N	
	-270	177		SP20-20-60	8.1													
	-ZMAC70R -240	69.8~85.2	190	67	80	-Q34-170	—	34-ZMAC70R-70	CC08-C	10.0	1							
			-270			220				-Q34-200		10.6						
			-300			250				-Q34-170	11.5							
			-ZMAC85R -225			182				83	83	-Q42-125	—	42-ZMAC85R-100	CC08-C	12.5	1	
	-290	247	-Q42-190	15.0														
	-315	272	-Q42-125	16.0														
	-ZMAC100R-225	99.5~140.5	225	95	98	-Q42-125	—	42-ZMAC100R-100	CC12-C	12.4	3							
			-290			290				-Q42-190		15.1						
			-325			325				-Q42-225A		17.8						
			-375			375				-Q42-275A		20.5						
			-425			425				-Q42-325A		23.2						
	-ZMAC140R-225	139.5~180.5	225	135	98	-Q42-125	—	42-ZMAC140R-100	CC12-C	13.8	3							
			-290			290				-Q42-190		16.5						
			-325			325				-Q42-225A		19.2						
-375			375			-Q42-275A				21.9								
-425			425			-Q42-325A				24.6								

★MIN. dial readout : ZMAC25 & smaller is 0.02mm on diameter. ZMAC32 and larger are 0.01mm on diameter.
 ★When L length is required longer than standard, please specify boring depth M. ★For Centre Through Tool Coolant type, add "C" at the end of Code No. e.g. BT50-ZMAC55-210C.
 ★"C" grade (Coated) insert for Steel, Stainless&Cast Iron is supplied as Standard with the head (Smooth boring & Long tool-life). P.76
 We would recommend "B" grade (CBN) insert for Hardened Steel & High Speed boring of Cast Iron. Please refer P.96 for cutting condition.
 ★Please refer P.85 for Shank & Spacer, and P.77, P.78 for Head.

MODULAR TYPE ZMAC BORING HEAD

NIKKEN

ZMAC Triangular Insert type head





Head No.	Boring Range D	Boring Depth M	Coupling Dia. Q	Remarks					Weight (Kg)
				C	C1	Unit No.	Insert No.	Fig.	
12-ZMAC 16- 45	15.9~20.2	38	12	15	24	M 2HZ- 16	3MP-C,B	2	0.4
12-ZMAC 16- 55		48							0.4
9-ZMAC 20- 40	19.8~25.2	40	9	19	24	M 2HZ- 20	4MP-C,B	1	0.4
12-ZMAC 25- 40	24.8~32.2		12			M 3HZ- 25			0.5
16-ZMAC 32- 55	31.8~42.2	55	16	31	-	M 4HZ- 32	6MP-C,B	1	0.7
20-ZMAC 42- 70	41.8~55.2	20	40	M 5HZ- 42		1.1			
26-ZMAC 55- 70	54.8~70.2	70	26	53	-	M 5HZ- 55	6MP-C,B	1	1.2
34-ZMAC 70- 70	69.8~85.2		34	67		M 7HZ- 70			2.0
42-ZMAC 85-100	84.8~100.2	100	42	83	-	M10HZ- 85	6MP-C,B	1	4.3
42-ZMAC100-100	99.5~140.5			95		83			M10HZ-100
42-ZMAC140-100	139.5~180.5			135	83	M10HZ-140		3	6.3

★MIN. dial read out: ZMAC25 and smaller is 0.02mm on dia.

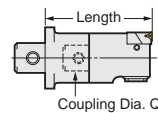
ZMAC32 and larger is 0.01mm on dia.

★The above boring ranges are based on heads with Nose/R 0.2 insert.

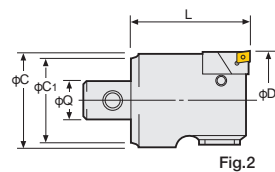
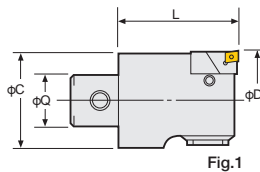
★“C” grade (Coated) insert for Steel, Stainless & Cast Iron is supplied as Standard with the head (Smooth boring & Long tool-life) .  Please refer  P.96 for cutting condition. We would recommend “B” grade (CBN) insert for Hardened Steel & High Speed boring of Cast Iron.

★For Centre Through Tool Coolant type, please add “C” at the end of Code No. e.g. 26-ZMAC55-70C

★Code No. of the set with SP26 stepped spacer is Q26-Coupling Dia.-ZMAC○-Length e.g. Q26-20-ZMAC42-100





ZMAC- R Rhomboid Insert type head



Head No.	Boring Range D	Boring Depth M	Coupling Dia. Q	Remarks					Weight (Kg)
				C	C1	Unit No.	Insert No.	Fig.	
16-ZMAC 32R - 55	31.8~42.2	55	16	31	-	M 4HZ- 32R	CC06-C	1	0.7
20-ZMAC 42R - 70	41.8~55.2					20			40
26-ZMAC 55R - 70	54.8~70.2	70	26	53	-	M 5HZ- 55R	CC08-C	1	1.2
34-ZMAC 70R - 70	69.8~85.2					34			67
42-ZMAC 85R -100	84.8~100.2	100	42	83	-	M10HZ- 85R	CC08-C	1	4.3
42-ZMAC 100R -100	99.5~140.5			95		83			M10HZ-100R
42-ZMAC 140R -100	139.5~180.5			135	83	M10HZ-140R		2	6.3

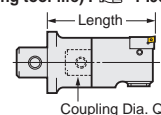
★MIN. dial read out: ZMAC25 and smaller is 0.02mm on dia.

ZMAC32 and larger is 0.01mm on dia.

★“C” grade (Coated) insert for Steel, Stainless & Cast Iron is supplied as Standard with the head (Smooth boring & Long tool-life) .  Please refer  P.96 for cutting condition.

★For Centre Through Tool Coolant type, please add “C” at the end of Code No. e.g. 26-ZMAC55R-70C

★Code No. of the set with SP26 stepped spacer is Q26-Coupling Dia.-ZMAC○-Length e.g. Q26-20-ZMAC42R-100

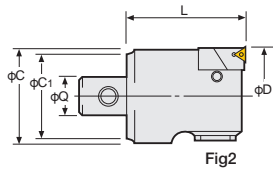
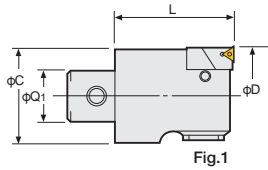


MODULAR TYPE ZMAC& BORING HEAD



For High Speed/Deep Hole Boring

ZMAC& Triangular Insert type head



Head No.	Boring Range D	Boring Depth M	Coupling Dia. Q	Remarks					Weight (Kg)			
				C	C1	Unit No.	Insert No.	Fig.				
12-ZMAC 25- 40AA	24.8~32.2	40	12	24	-	M 3HZ- 25	3MP-C,B	1	0.4			
16-ZMAC 32- 55AA	31.8~42.2	55	16	31		M 4HZ- 32	4MP-C,B		0.5			
20-ZMAC 42- 70AA	41.8~55.2	70	20	40		M 5HZ- 42	6MP-C,B		1	0.8		
26-ZMAC 55- 70AA	54.8~70.2		26	53		M 5HZ- 55				0.7		
34-ZMAC 70- 70AA	69.8~85.2		34	67		M 7HZ- 70				1.1		
42-ZMAC 85-100AA	84.8~100.2	100	42	83		83				M10HZ- 85	2	2.3
42-ZMAC100-100AA	99.5~140.5			95						M10HZ-100		2.8
42-ZMAC140-100AA	139.5~180.5			135	M10HZ-140	3.1						

★MIN. dial read out: ZMAC25 and smaller is 0.02mm on dia.

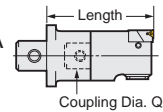
ZMAC32 and larger is 0.01mm on dia.

★The above boring ranges are based on heads with Nose/R 0.2 insert.

★“C” grade (Coated) insert for Steel, Stainless & Cast Iron is supplied as Standard with the head (Smooth boring & Long tool-life). P.98 Please refer P.96 for cutting condition. We would recommend “B” grade (CBN) insert for Hardened Steel & High Speed boring of Cast Iron.

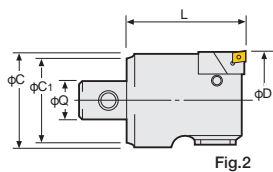
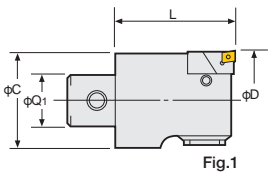
★Centre Through Tool Coolant function is available as standard.

★Code No. of the set with SP26 stepped spacer is Q26-Coupling Dia.-ZMAC○-Length AA e.g. Q26-20-ZMAC42-100AA



For High Speed/Deep Hole Boring

ZMAC& - R Rhomboid Insert type head



Head No.	Boring Range D	Boring Depth M	Coupling Dia. Q	Remarks					Weight (Kg)			
				C	C1	Unit No.	Insert No.	Fig.				
16-ZMAC 32R - 55AA	31.8~42.2	55	16	31	-	M 4HZ- 32R	CC06-C	1	0.5			
20-ZMAC 42R - 70AA	41.8~55.2	70	20	40		M 5HZ- 42R			0.8			
26-ZMAC 55R - 70AA	54.8~70.2		26	53		M 5HZ- 55R			0.7			
34-ZMAC 70R - 70AA	69.8~85.2		34	67		M 7HZ- 70R			1.1			
42-ZMAC 85R -100AA	84.8~100.2	100	42	83		83			M10HZ- 85R	CC08-C	2	2.3
42-ZMAC 100R -100AA	99.5~140.5			95					M10HZ-100R			2.8
42-ZMAC 140R -100AA	139.5~180.5			135		M10HZ-140R			3.1			

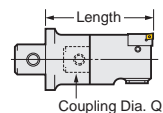
★MIN. dial read out: ZMAC25 and smaller is 0.02mm on dia.

ZMAC32 and larger is 0.01mm on dia.

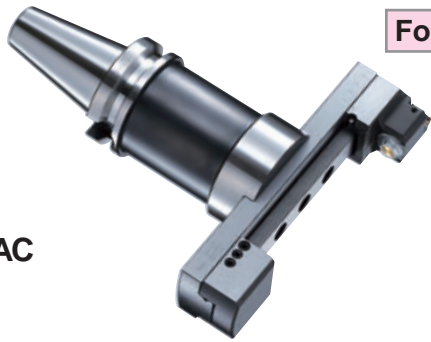
★“C” grade (Coated) insert for Steel, Stainless & Cast Iron is supplied as Standard with the head (Smooth boring & Long tool-life). P.98 Please refer P.96 for cutting condition. We would recommend “B” grade (CBN) insert for Hardened Steel & High Speed boring of Cast Iron.

★Centre Through Tool Coolant function is available as standard.

★Code No. of the set with SP26 stepped spacer is Q26-Coupling Dia.-ZMAC○-Length AA e.g. Q26-20-ZMAC42R-100AA

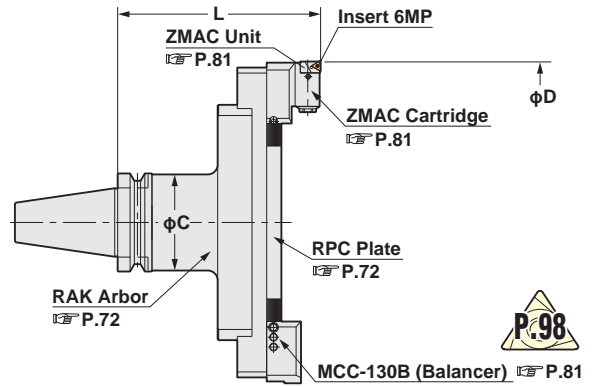


BALANCE-CUT BAC BORING ARBOR for LARGE DIA.



For Finishing

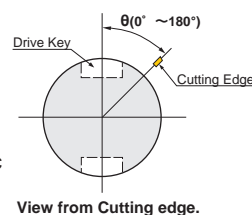
BAC



Boring Dia:φ130~595mm

TAPER	Code.No	D		L	C	RAK Arbor Code No.	PPC Plate No	Cartridge (Balancer)	Weight (Kg)
		MIN.~MAX.							
No.40	BT40-BAC130-205	130~195		205	61	BT40-RAK-130	RPC-130		7.0
	(IT40)-BAC180-205	180~245							8.0
No.50	BT50-BAC130-185	130~195		185	90	BT50-RAK-110A	RPC-130		10.0
	(IT50)-235		235	12.7					
	-285		285	15.4					
	-335		335	18.1					
	-385		385	20.8					
	-435		435	23.5					
	-485		485	26.2					
	-BAC180-185		185	10.6					
	-235	235	13.3						
	-285	285	16.0						
	-335	335	18.7						
	-385	385	21.4						
	-435	435	24.1						
	-485	485	26.8						
	-BAC230-185	185	11.3						
	-235	235	14.0						
	-285	285	16.7						
	-335	335	19.4						
	-385	385	22.1						
	-435	435	24.8						
	-485	485	27.5						
	-BAC280-185	185	11.9						
	-235	235	14.6						
	-285	285	17.3						
	-335	335	20.0						
	-385	385	22.7						
	-435	435	25.4						
	-485	485	28.1						
	-BAC330-210*	330~395	210 (220*)	98	BT50-RAK330-125 IT50-RAK330-135	RPC-330	16.7		
	-BAC380-210*	380~445				-380	17.0		
	-BAC430-210*	430~495				-430	18.0		
	-BAC480-210*	480~545				-480	19.0		
-BAC530-210*	530~595	-530				20.0			

- ★“C” grade (Coated) Inserts are supplied as standard. P.98 Please refer P.96 for cutting condition.
- ★Unit “M5HZ-55” is provided as standard, please refer P.72 for Arbor (RAK) and Plate (RPC).
- ★Arbor, Plate and Cartridge are delivered in separate packages.
- ★When ordering, please let us know machine maker and model no. to avoid the interference with tool magazine of ATC.
- ★The location of cutting edge is same as drive key in standard.
- The different location is available, please specify θ in Code No. e.g. BT50-BAC180-235 (90°)
- ★The boring arbors marked * with IT50, L (gauge length) is 220. e.g. IT50-BAC330-220
- ★For centre through tool coolant type, please add “-C” at the end of Code No. e.g. BT50-BAC130-185-C



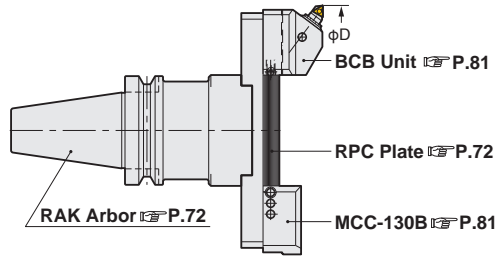
High Pressure Coolant Through Tool

BALANCE-CUT BCB BORING ARBOR for LARGE DIA.



BCB

For Roughing / Finishing



Boring Dia: $\phi 130 \sim 595$ mm

TAPER	Code.No	D		L	C	RAK Arbor Code No.	RPC Plante No	Cartridge (Balancer)	Weight (Kg)					
		MIN.	MAX.											
No.40	BT40-BCB130-215	130	195	215	61	BT40-RAK-130	RPC-130	BCB-130 (MCC-130B) Insert 10MP	7.5					
	(IT40)-BCB180-215	180	245						8.5					
	No.50	BT50-BCB130-195	130	195	195	90	BT50-RAK-110A		RPC-130	10.3				
		(IT50)-245								245	13.0			
		-295								295	15.7			
		-345								345	18.4			
		-395								395	21.1			
		-445								445	23.8			
		-495								495	26.5			
		-BCB180-195								180	195	195	90	BT50-RAK-110A
-245		245						13.6						
-295		295	16.3											
-345		345	19.0											
-395		395	21.7											
-445		445	24.4											
No.50		-495	230	295	195	90	BT50-RAK-110A	RPC-230	27.1					
		-BCB230-195							195	11.6				
		-245							245	14.3				
		-295	295	17.0										
		-345	345	19.7										
	-395	395	22.4											
	-445	445	25.1											
	-495	495	27.8											
	-BCB280-195	280	345	195	90	BT50-RAK-110A	RPC-280	12.2						
	-245							245	14.9					
	-295							295	17.6					
	-345							345	20.3					
-395	395							23.0						
-445	445							25.7						
No.50	-495	330	395	220	98	BT50-RAK330-125 IT50-RAK330-135	RPC-330	28.4						
	-BCB330-220*							16.5						
	-BCB380-220*							380	445	220*	98	BT50-RAK330-125	RPC-380	17.5
	-BCB430-220*							430	495	220*	98	IT50-RAK330-135	RPC-430	18.5
	-BCB480-220*							480	545	220*	98		RPC-480	19.5
-BCB530-220*	530	595	220*	98		RPC-530	20.5							

★10MP-T (Cermet) is supplied as standard. P.98 Please refer P.96 for cutting condition.
 ★MIN. dial readout on dia.: 0.02mm, Sub scale: 0.002mm
 ★The boring arbor marked * with IT50, L (gauge length) is 220. e.g. IT50-BCB330-220.

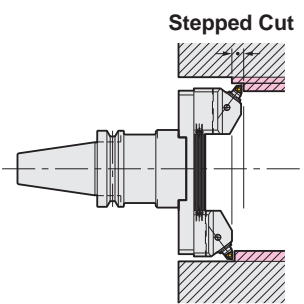
Up to $\phi 800$ is also available. Please contact with us.

Double Cut Style BCB Boring Bar



BCB-W

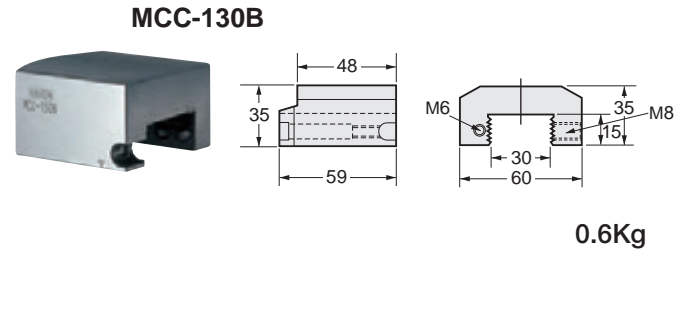
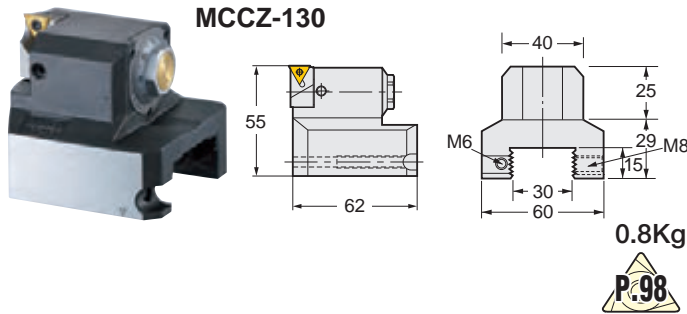
- ★Double cut style can be done with both side of BCB-130 cartridges. Please add "W" at the end of Code No. e.g. BT50-BCB130W-195
- True balance cut can be done to adjust the height by micro adjustment first and then to adjust the diameter by adjust screw.
- Stepped cut can be done to change the height of the cartridges.



Accessories for Balance-Cut BAC

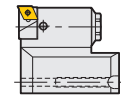
Balance-Cut MAC type cartridge for large dia.

MAC type Balancer for Balance-Cut large dia.



Accessories	ZMAC Unit	Insert Tip	Clamp Bolt	Wrench for Insert	Lock Screw	Adjust Screw	Set Screw (M8)	L-Wrench for M815 Belt	Adjust Wrench	Adjustment Handle	Applicable RPC Plate
Code No.	M5HZ-55	6MP-C	M2577	T8	M366	M540	M815	M4	M3	M5HZL	RPC-130,180,230,280,330,380,430,480,530

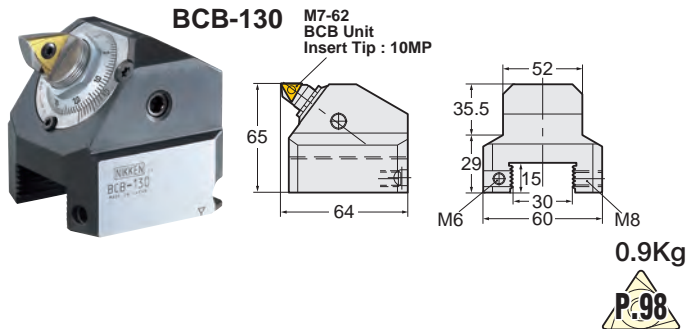
★Please refer P.72 for RPC Plate. ★Set Code No. is **S.MCCZ-130**.
 ★M5HZ-55R with **CC06-C** insert tip is available. Please specify code No. **MCCZ-130R**.
 ★6MP-C insert tip is supplied as standard. P.98 Please refer P.96 for cutting condition.



Accessories for Balance-Cut BCB

Balance-Cut BCB type cartridge for large dia.

MAC type Balancer for Balance-Cut large dia.



Accessories	BCB Unit	Insert Tip	Clamp Bolt	Wrench for Insert	Lock Screw	Adjust Screw	Set Screw (M8)	L-Wrench for M815 Belt	Adjust Wrench	Adjustment Handle	Applicable RPC Plate
Code No.	M7-62	10MP-T	M67	20S	B357, B367	M540	M815	M4	M3	M397	RPC-130,180,230,280,330,380,430,480,530

★Please refer P.72 for RPC Plate. ★Set Code No. is **S.BCB-130**.
 ★10MP-T insert tip is supplied as standard. P.98 Please refer P.96 for cutting condition.

SPECIAL DESIGNED BORING ARBOR

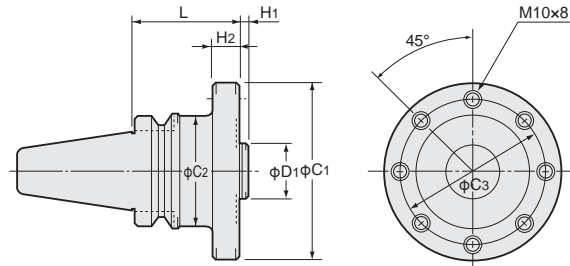
NIKKEN

There exist various kinds of boring applications which cannot be managed using standard boring arbors. NIKKEN has great experience of special boring applications, utilizing the double contact shoulder support ZMAC boring heads. NIKKEN can also design and manufacture special boring arbors to suit your special applications.

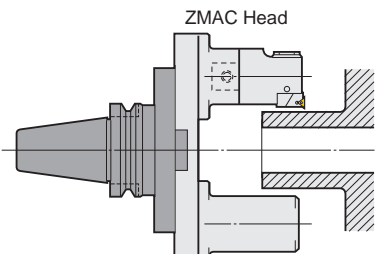


RAA

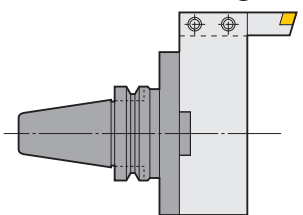
Base Arbor for Special Boring Head



For Overturning



For U Axis Boring Arbor

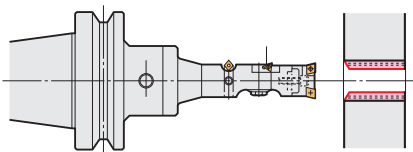


TAPER	Code No.	D ₁	L	H ₁	H ₂	C ₁	C ₂	C ₃	Weight (kg)
No.40	BT40-RAA32- 60 (IT40)	32 h7	60	7	15	102	61	82	2.5
	No.50		BT50-RAA32- 60 (IT50)		60				
120					20				
180				15.5					

★The Base Holder with long gauge length is available on demand.
 ★High Pressure Centre Through Tool Coolant Type is available on demand.
 ★The dimension with () is for IT40 and IT50.
 ★For BT40, φD₁=22mm is also available.

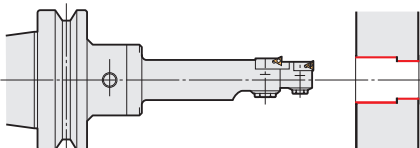
Multi Stage Boring Arbor

For Simultaneous machining for rough, finish and chamfer.



Please specify the boring dia., depth, and necessary length from the gauge line.

For stepped hole boring with restricted concentricity.



Please specify each boring dia., depth, and necessary length from the gauge line.

For decreasing the number of A.T.C with one arbor for two different size of the bores.

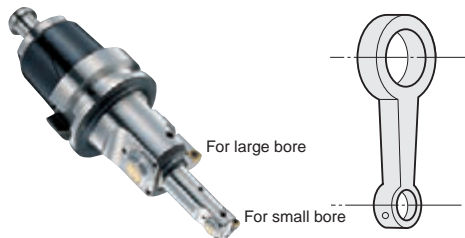


Photo shows with NC5 Shank.

The above are just samples. Pre-Balanced type Boring Arbor for High Speed Application and Aluminium Body Head are also available. Please contact with us about your special boring applications.

DRILLING OPERATION by COMBAT Z DRILL



“Rationalization is Study of Drilling.” which is our Slogan for developing NIKKEN COMBAT Z DRILL. P.255 Please try it. Pilot Drill and 3-Phases Heat Treatment significantly improves Cutting Condition, Secure Drilling and Tool Life.

Ultra Long Size Boring Bar

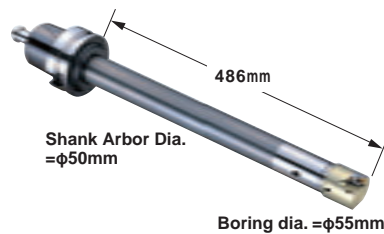
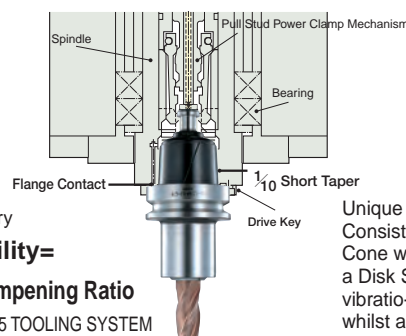


Photo shows with NC5 Shank.

For Extreme Deep Hole Boring Operation, please study the Machine with NC5 Spindle P.193 or 3LOCK Spindle P.139. In case of BT/IT spindle, we recommend ZMAC type Head for these applications.



E · H · MERRITT's Theory

Chattering Stability=

Static Stiffness × Dampening Ratio

Thus, the advantage of NC5 TOOLING SYSTEM is clearly demonstrated.

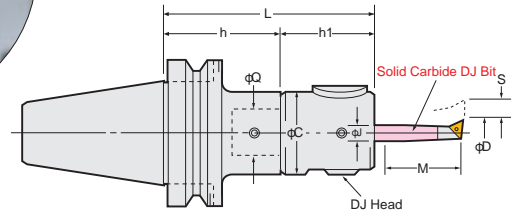
Unique Construction : Consist-ing of a Slotted Taper Cone which is Pre-Loaded by a Disk Spring to increase its vibratio-nal dampening effect whilst ad-justing minute gaugeline errors, completely.

BT

DJ BORING BAR



High Pressure Coolant Through Tool is available. Please contact us.



BT-DJ

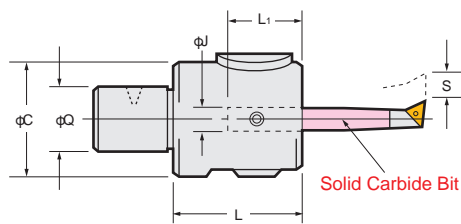
TAPER	Code No.	Boring Range	Boring Depth	L	C	Bit Hole Size	Shank Code No.	Head Code No.	Bit Stroke	DJ Bit Code No.	Weight (Kg)
		D	M			J	BTNo.Q-h	Q-MinD-h ₁	S		
No.30	BT30-DJ3- 76	3~28	14~ 80	76	45	10	BT30-Q26- 40	Q26-DJ3-36	5.2	J10	1.0
	-DJ8- 84AN	3~50	14~130	84	59	16		-DJ8-44AN	6.0	J16	1.2
No.40	BT40-DJ3- 86	3~28	14~ 80	86	45	10	BT40-Q26- 50	Q26-DJ3-36	5.2	J10	1.6
	(IT40) -131			131							
	-DJ8- 94AN	3~50	14~130	94	59	16	BT40-Q26- 50	-DJ8-44AN	6.0	J16	1.9
	-139AN			139							- 95
No.50	BT50-DJ3-101	3~28	14~ 80	101	45	10	BT50-Q26- 65	Q26-DJ3-36	5.2	J10	4.2
	(IT50) -206			206							
	-DJ8-109AN	3~50	14~130	109	59	16	BT50-Q26- 65	-DJ8-44AN	6.0	J16	4.5
	-214AN			214							-170N

- ★MIN. dial readout on dia.: 0.01mm, Sub scale: 0.005mm, 0.8mm/rev.
- ★Each boxed set of DJ3 and DJ8 Boring Bars include 4 pcs of DJ Boring Bits as standard.
- ★Bits included for BT40-DJ8-94A : J16-8-40, J16-18-80, J16-28-85, J16-38-85
- ★Bits included for BT40-DJ8-94AN : J16-8-40, J16-18-60, J16-28-65, J16-38-65
- ★DJ Boring Bar without Boring Bits is also available. Please add “-BD” at the end of Code No. e.g. BT40-DJ3-86-BD
- ★Shank and DJ Head (including Boring Bits) are delivered in separate packages.
- ★Please refer P.84 for Boring Bits. Please refer P.97 for cutting condition.

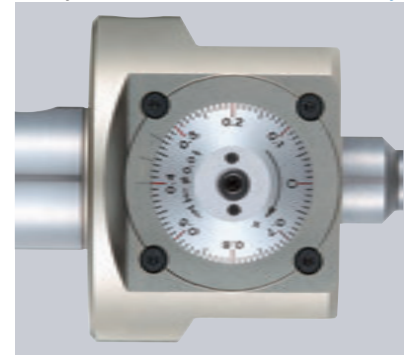
DJ BORING HEAD with DJ BORING BIT



DJ



Easy to Set Micron Accuracy



▲ 1 Graduation: 0.01mm on dia.

DJ No.	Code No.	Boring Range	Boring Depth	Q	L	C	Bit Hole Size	L ₁	Bit Stroke	Weight (kg)	Bit Code No. (Standard Accessories)	Insert Tip Code No.
		D	M				J		S			
DJ3	Q26-DJ3-36	3~28	14~80	26	36	45	10	24	5.2	0.5	J10- 3-14	—
											J10- 5-35	CC03-C
											J10- 8-40	3MP-C
											J10-18-65	6MP-C
DJ8	Q26-DJ8-44AN	3~50	14~130	26	44	59	16	32	6.0	0.8	J16- 8-40	3MP-C
											J16-18-60	6MP-C
											J16-28-65	
											J16-38-65	

- ★MIN. dial readout on dia.: 0.01mm, Sub scale: 0.005mm, 0.8mm/rev.
- ★Each boxed set of DJ3 and DJ8 Boring Bars include 4 pcs. of DJ Bits, Insert, Insert Clamp Handle, (T6, T8, (10S for DJ3) Micro Adjusting Handle (M2.5) as standard.
- ★Bits included for Q26-DJ8-44A : J16-8-40, J16-18-80, J16-28-85, J16-38-85
- ★Bits included for Q26-DJ8-44AN : J16-8-40, J16-18-60, J16-28-65, J16-38-65
- ★Please refer P.84 for Boring Bits. Please refer P.97 for cutting condition.
- ★DJ Boring Head without Bits is also available. Please add “-BD” at the end of Code No. e.g. Q26-DJ3-36-BD, Q26-DJ8-44A-BD
- ★Weight of wooden box of DJ Head with Boring Bits: Q26-DJ3-36 : 1.2kg, Q26-DJ8-44AN : 2.2kg, Q26-DJ8-44A : 2.5kg

DJ BORING BIT SOLID CARBIDE

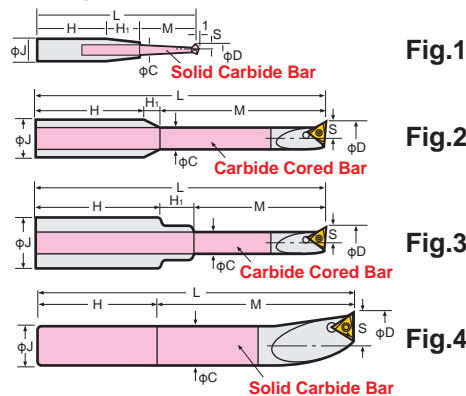
NIKKEN

NEW

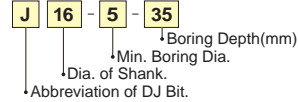


φ3~8mm

New Bit Series for DJ8



Explanation of the Code No.

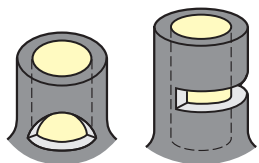


Style	Code No.	Boring Range	Boring Depth	J	L	H	H ₁	C	S	Insert No.	Insert Clamping Bolt No.	Insert Clamping Handle No.	Fig.	Weight (g)
		D	M											
DJ3	J10- 3- 14	3~ 8	14	10	62	30	18	2.2	1.5	-	-	-	1	30
	- 5- 35	5~15	35		70		5.0	4.3	2.5	CC03-C	M611	10S	5	30
	- 8- 40	8~18	40		75	32.5	2.5	7.2	4.0	3MP-C	M2040	T6	2	50
	- 8- 55*		55		90								11.2	6.0
	-12- 55*	12~22	65		85	26	-	12	9.0	6MP-C	M2577	T8	4	130
	-18- 65	18~28	80		91								106	130
	-18- 80*													
DJ8	J10- 3- 14*	3~ 8	14	10	62	30	18	2.2	1.5	-	-	-	7	30
	J16- 5- 25*	5~15	25	16	60	31.5	3.5	4.3	2.5	CC03-C	M611	10S	5	76
	- 5- 35*		35		78	33	10						80	
	- 8- 35*	8~18	35	70	32.5	2.5	7.2	4.0	3MP-C	M2040	T6	2	90	
	- 8- 40		40	83	32	10						100		
	- 8- 55*		55	98								110		
	-12- 50*	12~22	50	90	35	-	11.2	6.0	6MP-C	M2045	T8	2	140	
	-12- 60*		60	103	40.5	2.5						170		
	-18- 60	18~28	65	93	-	-	-	-	-	-	-	-	6	150
	-18- 80		80	113									9.0	300
	-18-100*		100	133									4	350
	-18-120*		120	153									4	400
	-28- 65		65	98									6	150
	-28- 85	28~39	85	118	33	-	16	14.0	6MP-C	M2577	T8	4	300	
	-28-100*		100	133								4	350	
	-28-130*		130	163								4	450	
	-38- 65		65	98								6	200	
	-38- 85	38~50	85	118	-	-	-	-	-	-	-	-	4	350
	-38-100*		100	133									4	370
	-38-130*		130	163									4	470

- *The Bits marked * are optional accessories.
- ★Please refer P.84 for boring bits. Please refer P.97 for cutting condition. The insert tip for J10-8,-12 and J16-8,-12 were changed from 3MS to 3MP.
- ★9DJ8-J10-ADP adapter option is necessary to use J10-3-14 for DJ8 head.
- ★The shorter bits are added for J16-5, J16-8 and J16-12. ★"C" grade (Coated) insert tip is supplied. Please refer P.97 for cutting condition.
- ★Coolant through tool is basically available for the boring bits with MIN. boring diameter is φ12mm. e.g. J16-12-60C Please contact us.

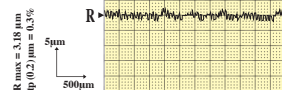
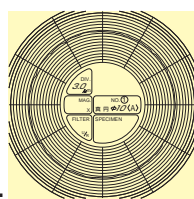
Example of hardened steel boring with CBN Insert

Reduce L/D as small as possible:MAX. 3times
For bits of L/D shorter than standard one are also available. Please contact with us.



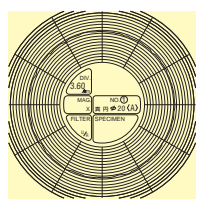
Example of intermittent boring of hardened steel (HRC60) φ10mm

Results of concentricity on 24 pcs. were all within 3μm.



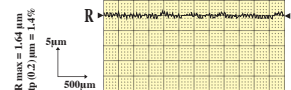
Results of surface finish on 24 pcs. were all within 3.3 microns. (R MAX.)

Results of concentricity on 24 pcs. were all within 3.6μm.



Example of intermittent boring of hardened steel (HRC60) φ20mm

No.20 C(φ20)



Results of surface finish on 24 pcs. were all within 2.8 microns. (R MAX.)

B1

BASE HOLDER for MODULAR TYPE (BT Shank)



Q

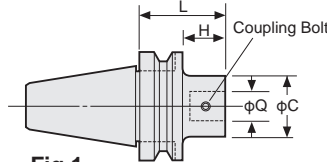


Fig.1

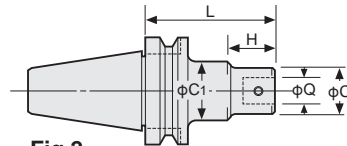


Fig.2

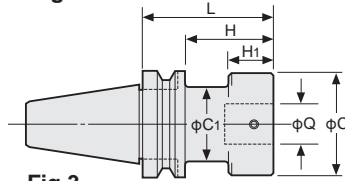


Fig.3

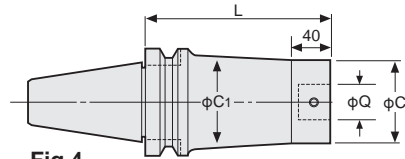


Fig.4

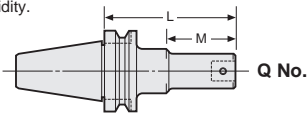
TAPER	Code No.	Coupling Dia Q	L	C	C1	H	H1	Coupling Bolt No.	Fig.	Weight (kg)
No.30	BT30-Q 9- 50	9	50	19	30	20	-	B19	2	0.5
	-Q12- 65	12	65	24	-	40		B12	1	0.5
	-Q16- 50	16	50	31		25		B16		0.5
	-Q20- 50	20	50	40		26		B20		0.5
	-Q26- 40	26	40	50		45		18		6
No.40	BT40-Q 9- 80	9	80	19	30	5	-	B19	2	1.2
	- 95N		95			27				1.2
	-Q12- 80	12	80	24	35	12		B12		1.2
	- 110		110			50				1.3
	-Q16- 95	16	95	31	42	22		B16		1.5
	- 125		125			55				1.6
	-Q20- 80	20	80	40	50	27		B20	1.5	
	- 110		110			60			1.7	
	-Q26- 50	26	50	50	-	20		B26N	1	1.1
	- 95		95			65				1.8
	- 140		140			110				2.4
	-Q34- 95	34	95	64	62	68		B34	3	2.2
	- 110		110			83				70
	-Q42- 95	42	95	83	-	68		B42	3	2.8
	No.50	BT50-Q 9- 110	9	110	19	40		5	-	B19
- 125N		125		27			4.1			
-Q12- 95		12	95	24	44	12	B12	4.0		
- 125			125			50		4.0		
-Q16- 125N		16	125	31	50	22	B16	4.5		
- 155			155			55		4.6		
-Q20- 110		20	110	40	60	27	B20	4.6		
- 125			125			60		4.5		
-Q26- 65		26	65	50	65	27	B26N	1		3.7
- 140			140			47				5.3
- 170N			170			112				5.4
-Q34- 140		34	140	64	80	102	B34	1		5.6
- 170			170			120				6.5
- 200			200			150				7.1
-Q42- 125		42	125	83	-	87	B42	1		6.5
- 190			190			152				9.1
-Q42- 225A		42	225	83	98	-	B42	4		12.9
- 275A			275							15.6
- 325A	325		18.3							
- 375A	375		21.0							

★φC of Q26 base holder has been increased from 45mm to 50mm due to improvement of its rigidity.

★All base holders have a centre through-tool coolant hole.

★The Coupling screw & wrench are supplied as standard.

★When L length is required longer than standard, please specify the boring depth M.

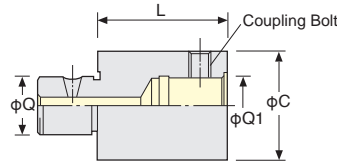


Q No.

SPACER for MODULAR TYPE

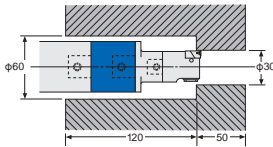


Extension Spacer



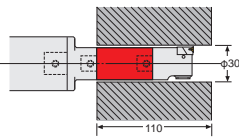
SP

Example of small diameter boring in a deep recess using the largest diameter extension spacer in order to maintain rigidity.



BT40-Q26-95
SP26-26-60
 SP26-12-30
 12-ZMAC25-40

Example of deep hole boring using the extension spacer with the same diameter as head.

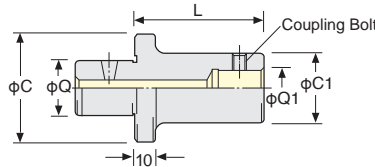


BT40-Q26-95
 SP26-12-30
SP12-12-60
 12-ZMAC25-40

Code No. Q-Q1-L	Coupling Dia		C	Coupling Bolt No.	Weight (kg)
	Q	Q1			
SP 9- 9-30, 45	9	9	19	B19	0.06, 0.1
SP 12-12-30, 45, 60	12	12	24	B12	0.1, 0.15, 0.2
SP 16-16-30, 45, 60	16	16	31	B16	0.15, 0.25, 0.35
SP 20-20-45, 60	20	20	40	B20	0.4, 0.5
SP 26-26-60, 90	26	26	50	B26N	0.8, 1.2
SP 34-34-60, 90	34	34	64	B34	1.4, 2.0
SP 42-42-60, 90	42	42	83	B42	2.4, 3.4

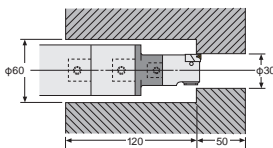
★φC of SP26 Spacer has been increased from 45mm to 50mm due to improvement of its rigidity.
 ★All spacers have a centre through-tool coolant hole. ★The Coupling screw is included as standard.

Stepped Spacer



SP

Example of small diameter boring in deep recess using stepped spacer with the same diameter as head.



BT40-Q26-95
 SP26-26-60
SP26-12-30
 12-ZMAC25-40

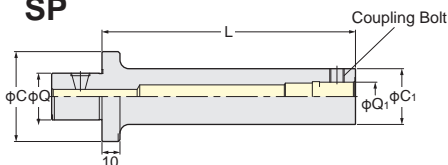
Code No. Q-Q1-L	Coupling Dia		C	C1	Coupling Bolt No.	Weight (kg)
	Q	Q1				
SP 12- 9-45	12	9	24	19	B19	0.1
SP 16- 9-45	16	9	31	19	B19	0.15
-12-60		12		24	B12	0.25
SP 20- 9-45	20	9	40	19	B19	0.2
-12-60		12		24	B12	0.3
-16-60, 90		16		31	B16	0.4, 0.6
SP 26- 9-30, 45	26	9	50	19	B19	0.3, 0.3
-12-30, 60		12		24	B12	0.3, 0.4
-16-30, 60, 90		16		31	B16	0.3, 0.5, 0.6
-20-30, 60, 100		20		40	B20	0.4, 0.6, 1.0
SP 34-16-60, 90	34	16	64	31	B16	0.7, 0.9
-20-60, 100		20		40	B20	1.0, 1.3
-26-60, 100		26		50	B26N	1.1, 1.5
SP 42-20-60, 100	42	20	83	40	B20	1.2, 1.6
-26-60, 100		26		50	B26N	1.4, 1.9
-34-60, 100		34		64	B34	1.8, 2.5

★φC of SP26 Spacer has been increased from 45mm to 50mm due to improvement of its rigidity.
 ★All spacers have a centre through-tool coolant hole. ★Coupling bolt is supplied as standard.

A1 Spacer for Deep Hole



SP



L/D:MAX.6 times

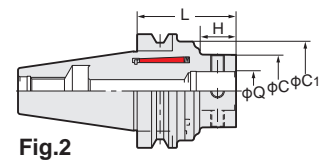
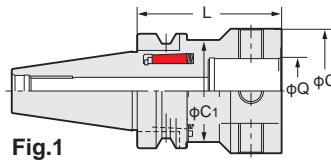
Code No. Q-Q1-L	Coupling Dia		C	C1	MAX. L	Weight (kg)
	Q	Q1				
SP 26- 9- 85-A1	26	9	50	19	85	0.6
-12-115-A1		12		24	115	0.7
-16-140-A1		16		31	140	0.9
-20-180-A1		20		40	180	1.2
-26-190-A1		26		50	190	1.5

Please specify the "L" length when ordering. Code No. is e.g SP26-9-85-A1 (Q1=9 and L=85)



Modular connection system is the face contact system drawing-in by the bolt, which top shape is gentle taper.

1. Insert a head by adjusting the hole positions.
2. Tighten the bolt temporary, then loosen slightly.
3. Tighten the bolt again by moving the head CW and CCW. (Centering each other)
4. Then tighten the bolt completely until face contact.

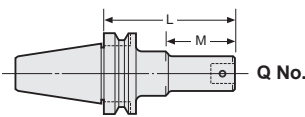


MDQ

Photo shows with A1 spacer and ZMAC head.

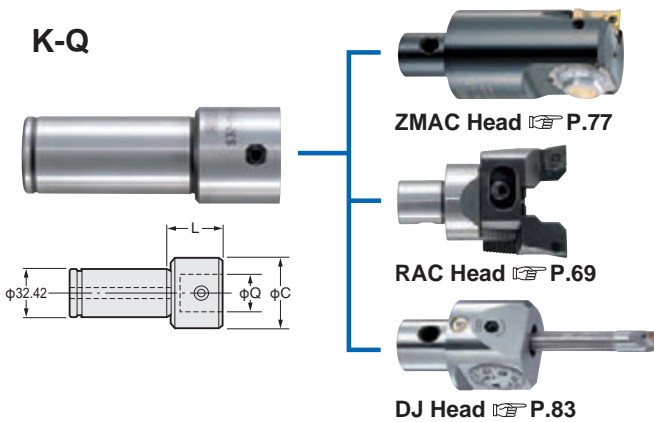
TAPER	Code No.	Q	L	C	C1	H	Weight (kg)	ZMAC Boring Range	Fig
No.30	NBT30-MDQ26- 60	26	60	50	50	37.5	-	16~70	1
No.40	NBT40-MDQ26- 65	26	65	50	54	30.0	1.3	16~70	2
No.50	NBT50-MDQ26- 80	26	80	50	87	22.0	4.6	16~70	2
	-MDQ34- 90	34	90	64	87	32.0	4.9	16~85	
	-MDQ42-100	42	100	83	87	45.0	5.7	16~180	

- ★All base holders are used for centre through tool coolant.
- ★Coupling bolt and wrench are supplied as standard.
- ★ZMAC head is recommended to use with the MAJOR DREAM base holder for anti-vibration.
- ★When L length is required longer than standard, please specify the boring depth M and Q No.



MODULAR TYPE STRAIGHT SHANK

K-Q



Code No.	Coupling Dia.	C	L	Coupling Bolt.	Weight (Kg)
	Q				
K32-Q 9-20	9	19	20	B19	0.4
-40			40		0.5
-Q12-20	12	24	20	B12	0.4
-60			60		0.6
-Q16-20	16	31	20	B16	0.5
-55			55		0.7
-Q20-40	20	40	40	B20	0.7
-Q26-40	26	50		B26N	0.8
K42-Q26-40				B26N	1.2

★All straight shank base holders are used for centre through tool coolant.

CHANFERING CUTTER for Modular System

CAF



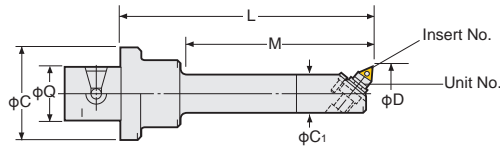
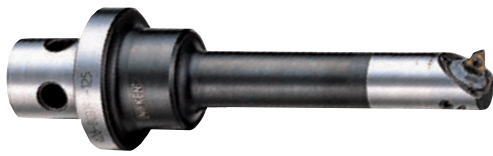
Code No.	Coupling Dia.	Chamfering Dia.	Code No.	Coupling Dia.	Chamfering Dia.
CAF 9- 32	9	20~32	CAF20- 60	20	42~60
CAF12- 38	12	25~38	CAF26- 85A	26	56~85
CAF16- 45	16	33~45	CAF34-110	34	70~110

★Chamfering angle is 45°

MODULAR TYPE BORING HEAD

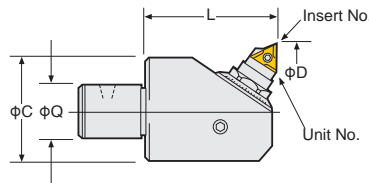
NIKKEN

BCB Micro-Cut Boring Head



Code No.	Boring Range D	Boring Depth M	Coupling Dia Q	Total Length L	C	C ₁	Unit No.	Insert No.
Q26-BCB12.7S- 95	12.7~14.5	60	26	95	50	12	M1-12.7	1MP-T
Q26-BCB14.5S-100	14.5~19.5	65		100		13	M1-14.5	
Q26-BCB19 S-125	19 ~22.5	90		125		18	M2-19	

★“T” grade (Cermet) insert is supplied as standard. P.98 Please refer P.96 for cutting condition.

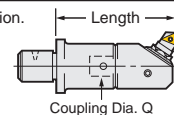


Set/Head Code No	Boring Range D	Boring Depth M	Coupling Dia Q	Remarks		
				C	Unit No.	Insert No.
9-BCB 22 - 40	22 ~29.5	40	9	20	M 2- 22	3MS-T
12-BCB 29 - 40	29 ~ 41		12	25	M 3- 29	
16-BCB 38 - 55	38 ~ 50	55	16	35	M 5- 38	6MP-C
20-BCB 48 - 70	48 ~ 65	70	20	41	M 5- 48	
26-BCB 62 - 70	62 ~ 90		26	54	M 7- 62	10MP-T
34-BCB 82 - 85	82 ~ 110	34	67			
42-BCB100 -100	100~140	100	42	85	M10-100	

★“6MP-C” (Coaterd) insert or “T” grade (Cermet) insert is supplied as standard. P.98 Please refer P.96 for cutting condition.

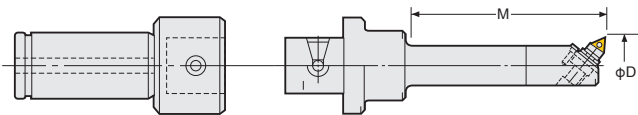
★Min. dial readout (on dia) : 0.02mm (Sub scale : 0.002mm)

★Code No. of the set with SP26 stepped spacer is Q26-Coupling Dia.-BCB○-Length e.g. Q26-20-BCB48-100



Straight Shank MICRO CUT BORING BAR

NIKKEN



The sales of micro cut boring bar will be finished, when the stock is sold out.



K-BCB

Style	Code. No.	Q Holder Code. No.	Head No.	Boring Range φD	Boring Depth	Insert No.
K32	K32-BCB12.7S-135	K32-Q26-40	Q26-BCB12.7S- 95	12.7~14.5	60	1MP-T
	-BCB14.5S-140		-BCB14.5S-100	14.5~19.5	65	

★Please refer P.87 for straight shank base holder and P.88 for micro cut head.

★“T” grade (Cermet) Insert is supplied as standard. P.98 Please refer P.96 for cutting condition.

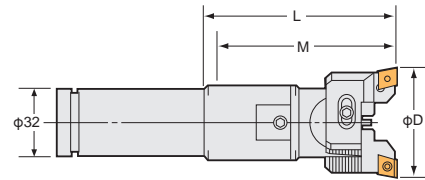
★Please use ZMAC Boring Bar for the bore dia. is larger equal to φ16mm. P.88

Straight Shank BALANCE CUT BORING BAR

NIKKEN



$\phi 32$



K-RAC

You can use following boring tools with C32 Milling Chuck. It is convenient for Various/Small Volume Productions. Use with Straight Shank ZMAC Boring Bar.

P.62

Code No.	Boring Range D	Boring Depth M	Shank Code No.	Head No.	Insert No.	Weight (kg)
K32-RAC25- 75E	25~ 32	70	K32-Q12-20	12-RAC025- 55E	CC07-C	0.8
-115E		93	-Q12-60			0.9
-RAC32- 75E	32~ 45	70	-Q16-20	16-RAC 32- 55E	CC08-C	1.1
-110E			-Q16-55			1.3
-RAC43-110E	43~ 55	105	-Q20-40	20-RAC 43- 70E	CC12-C	1.7
-RAC53-110E	53~ 70		-Q26-40	26-RAC 53- 70E		1.8
-RAC70-110E *	70~ 100			26-RAC 70- 70E		1.9

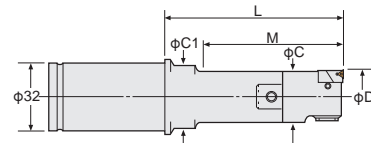
★Balance cut boring bar on above table is the boring bar with the cartridges (E) for steel, stainless and cast iron. "C" grade (Coated) insert tip is supplied as standard. **P.62**
 ★Boring bar with the cartridges for heavy duty boring of iron and cast iron **P.64**, for aluminium (A) **P.66** and for through hole and multi sheets (K) . **P.68**
 Please refer **P.95** for cutting condition.
 ★Shank (P.87) and head (P.69) are delivered in separate packages.
 ★For centre through tool coolant type except **K32-RAC70-110E** marked *, please add "C" at the end of Code No. e.g. **K32-RAC53-110E-C**

Straight Shank Z MAC BORING BAR

NIKKEN



$\phi 32$



K-ZMAC

You can use following boring tools with C32 Milling Chuck. It is convenient for Various/Small Volume Productions.

Code No.	Boring Range D	Boring Depth M	C	C ₁	Shank Code No.	P.98		P.74		Weight (kg)
						Head No.	Insert No.	Head No.	Insert No.	
K32-ZMAC16- 65	15.9~20.2	38	15	-	K32-Q12-20	12-ZMAC16-45				0.5
- 75		48				12-ZMAC16-55				0.5
-ZMAC20- 60	19.8~25.2	55	19	-	-Q 9-20	9-ZMAC20-40	3MP-C,B			0.6
- 80		63								-Q 9-40
-ZMAC25- 60	24.8~32.2	55	24	-	-Q12-20	12-ZMAC25-40				0.6
-100		83								-Q12-60
-ZMAC32- 75	31.8~42.2	70	31	-	-Q16-20	16-ZMAC32-55	4MP-C,B	16-ZMAC32R-55	CC06-C	0.9
-110										-Q16-55
-ZMAC42-110	41.8~55.2	105	40	-	-Q20-40	20-ZMAC42-70	6MP-C,B	20-ZMAC42R-70		1.5
-ZMAC55-110	54.8~70.2		53		-Q26-40	26-ZMAC55-70		26-ZMAC55R-70		1.6

★All Codes shown are for Heads with Triangular Inserts.

For Heads with Rhomboid Inserts, please add "R" to the Code No. e.g.) **K32-ZMAC32 R -75**

★MIN. dial read out: **ZMAC25** and smaller is 0.02mm on dia. **ZMAC32** and larger is 0.01mm on dia.

★"C" grade (coated) Insert for Steel, Stainless and Cast Iron is supplied as standard with the Head. (Smooth Boring and Long tool-life) Please refer **P.96** for cutting condition.

We would recommend "B" grade (CBN) Insert for Hardened Steel and High Speed Boring of Cast Iron.

★For Centre Through Tool Coolant type, please add "C" at the end of Code No. e.g. **K32-ZMAC42-110C**.

Straight Shank DEEP HOLE ZMACX BORING BAR



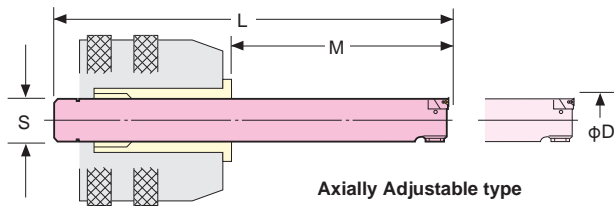
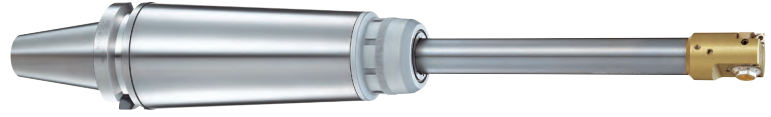
Axially Adjustable and **Solid Carbide**



For Deep Hole Boring



For Deep Hole Boring with Extended Gauge Length



ZMACX25, 32, 42 are the centre through tool coolant type with ZMACX head as standard.



S-ZMACX

Code. No.	Boring Range D	Boring Depth M	L	S	Unit No.	Insert No.	Weight (kg)	Suitable Holder	
								Chuck	KM Collet
S12-BCBX12.7- 95	12.7~14.5	50~95	130	12	M1-12.7	1MP-T	0.2	BT40-C32 BT50-C32	KM32-12
S13-BCBX14.5-105	14.5~19.5	50~105	135	13	M1-14.5				-13
S15-ZMACX16-120	15.9~20.2	65~120	150	15	M2HZ-16	3MP-C, B	0.3		-15
S19-ZMACX20-150	19.8~25.2	100~150	180	19	M2HZ-20		0.6		-19
S24-ZMACX25-190C	24.8~32.2	140~190	220	24	M3HZ-25	1.3	-24		
S30-ZMACX32-260C	31.8~42.2	190~260	290	30	M4HZ-32	4MP-C, B	2.6		-30
S32-ZMACX42-330C	41.8~55.2	260~330	360	32	M5HZ-42	6MP-C, B	3.8	-	

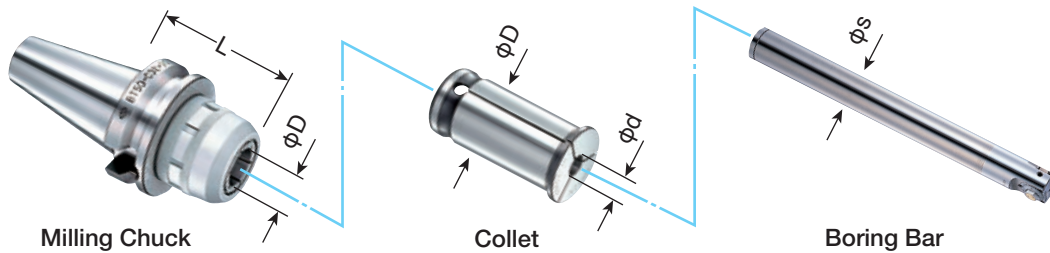
★T grade (Cermet) insert tip or "C" grade (Coated) insert tip is supplied as standard for BCBX or ZMACX respectively. P.98 Please refer P.96 for cutting condition.

★Centre Through Tool Coolant type is available. Please add "C" at the end of Code No. e.g. S19-ZMACX20-150C

Deep Hole Boring Operation with combination of Milling Chuck, Collet and S-ZMACX Boring Bar.

Ultra Deep Hole Boring MAX.L/D=8 times with Carbide Solid Boring Bar

Axially Adjustable with Milling Chuck



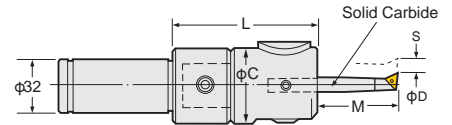
TAPER	Milling Chuck Code No.	Collet
No.40	BT40 -C20- 70, 90, 105, 120	KM20
	-C25- 70, 90, 120	KM25
	-C32- 85, 105, 120	KM32
No.50	BT50 -C20-105, 135, 165, 180	KM20
	-C25-105, 135, 165	KM25
	-C32- 90, 105, 120, 135, 165	KM32
	-C42- 95, 105, 120, 135, 165	KM42

KM Collet No.
KM20-12
-13
KM25-12
-13
-15
KM32-12
-13
-15
-19
-24
-30
-

Deep Hole Boring Bar Code No.
S12-BCBX12.7- 95
S13-BCBX14.5-105
S12-BCBX12.7- 95
S13-BCBX14.5-105
S15-ZMACX16-120
S12-BCBX12.7- 95
S13-BCBX14.5-105
S15-ZMACX16-120
S19-ZMACX20-150
S24-ZMACX25-190
S30-ZMACX32-290C
S32-ZMACX42-360C

★KM42-12, 13, 15, 19, 24 are also available.

Straight Shank DJ BORING BAR



K-DJ

You can use following boring tools with C32 Milling Chuck. It is convenient for Various/Small Volume Productions.



Code No.	Boring Range D	Boring Depth M	L	C	Bit Hole Size L	Shank Code No.	Head No.	Bit Stroke S	Bit Code No.	Weight (kg)
K32-DJ3-76	3~28	14~ 80	76	45	10	K32-Q26-40	Q26-DJ3-36	5.2	J10	1.3
-DJ8-84AN	3~50	14~130	84	59	16		-DJ8-44AN	6.0	J16	1.6

- ★MIN. dial readout on dia.: 0.01mm, Sub scale: 0.005mm, 0.8mm/rev.
- ★Each box set of DJ3 and DJ8 Boring Bar includes 4 pcs of Boring Bits and insert tips.
- ★Bits included to **K32-DJ8-84A** : J16-8-40, J16-18-80, J16-28-85, J16-38-85
- ★Bits included to **K32-DJ8-84AN** ; J16-8-40, J16-18-60, J16-28-65, J16-38-65
- ★Please refer P.84 for Boring Bit. Please refer P.97 for cutting condition.
- ★DJ Boring Bar without Boring Bits is available. Please add “-BD” at the end of Code No. e.g. K32-DJ8-84A-BD

MULTI STAGE BORING BAR



Please provide your material drawing, machining drawing and machine information for multi stage boring bars.

Multi-Boring



Rough Boring by ISO Cartridge



Boring, Over Turning



Rough Boring by ISO Cartridge

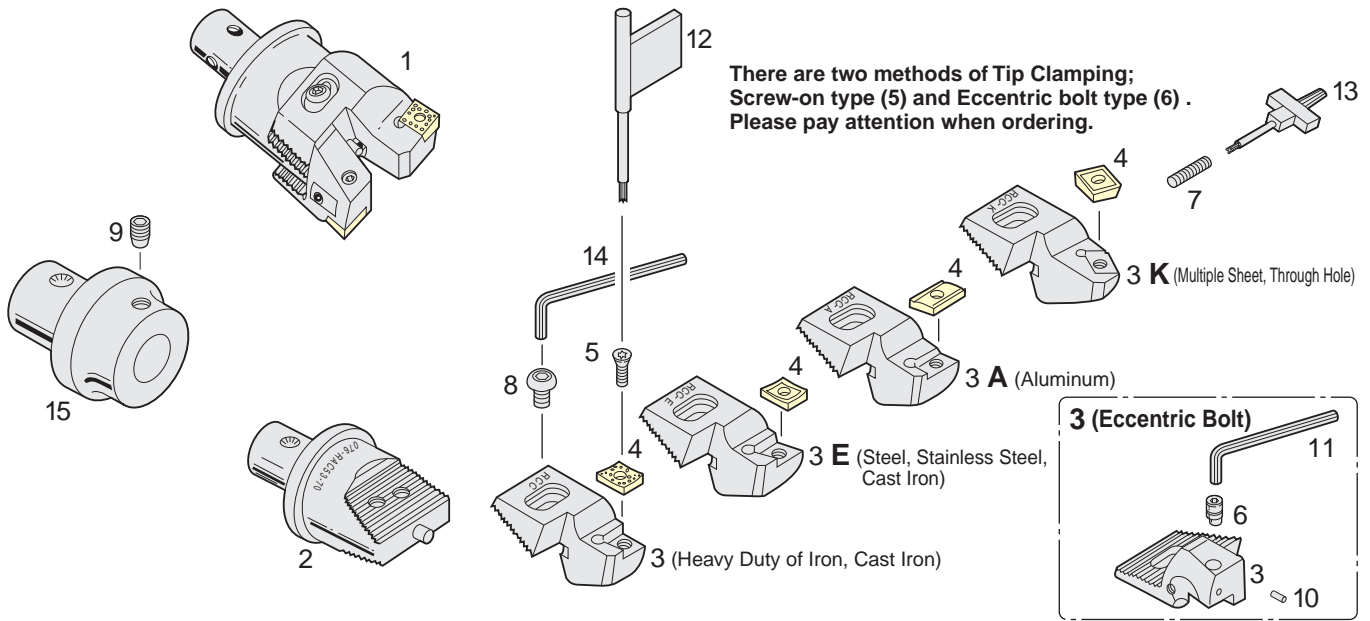


Multi-Boring



Please supply ISO cartridges basically, even we can provide by ourselves.

BALANCE CUT BORING UNIT PARTS LIST



Boring Range	1	2	3	4	5	6	7	8	9	10	11	12	13	14	15		
	RAC Head	RAC Base	Cartridge	Tip	Tip Clamping Bolt	Eccentric Bolt	Adjusting Screw	Cartridge Clamping Bolt	Set Screw	Copper Pin	Tip Clamping L-Wrench	Tip Clamping Handle	Wrench for Adjustment	L-Wrench for Cartridge	Stepped Spacer		
φ 25~ 32	12-RAC025- 55E	12-RAC025- 55B	RCC-025E	CC07	M3070	—	M508	G-25	B12	—	—	T10	—	—	M3	SP26-12-30	
	- 55A		- 25A	AEG12													
	- 55K		- 25K	SC09													
φ 32~ 45	16-RAC 32- 55E	16-RAC 32- 55B	RCC- 32E	CC08	M4090	—	M512	G-32	B16	—	—	T15	—	—	M4	SP26-16-30	
	- 55A		- 32A	AEG12													
	- 55K		- 32K	SC09	M3070							T10					
φ 43~ 55	20-RAC 43- 70	20-RAC 43- 70B	RCC- 43	CN08	CSM-70	CSM-43	M514	G-43	B20	R12	M3	20S	—	—	M5	SP26-20-30	
	- 70E		- 43E	CC12	M5012	—				—	—	—					
	- 70A		- 43A	AEG16	M4090												T15
	- 70K		- 43K	SC12	M5012												
φ 53~ 70	26-RAC 53- 70	26-RAC 53- 70B	RCC- 53	CN08	CSM-70	CSM-43	M518	G-53	—	R12	M3	20S	M2.5	—	—	—	
	- 70E		- 53E	CC12	M5012	—				—	—	—					
	- 70A		- 53A	AEG16	M4090												T15
	- 70K		- 53K	SC12	M5012												
φ 70~100	26-RAC 70- 70	26-RAC 70- 70B	RCC- 70	CN08	CSM-70	CSM-43	M528	G-70	—	R12	M3	20S	—	—	M6	—	
	- 70E		- 70E	CC12	M5012	—				—	—	—					
	- 70A		- 70A	AEG16	M4090												T15
	- 70K		- 70K	SC12	M5012												
	34-RAC 70- 85	34-RAC 70- 85B	RCC- 70	CN08	CSM-70	CSM-43	M528	G-70	—	R12	M3	20S	—	—	—	—	
	- 85E		- 70E	CC12	M5012	—				—	—	—					
	- 85A		- 70A	AEG16	M4090												T15
	- 85K		- 70K	SC12	M5012												
φ 100~130	42-RAC100-100	42-RAC100-100B	RCC-100	CN08	CSM-70	CSM-43	M538	G-70	—	R12	M3	20S	—	—	—	—	
	-100E		-100E	CC12	M5012	—				—	—	—					
	-100A		-100A	AEG16	M4090												T15
	-100K		-100K	SC12	M5012												

★You can use only one type RAC Base irrespective of material and work piece. Suitable Cartridge and Carbide Insert must be selected. P.69

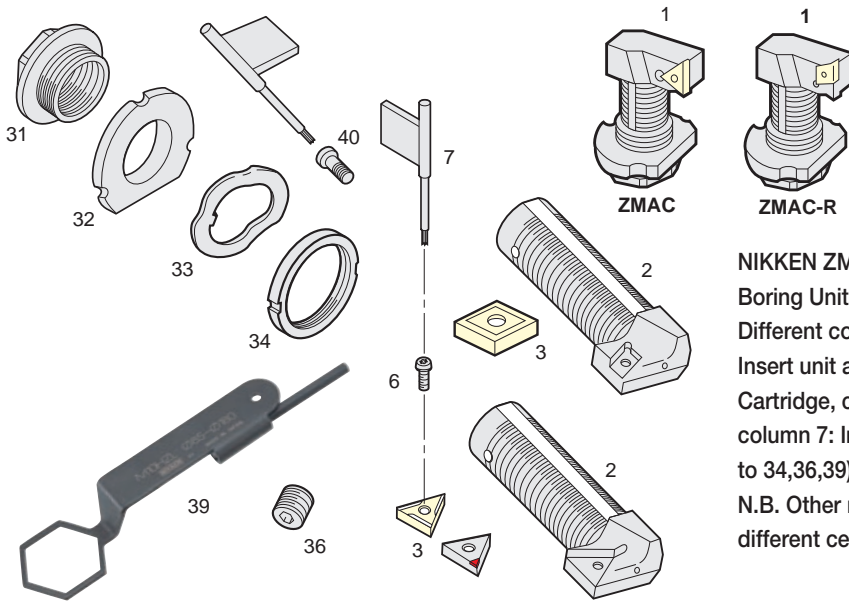
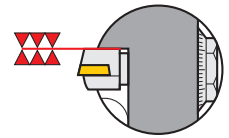
★Insert tip is available as an option.

★There are 2 methods of Tip Clamping; Screw-on type (5) and Eccentric Bolt type (6). Please pay attention when ordering for spare parts.

★Code No. of Cartridge means for Cartridge only. When ordering for cartridge set, please use set Code No. e.g. "S.RCC-025".

★The Code No. of Tip Clamping Handle is unified to T10, T15 and 20S.

ZMAC UNIT PARTS LIST



NIKKEN ZMAC Boring Heads come complete with ZMAC Boring Unit. See below part No. for spares.
 Different codes for the Triangular Insert unit & Rhomboid Insert unit are shown below : column 1: Boring unit, column 2: Cartridge, column 3: Insert, column 6: Insert clamp screw, column 7: Insert clamp handle, but all other parts (column 31 to 34,36,39) are common to both.
 N.B. Other manufacturers ISO Standard Insert Tip may have different centre hole diameters.

Boring Range	1	2	3	6	7	31	32	33	34	36	39	40	
	ZMAC Unit	Cartridge	Triangular Insert	Insert Clamp Screw	Insert Clamp Handle	Dial Ring	Lock Flange	Wave Spring	Preload Nut	Lock Screw	Adjustment Handle	Unit Clamp Bolt	
15.9~20.2	M 2HZ- 16	M 2HZ- 16C	3MP-C,B	M2045	T6	9M216D	9M216L	9M216W	9M216P	M361	M 2HZL-A	M2045	
19.8~25.2	M 2HZ- 20	M 2HZ- 20C				9M220D	9M220L		M362	M 2HZL-B			
24.8~32.2	M 3HZ- 25	M 3HZ- 25C				9M325D	9M325L	M333	9M325P	M363	M 3HZL		
31.8~42.2	M 4HZ- 32	M 4HZ- 32C	4MP-C,B	M2070	T8	9M432D	9M432L	M334	M344	M365	M 4HZL	M2577	
41.8~55.2	M 5HZ- 42	M 5HZ- 42C	6MP-C,B	M2577 (M2562D)*		9M542D	9M542L	M335	9M542P	M364	M 5HZL		
54.8~70.2	M 5HZ- 55	M 5HZ- 55C				9M770D	9M770L	M337	9M770P	M360	M 7HZL		M3090
69.8~85.2	M 7HZ- 70	M 7HZ- 70C				9M108D	9M108L	M330	9M108P	M367	M10HZL		M4012
84.8~100.2	M10HZ- 85	M10HZ- 85C								M368			
99.5~140.5	M10HZ-100	M10HZ-100C								M369			
139.5~180.5	M10HZ-140	M10HZ-140C											

★Each Unit and Cartridge are supplied without Insert Tip.
 ★Cartridge for base forming of bore is an option. Please specify the diameter and width of base forming.
 ★For Diamond Insert Tip (6MP-D), M2562D* must be used.
 ★Cartridge can not be supplied alone, please order ZMAC unit.



Special cartridge example for necking is available. Please contact us with the work piece drawing.

The cartridge head can be exchanged itself for the head bigger equal to ZMAC42.

Boring Range	1	2	3	6	7
	ZMAC Unit	Cartridge	Rhomboid Insert	Insert Clamp Screw	Insert Clamp Handle
31.8~42.2	M 4HZ- 32R	M 4HZ- 32RC	CC06-C	M2560	T8
41.8~55.2	M 5HZ- 42R	M 5HZ- 42RC		M2577	
54.8~70.2	M 5HZ- 55R	M 5HZ- 55RC			
69.8~85.2	M 7HZ- 70R	M 7HZ- 70RC	CC08-C	M4090	T15
84.8~100.2	M10HZ- 85R	M10HZ- 85RC		M4012	
99.5~140.5	M10HZ-100R	M10HZ-100RC	CC12-C	M5012	T15
139.5~180.5	M10HZ-140R	M10HZ-140RC			

Boring Range	Cartridge Head		Head Clamp Bolt
	Triangular	Rhomboid	
41.8~55.2	M 5HZ- 42CH	M 5HZ- 42RCH	M512C
54.8~70.2	M 5HZ- 42CH	M 5HZ- 42RCH	
69.8~85.2	M 7HZ- 70CH	M 7HZ- 70RCH	
84.8~100.2	M10HZ- 85CH	M10HZ- 85RCH	M825
99.5~140.5	M10HZ-100CH	M10HZ-100RCH	M835
139.5~180.5	M10HZ-100CH	M10HZ-100RCH	M835

★Each Unit and Cartridge are supplied without Insert Tip.
 ★Cartridge can not be supplied alone, please order ZMAC unit.

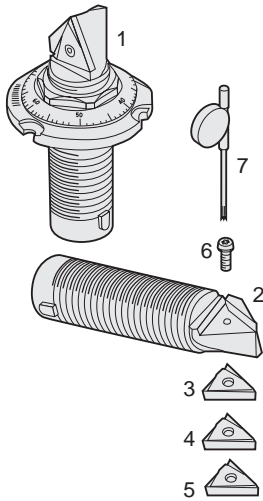
Detach •Loosen head clamp bolt after boring diameter is set to little larger than the MIN. boring diameter.
Attach •Insert the head into cartridge, then tighten head clamp bolt temporary.
 •Loosen side lock bolt.
 •Rotate the dial ring 0.2~0.3mm to minus direction.
 •Tighten head clamp bolt by pushing the head to the support portion of the main body.

MICRO-CUT BORING UNIT PARTS LIST



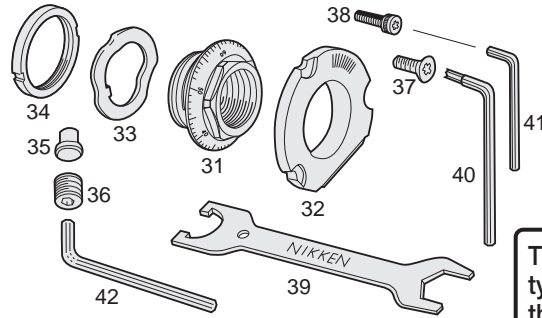
BCB

Screw on type



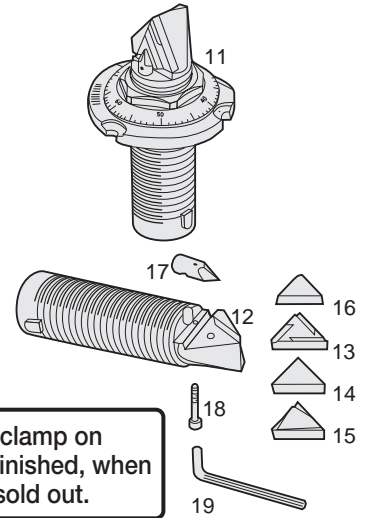
Relation between Micro-Cut Boring Arbor and Micro-Cut Boring Unit

NIKKEN Micro-Cut Boring Arbor is provided with Micro-Cut Boring Unit. When ordering each parts for spare, please place the order by Code No. of Insert, Cartridge and Unit of the following parts list.



BCB

Clamp on type



The sales of clamp on type will be finished, when the stock is sold out.

Boring Range	Screw on type							Clamp on type								
	1	2	3	4	5	6	7	11	12	13	14	15	16	17	18	19
	BCB Unit	Cartridge	Insert for Alloy Steel	Insert for Cast Iron	Insert for Steel, Stainless Steel	Insert Clamp Bolt	Insert Clamp Handle	BCB Unit	Cartridge	Insert for Alloy Steel	Insert for Cast Iron	Insert for Steel, Stainless Steel	Insert Breaker	Clamp Piece	Insert Clamp Bolt	Insert Clamp Handle
12.7~14.5	M 1-12.7	—	1MP-E	1MP-F	1MP-T	M61	10S	M 1S-2	M 1S-2C*	—	—	—	—	—	—	—
14.5~19.5	M 1-14.5	—						M 1L-2	M 1L-2C*	—	—	—	—	—	—	—
19 ~22.5	M 2-19	M 2-19 C	3MS-E	3MS-F	3MS-T	M68	13S	M 2S-2	M 2S-2C*	—	—	—	—	—	—	—
22 ~29.5	M 2-22	M 2-22 C						M 2L-2	M 2L-2C*	—	—	—	—	—	—	—
29 ~ 41	M 3-29	M 3-29 C				M 3L-2S	M 3L-2SC	3P-E	3P-F	3P-T	—	CP- 3	B183	M1.5		
38 ~ 50	M 5-38	M 5-38 C	6MP-E	6MP-F	6MP-C	M2577	T8	M 5S-2S	M 5S-2SC	5P-E	5P-F	5P-T	5CB	CP- 5	B185	M2
48 ~ 65	M 5-48	M 5-48 C						M 5L-2S	M 5L-2SC							
62 ~ 90	M 7-62	M 7-62 C	10MP-E	10MP-T	10MP-T	M67	20S	M 7L-2S	M 7L-2SC	7P-E	7P-F	7P-T	7CB	CP- 7	B187	M2.5
82 ~ 110	M 7-62	M 7-62 C						M 10L-2S	M 10L-2SC							
100 ~ 140	M10-100	M10-100 C	—	—	—	M60	—	M10L-2S	M10L-2SC	10P-E	10P-F	10P-T	10CB	CP-10	B180	M3

★Each Unit and Cartridge are supplied without Insert Tip.

★All brazed types marked * were stopped production on 2007 JAN.

★Each unit and cartridge are supplied without insert tip.

★Brazed type is available for the diameter of φ29~φ200.

Boring Range	31	32	33	34	35	36	37	38	39	40	41	42
	Dial Ring	Lock Flange	Wave Spring	Pre-Load Nut	Lock Metal	Lock Screw	Unit Mounting Bolt A	Unit Mounting Bolt B	Adjustment Handle	Wrench for Unit Mounting Bolt A	Wrench for Unit Mounting Bolt B	Wrench for Lock Screw
12.7~14.5	B311	B321	B331	B341	B351	B361	—	B381	M391	—	M1.27	M1.5
14.5~19.5												
19 ~22.5	B312	B322	9M216W	9M216P	B352	B362	—	B382	M392	—	T6	M2
22 ~29.5						M363						
29 ~ 41	B313	B323	M333	9M325P	B353	B363	—	B384	M393	—	13S	M2.5
38 ~ 50												
48 ~ 65	B315	B325	M335	9M542P	B355	B365	—	B386	M395	—	20S	M3
62 ~ 90												
82 ~ 110	B317	B327	M337	9M770P	B357	B367	—	B387	M397	M407	M405	M5
100 ~ 140						B368						
	B310	B320	M330	9M108P	B350	B360	M370	—	M390	M400	—	M6

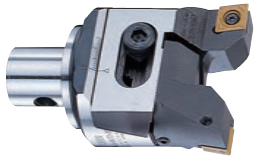
★31, 32, 33 and 34 are set for spare parts. When ordering, please add "D" at the end of Code No.
e.g. D.M2-22 for Boring Range: φ22~29.5mm

B1

BALANCE-CUT BORING ARBOR CUTTING DATA



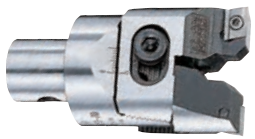
CN (Positive type) RAC-E



CC (Negative type) RAC



RAC-A



RAC-K



Material

Steel

60~150m/mim. (Dry or Wet cutting)

Stainless Steel

40~80m/mim. (Wet cutting)

Cast Iron

60~150m/mim. (Dry or Wet cutting)

**Aluminium,
Non-ferrous metal**

200~500m/mim. (Wet cutting)

**Multiple Sheets,
Through Hole**

40~120m/mim. (Dry or Wet cutting)

Recommended cutting Speed ○...Best ○...Good ---...Unsuitable

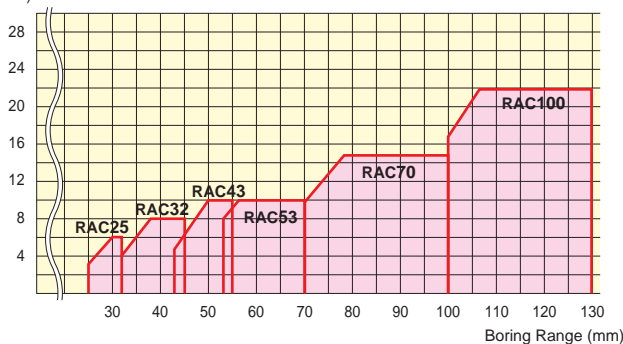
Insert		SS41	S55C	SCM	SKD	SC	FC,FCD	SUS	AL,ALC	Interrupted Cutting
Code No.	Grade									
CC	Coated Carbide M	60~120	60~150	60~150	50~80	80~120	60~150	40~80	—	○
	Coated Carbide K	—	—	—	—	80~120	60~150	—	—	—
CN	Coated Carbide M	60~120	60~150	60~150	50~80	50~80	60~150	40~80	—	○
AEG	K10	—	—	—	—	—	—	400~800	—	○
SC	Coated Carbide M	60~120	60~150	60~150	50~80	80~120	60~150	40~80	—	○
	Coated Carbide K	—	—	—	—	80~120	60~150	—	—	—

★The cutting speed is recommended to be reduced to 50% for the interrupted cutting.

★When L/D is longer, the feed rate at the entrance is recommended to be reduced to 60 to 70%.

Relation between Boring Dia. & MAX. Removal

MAX. Removal on Dia. (mm)



Recommended Cutting Condition (removal,feed)

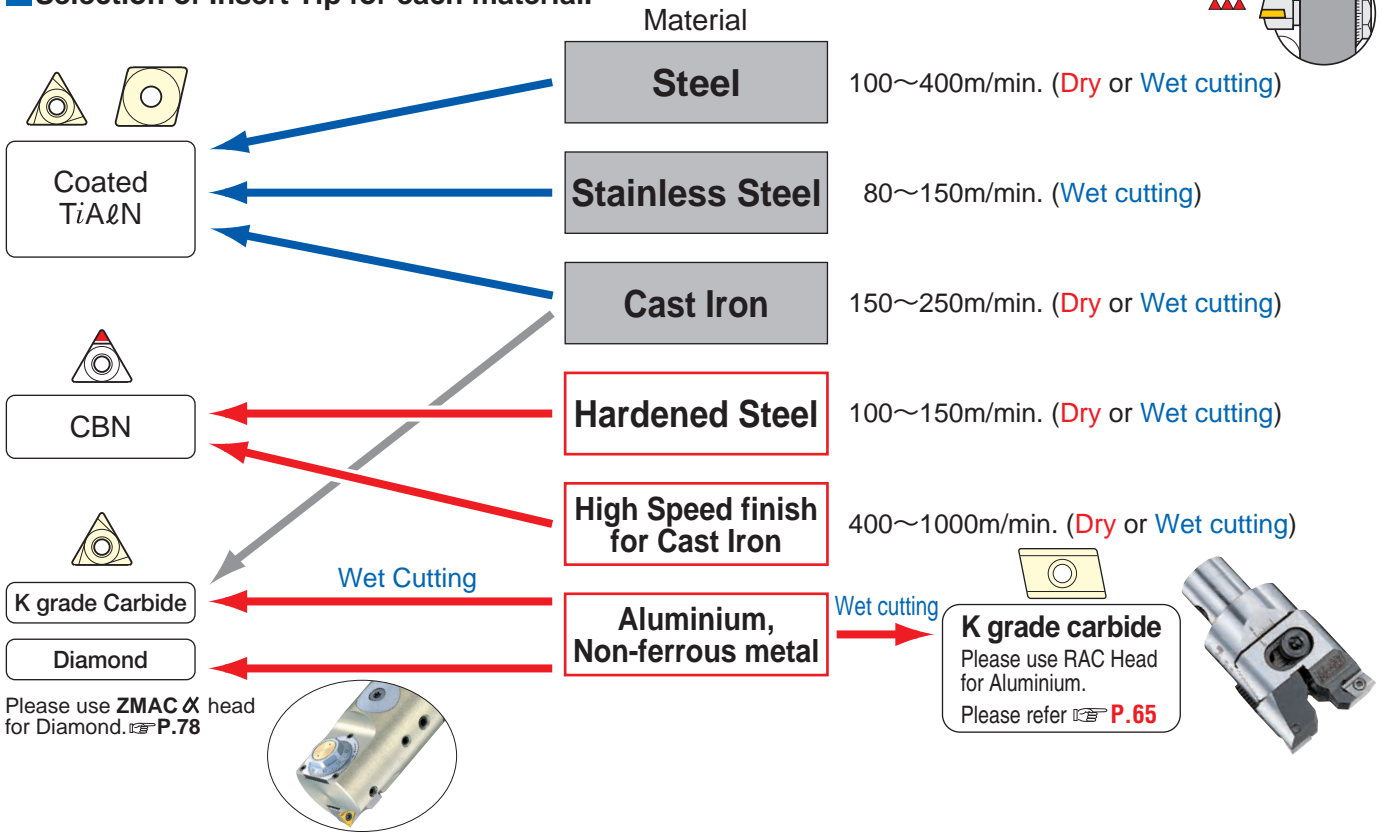
These figures are based on the application of L/D=3~3.5 times on cast iron.

Boring Range	Type	Best Condition		MAX. Condition	
		Removal mm/φ	Feed mm/rev.	Removal mm/φ	Feed mm/rev.
φ25~ 32	RAC 25	2.0~ 4.0	0.2~0.3	0.5~ 6.0	0.1~0.4
32~ 43	RAC 32	3.0~ 5.0	0.2~0.3	1.0~ 8.0	0.1~0.4
43~ 53	RAC 43	4.0~ 7.0	0.2~0.3	1.0~10.0	0.1~0.5
53~ 70	RAC 53	4.0~ 7.0	0.2~0.3	1.0~10.0	0.1~0.5
70~100	RAC 70	5.0~10.0	0.3~0.4	1.0~15.0	0.1~0.5
100~130	RAC100	7.0~12.0	0.3~0.4	1.0~22.0	0.1~0.5

ZMAC BORING SYSTEM CUTTING DATA



Selection of Insert Tip for each material.



Recommended cutting Speed ○...Best ○...Good ---...Unsuitable

Insert	Code No.	Grade	SS41	S55C	SCM	SKD	SC	FC,FCD	SUS	AL,ALC	Hardened Steel			Interrupted Cutting	
			SS41	S55C	SCM	SKD	SC	FC,FCD	SUS	AL,ALC	SCM	SKD	SUJ		
	C	Coated	100~400	150~400	150~400	80~150	80~150	150~250	80~150	-	-	-	-	○	
	E	P10	60~100	60~100	80~120	40~100	60~100	-	40~80	-	-	-	-	○	
	F	K10	-	-	-	-	-	60~130	-	400~1000	-	-	-	○	
	T	Cermet	200~400	200~400	200~400	80~150	80~150	-	120~180	-	-	-	-	○	
	B	CBN	-	-	-	-	-	300~800	-	-	-	100~150	70~100	120~150	○
	D	Diamond	-	-	-	-	-	-	-	400~2000	-	-	-	-	-
	C	Coated Carbide M	100~400	150~400	150~400	80~150	80~150	150~250	80~150	-	-	-	-	○	
		Coated Carbide K	100~400	150~400	150~400	80~150	80~150	150~250	80~150	-	-	-	-	○	

- ★Existing Inserts (Cermet, P grade Carbide & K grade Carbide) are available.
- ★The cutting speed is recommended to be reduced to 50% for the interrupted cutting.
- ★When L/D is longer, the insert tip with small Nose R is recommended.
- ★When L/D is longer, the feed rate at the entrance is recommended to be reduced to 60 to 70%.

Recommended Cutting Condition (removal, feed)

Boring Range	Type								
		Best Condition		MAX. Condition		Best Condition		MAX. Condition	
		Removal mm/φ	Feed mm/rev.	Removal mm/φ	Feed mm/rev.	Removal mm/φ	Feed mm/rev.	Removal mm/φ	Feed mm/rev.
φ16~20	ZMAC16	0.2~0.4	0.05~0.07	1.0	0.1				
φ20~25	ZMAC20	0.2~0.4	0.05~0.07	1.5	0.1				
φ25~32	ZMAC25	0.2~0.4	0.05~0.07	2.0	0.1				
φ32~42	ZMAC32	0.2~0.4	0.05~0.08	2.0	0.2	1.0~3.0	0.1~0.15	5.0	0.2
φ42~55	ZMAC42	0.2~0.5	0.05~0.08	4.0	0.2	1.0~3.0	0.1~0.15	5.0	0.2
φ55~70	ZMAC55	0.2~0.5	0.05~0.08	4.0	0.2	1.0~3.0	0.1~0.15	5.0	0.2
φ70~85	ZMAC70	0.2~0.8	0.05~0.1	4.0	0.25	1.0~4.0	0.1~0.2	8.0	0.25
φ85~	ZMAC85~	0.2~0.8	0.05~0.1	4.0	0.25	1.0~4.0	0.1~0.2	8.0	0.25

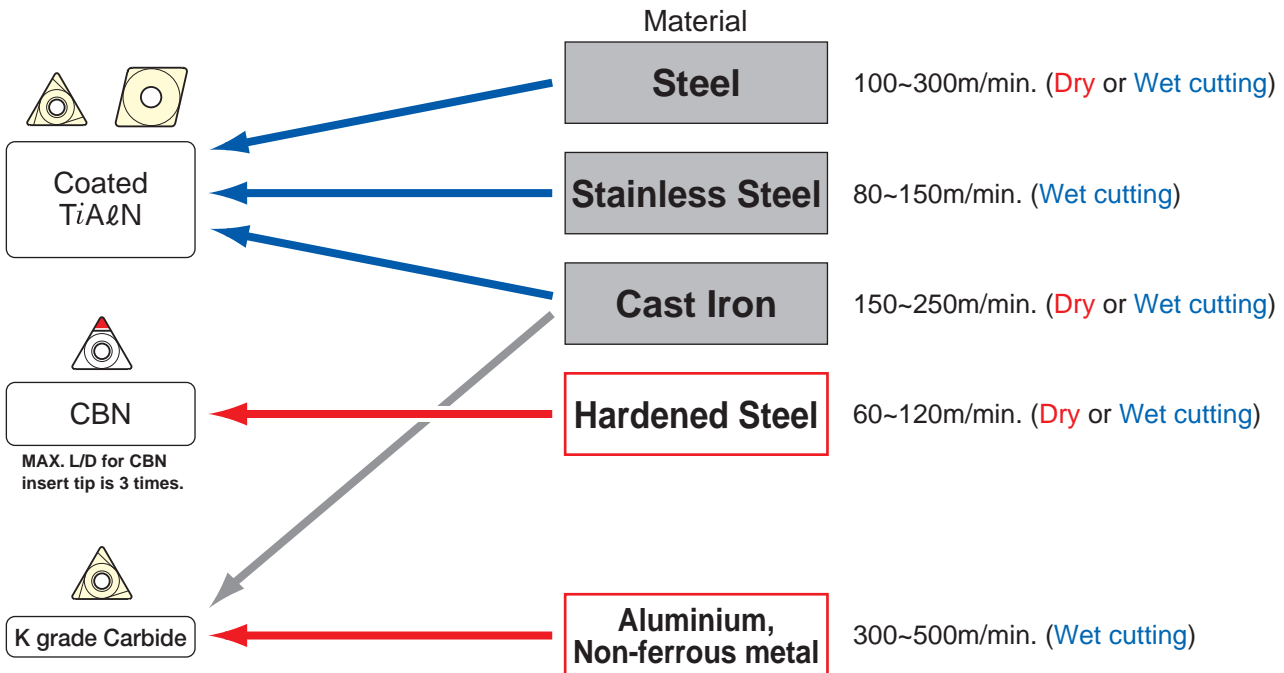
In case of CBN insert, reduce L/D as small as possible : MAX. 3 times.
 Stock removal on diameter.
 D<32mm : less than 0.25mm
 D>32mm : less than 0.3mm

Feed per rev. depends on Nose/R and accuracy required.
 Logical Surface Finish : $\frac{(\text{Feed per rev.})^2}{8 \times \text{Nose/R}}$

DJ BORING ARBOR CUTTING DATA



Selection of Insert Tip for each material.



Recommended cutting Speed ○...Best ○...Good -...Unsuitable

Insert	Code No.	Grade	SS41	S55C	SCM	SKD	SC	FC,FCD	SUS	AL,ALC	Hardened Steel			Inter-rupted Cutting
											SCM	SKD	SUJ	
	C	Coated	○	○	○	○	○	○	○	-	-	-	-	○
	E	P10	○	○	○	○	○	-	○	-	-	-	-	○
	F	K10	-	-	-	-	-	○	-	○	-	-	-	○
	T	Cermet	○	○	○	○	○	-	○	-	-	-	-	○
	B	CBN	-	-	-	-	-	-	○	-	-	○	○	○
	C	Coated	○	○	○	○	○	○	○	-	-	-	-	○

★Existing Inserts (Cermet,P grade Carbide & K grade Carbide) are available.
 ★The cutting speed is recommended to be reduced to 50% for the interrupted cutting.

Recommended Cutting Condition (removal,feed)

Boring Range	Type		Best Condition		MAX. Condition	
	DJ3	DJ8	mm/φ	mm/rev.	mm/φ	mm/rev.
φ 3~ 8	J10- 3		~0.1	0.03~0.07		
φ 5~ 15	J10- 5		0.1~0.2	0.05~0.07		
φ 8~ 18	J10- 8	J16- 8	0.1~0.2	0.05~0.08		
φ18~ 28	J10-18	J16-18	0.2~0.4	0.05~0.08	1.0	0.1
φ28~ 39		J16-28	0.2~0.4	0.05~0.08	1.5	0.15
φ38~ 50		J16-38	0.2~0.5	0.05~0.08	2.0	0.15

In case of CBN insert, reduce L/D as small as possible : MAX. 3 times.
 Stock removal on diameter.
 D<32mm : less than 0.25mm
 D>32mm : less than 0.3mm

Feed per rev. depends on Nose/R and accuracy required.

$$\text{Logical Surface Finish} = \frac{(\text{Feed per rev.})^2}{8 \times \text{Nose/R}}$$

NIKKEN INSERT TIP (EXCLUSIVE FOR BORING ARBOR) (1)



B1

Material	Steel	●	●		●	●							
	Stainless Steel	●	●		●								
	Cast Iron	●	●	●					●	●			
	Aluminium									●			
	High Speed finish for Cast Iron										●		
	Hardened Steel										●		
	High Speed finish for Aluminium											●	

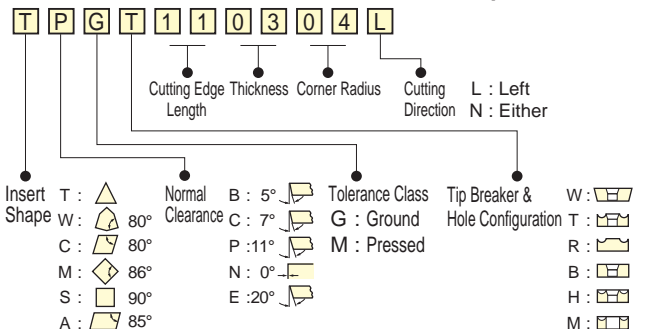
For the Boring of Large Diameter and Short Depth, the use of insert with large nose radius is recommended. The smaller nose radius inserts are ideal for smaller diameter boring or finishing operation.

Applicable Arbor	Dimension	Code No.	Grade	Coated Cermet		Coated Carbide M	Coated Carbide K	Cermet (w/o coating)	Carbide P	Carbide K	CBN	Diamond	
				PV90*1	T2000Z	AC630M	AC410K	NS530	TN90	ST10P	H1	KBN10B	KPD010
				NOSE R	C				T		E	F-NB*2 w/o breaker	F
BCB12.7, BCB14.5		1MP-○2	0.2	●	*1				●	●	●		
BCB19, BCB22, BCB29		3MS-○2	0.2	●	*1			●	●	●	*2	●	
ZMAC16, ZMAC20, ZMAC25 for DJ Bit		3MP-○2	0.2		●			●	●	●	*2	●	
		3MP-○4	0.4		●							●	
ZMAC32		4MP-○2	0.2		●			●	●	●	*2	●	
		4MP-○4	0.4		●							●	
ZMAC42 - ZMAC140 BCB38, BCB48 DJ Bit, MCCZ130 BAC130 - BAC530		6MP-○2	0.2	●	●			●	●	●	*2	●	
		6MP-○4	0.4	●	●			●	●	●	*2	●	
		6MP-○8	0.8	●	●			●	●	●	*2	●	
DAC C type BCB62, BCB82, BCB100		10MP-○2	0.2	●	*1				●	●	*2	●	
		10MP-○4	0.4	●	*1				●	●	*2	●	
		10MP-○8	0.8	●	*1				●	●	*2	●	
J10-5, J16-5		CC03-○2	0.2	●									
ZMAC32R, ZMAC42R, ZMAC55R		CC06-○4	0.4			●	●						
		CC06-○8	0.8			●	●						
RAC025		CC07-○4	0.4			●	●						
		CC07-○8	0.8			●	●						
ZMAC70R, ZMAC85R, RAC25, RAC32		CC08-○4	0.4			●	●						
		CC08-○8	0.8			●	●						
RAC43 - RAC530 (Eccentric Bolt Type)		CN08-○8	0.8			●							
ZMAC100R, ZMAC140R, RAC43E - RAC100E		CC12-○4	0.4			●	●						
		CC12-○8	0.8			●	●						

- ★Minimum quantity of CBN and Diamond: 1pcs, All other insert tip: 10pcs
- ★*1 "C (PV90)" is unified from "T".
- ★*2 "-NB" (w/o breaker) is recommended for cast iron.
- ★*3 Hole diameter of 6MP is $\phi 2.8$ mm. M2562D (Optional tip clamp bolt) is required for the ISO standard insert tip with the hole diameter of $\phi 3.3 \sim \phi 3.5$ mm.
- ★*4 M2562D is necessary for 6MP-D (Diamond), because of the hole diameter is different.
- ★The ISO code No. surrounded with () is the Nikken original insert tip.

Please add the grade indication into ○, and add the insert tip material indication at the end off the Code No.
e.g. 6MP-C4 (PV90) , 6MP-F4-NB (H1)

Code No. of ISO standard Insert Tip



NIKKEN INSERT TIP (EXCLUSIVE FOR BORING ARBOR) (2)



Material	Steel	●	●			
	Stainless Steel	●				
	Cast Iron			●		
	Aluminium			●		
High Speed finish for Cast Iron				●		
Hardened Steel				●		
		Cermet (w/o coating)	Carbide P	Carbide K	CBN	
		Grade	T	E	F	B
		Material NOSE R	T12A	ST10P	HTi10	KBN10B
Applicable Arbor	Dimension	Code No.				
BCB29		3P-○2	0.2	●	●	●
BCB38, BCB48		5P-○4	0.4	●	●	●
BCB62, BCB82		7P-○4	0.4	●	●	●
		7P-○8	0.8	●	●	●
BCB100		10P-○4	0.4	●	●	●
		10P-○8	0.8	●	●	●

★Minimum quantity of CBN: 1pcs, All other insert tip: 10pcs
 ★The ISO code No. surrounded with () is the Nikken original insert tip.

Please add the grade indication into ○, and add the insert tip material indication at the end off the Code No. e.g. 10P-T4 (T12A)

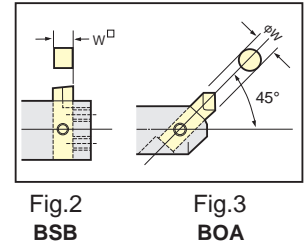
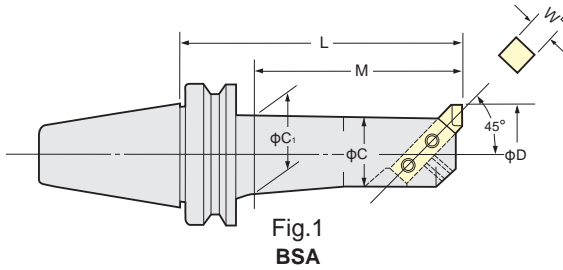
Grade & Material

Grade	Grade Indication	Insert Tip Material Indication	Specification
Coated Cermet	C	PV90	Applicable for the midium roughing and finishing on the steel. Very stable cutting with coolant to be improved the heat resistance and the impact resistance.
		T2000Z	ZX coated suitable for the high speed finishing on the steel with long insert life. Very fine surface finish to be improved the impact resistance and the fracture resistance.
		AC630M	Very tough carbide M (base material) with the super FF coated. Excellent for the impact resistance and the fracture resistance for the stainless steel
		AC410K	Very tough carbide K (base material) with the super FF coated. Very stable cutting for the ductile cast iron and normal cast iron.
Cermet (w/o coating)	T	TN90	Applicable for the roughing and finishing on the steel. Very stable cutting to be improved the heat resistance and the impact resistance.
		NS530	The general material for the steel and the cast iron with the heat resistance and the toughness.
		T12A	Applicable for the roughing and finishing on the steel. Very stable cutting to be improved the heat resistance and the impact resistance.
Carbide P	E	ST10P	Applicable for the middle to high speed cutting on the steel and the steel casting.
Carbide K	F	H1	Excellent wear resistance and applicable for the cast iron, non-ferrous metal and the non-metal.
		HTi10	Toughness and the excellent wear resistance. Applicable for the cast iron, non-ferrous metal and the non-metal.
		KW10	Stable wear resistance and the fracture resistance. Applicable for the cast iron, non-ferrous metal and the non-metal.K10
CBN	B	KBN10B	Excellent for the fracture resistance and wear resistance. Suitable for the high performance and high accuracy cutting on the harden steel
Diamond	D	KPD010	Suitable for the high speed cutting on the aluminium and the non-metal. Applicable for the cutting on the carbide, ceramics, glass fibere and the plastic also.

BORING BAR for SQUARE & CYLINDRICAL BORING TOOL



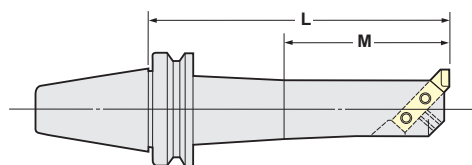
BSA BSB BOA



TAPER	Code No.	Boring Range	Boring Depth	Dimension				
	BTNo.-Min D -L	D	M	W	C	C ₁	Weight (kg)	Fig
No.40	BT40-BSA 25-135	25~ 38	108	8	20	22	1.3	Fig.1
	(IT40)-BSA 30-165	30~ 42	138		24	26	1.5	
	-BSA 38-180	38~ 52	153	10	30	33	1.8	
	-BSA 42-210	42~ 56	183		34	37	2.3	
	-BSA 50-180,225	50~ 65	153, 198	13	40	44	2.4, 2.9	
	-BSA 62-180,240	62~ 90	153, 218	16	50	56	3.2, 4.2	
	-BSA 72-180,240	72~110	153, 213	19	60	63	4.4, 5.7	
-BSA 90-180	90~125	180	75		5.4			
No.50	BT50-BSA 25-135	25~ 38	95	8	20	22	4.4	BSA
	(IT50)-BSA 30-165	30~ 42	125		24	26	4.6	
	-BSA 38-180	38~ 52	140	10	30	33	4.8	
	-BSA 42-210	42~ 56	170		34	37	5.0	
	-BSA 50-180,240	50~ 65	140, 200	13	40	44	5.4, 5.7	
	-BSA 62-195,270	62~ 90	155, 230	16	50	56	6.1, 7.5	
	-BSA 72-195,285	72~110	155, 245	19	60	66	6.9, 9.3	
-BSA 90-210,300	90~125	170, 260	75		80	9.2,12.3		
-BSA105-195,285	105~160	157, 247	25	90	90	10.5,15.0		
No.40	BT40-BSB 25-135	25~ 50	108	8	20	22	1.3	Fig.2
	(IT40)-BSB 38-180	38~ 70	153	10	30	33	1.9	
	-BSB 50-180,225	50~ 90	153, 198	13	40	44	2.6, 3.1	
	-BSB 62-180,225	62~115	153, 198	16	50	56	3.4, 4.1	
	-BSB 72-180,225	72~138	153, 198	19	60	63	4.7, 5.6	
-BSB 90-180,225	90~150	180, 225	75		5.7, 6.6			
No.50	BT50-BSB 25-135	25~ 50	95	8	20	22	4.1	BSB
	(IT50)-BSB 38-180	38~ 70	140	10	30	32	4.8	
	-BSB 50-180,240	50~ 90	140, 200	13	40	44	5.5, 5.7	
	-BSB 62-195,270	62~115	155, 230	16	50	56	6.4, 7.9	
	-BSB 72-195,285	72~138	155, 245	19	60	66	7.3, 9.6	
	-BSB 90-210,300	90~150	170, 260		75	80	9.6,12.6	
-BSB105-195,285	105~190	155, 245	25	90	94	11.0,15.0		
No.40	BT40-BOA 25-135	25~ 31	107	8	20	22	1.3	Fig.3
	(IT40)-BOA 30-165	30~ 35	137		24	26	1.5	
	-BOA 34-165	34~ 42	137	10	28	30	1.7	
	-BOA 40-180	40~ 46	152		32	35	2.3	
	-BOA 44-210	44~ 54	182	12	36	39	2.4	
-BOA 52-180,225	52~ 60	152, 197	42		46	2.5, 3.0		
No.50	BT50-BOA 25-135	25~ 31	97	8	20	22	4.2	BOA
	(IT50)-BOA 30-165	30~ 35	127		24	26	4.4	
	-BOA 34-180	34~ 42	142	10	28	30	4.7	
	-BOA 40-210	40~ 46	172		32	35	5.0	
	-BOA 44-210	44~ 54	172	12	36	39	5.1	
-BOA 52-180,240	52~ 60	142, 202	42		46	5.1, 6.0		

★Square or Cylindrical Boring Bit is not included.

★When L length is required longer than standard, please specify the boring depth M.



FACE MILL ARBOR (JIS)

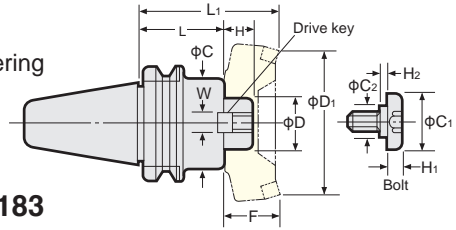


FMA

For JIS B4113 Face Mill

Taper contact area of more than 80% ensures reliable milling with no chattering accompanied

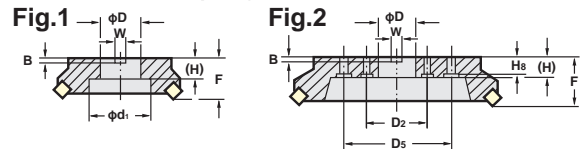
FMH Arbor for High Feed with Coolant Through P.151, P.183



TAPER	Code No. (ϕD -L)	Dimensions								Weight (kg)	Dimension of Arbor with cutter			Drive Key	Bolt
		H	C	W	C ₁	C ₂	H ₁	H ₂	L ₁		D ₁	F			
No.30	BT30-FMA25.4 - 45	22	50	9.5	33	23	10	2	1.3	95	80	50	FW 5	FM12	
No.40	BT40-FMA25.4 - 45	22	50	9.5	33	23	10	2	1.5	95	80	50	FW 5	FM12	
	(IT40)-FMA25.4 - 90								3.1	140			FW 5		
	-FMA31.75 - 45	30	60	12.7	40	23	10	6	1.7	105	100	60	FW13	FM16	
	-FMA31.75 - 75								3.1	135			FW13		
-FMA38.1 - 60	34	80	15.9	50	27	14	6	2.9	120	125	60	FW18	FM20		
No.50	BT50-FMA25.4 - 45	22	58	9.5	33	23	10	2	3.7	95	80	50	FW 5	FM12	
	(IT50)-FMA25.4 - 90								4.6	140			FW 5		
	-FMA25.4 -150								5.5	200					
	-FMA31.75 - 45								4.5	105	100	60	FW12	FM16	
	-FMA31.75 - 75	30	70	12.7	40	23	10	6	5.3	135			FW13		
	-FMA31.75 -105								6.1	165					
	-FMA38.1 - 45	34	80	15.9	50	27	14	6	4.3	105	125	60	FW18	FM20	
	-FMA38.1 - 75								5.6	135			FW19		
	-FMA50.8 - 45	36	100	19	65	37	14	10	4.9	105	160	60	FW23	FM24	
	-FMA50.8 - 75								6.8	135			FW24		
	-FMA47.625- 75	38	128.57	25.4	—	—	—	—	7.7	135	200	60	FW26	*	

- ★ Drive keys, L-Wrench & Bolt are supplied as standard.
- ★ The arbor marked * requires 4 fixing bolts.
- ★ Above weight is for Arbor only. (Not include Face Mill Cutter)
- ★ FMA25.4 type Arbor is suitable for NIKKEN PRO-END MILL $\phi 60$ (PE60HC) and $\phi 80$ (PE80HC).
- ★ FMA31.75 type Arbor is suitable for NIKKEN PRO-END MILL $\phi 100$ (PE100HC). Please refer P.103.
- ★ Code No. of Centre Through Coolant type FMA Arbor for NIKKEN PRO-END MILL is : e.g. BT40-FMA25.4C-45
- ★ Extended length Face Mill Arbors are available on request.
- BT50-FMA25.4 -200,-250
- FMA31.75-150,-200
- FMA38.1 -150,-200
- ★ Diameter ϕC of BT50-FMA25.4 and BT50-FMA31.75 are enlarged.

In case of the special cutter, please specify the dimensions below.

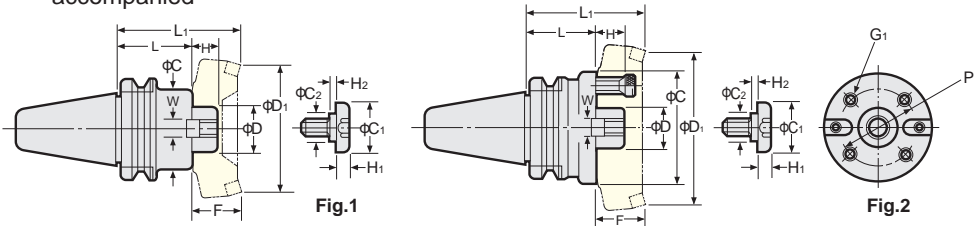


FACE MILL ARBOR



FMB

Taper contact area of more than 80% ensures reliable milling with no chattering accompanied



Inch Series

(●) figures for Metric Series

Metric Series

TAPER	Code No. (ϕD -L)	Dimensions										Weight (kg)	Dimension of Arbor with cutter			Fig.	Code No. (ϕD -L)	
		H	C	W	C ₁	C ₂	H ₁	H ₂	G ₁	P	L ₁		D ₁	F				
No.30	BT30-FMB25.4 - 45	26	80	9.5 (12)	33	23	10	2	—	—	1.7	95	80	50	1	BT30-FMB27 - 45		
No.40	BT40-FMB25.4 - 60	26	80	9.5 (12)	33	23	10	2	—	—	2.5	110	80	50	1	BT40-FMB27 - 60		
	(IT40)-FMB25.4 - 90											4.7	140				(IT40)-FMB27 - 90	
	-FMB38.1 - 60			85	15.9 (16)	50	27	14	6	—	—	7.4	123	125		63	-FMB40 - 60	
No.50	BT50-FMB25.4 - 45	26	80	9.5 (12)	33	23	10	2	—	—	4.0	95	80	50	1	BT50-FMB27 - 45		
	(IT50)-FMB25.4 - 90											5.8	140				(IT50)-FMB27 - 90	
	-FMB25.4 -150											8.2	200				-FMB27 -150	
	-FMB38.1 - 45											4.7	108	125		63	1	-FMB40 - 45
	-FMB38.1 - 75											6.1	138					
	-FMB38.1 -105												8.7	168				-FMB40 -105
	-FMB38.1F- 75			110	15.9 (16)	50	27	14	6	—	—	6.6	6.6	200		63	2	-FMB40F- 75
	-FMB60 - 75			25	140	25.4	—	—	—	—	—	7.9	7.9					

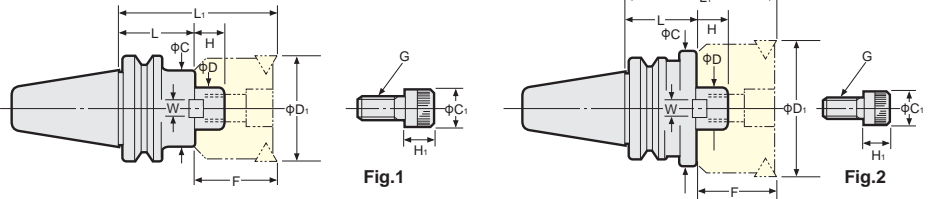
- ★ Drive keys, L-Wrench & Bolt are supplied as standard.
- ★ Above weight is for Arbor only. (Not include Face Mill Cutter)

SHOULDER CUTTER ARBOR

NIKKEN

FMC

Taper contact area of more than 80% ensures reliable Milling with no chattering accompanied.



TAPER	Dimensions				Weight (kg)	Dimensions of Arbor with cutter				C ₁	H ₁	Fig				
	Code No.(φD-L)	H	C	W		L ₁	D ₁	F	G CAP bolt							
No.30	BT30-FMC22- 40	18	45	10	1.4	80	50	40	M10×30	16	10	1				
	BT40-FMC22- 45	18	45	10	1.3	85	50	40	M10×30	16	10	1				
	(IT40)-FMC22- 90				2.0	130										
No.40	-FMC27- 60	20	60	12	1.5	110	80	50	M12×35	18	12	2				
	-FMC27- 90				2.2	140										
	-FMC32- 60	22	85	14	2.3	110	125	50	M16×35	30	16					
	-FMC32- 75				2.6	125										
	No.50	BT50-FMC22- 60	18	45	10	4.2	100	50	40	M10×30	16	10	1			
(IT50)-FMC22-105		4.7				145										
-FMC22-150		5.3				190										
-FMC27- 45		20	70	12	4.1	95	80	50	M12×35	18	12	1				
-FMC27- 90					5.5	140										
-FMC27-150					7.3	200										
-FMC32- 45		22	85	14	4.2	95	125	50	M16×35	30	16					
-FMC32- 75					5.5	125										
-FMC32-105					7.0	155										

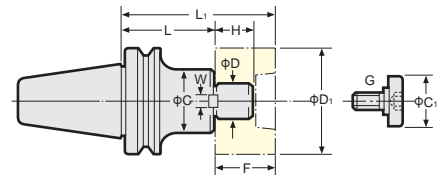
★ Drive keys, L-Wrench & Bolt are supplied as standard.
 ★ Above weight is for Arbor only. (Not include Face Mill Cutter)
 ★ FMC22 type Arbor is suitable for NIKKEN PRO-END MILL φ50 (PE50HC). P.103
 ★ Code No. of Centre Through Coolant type FMC Arbor for NIKKEN PRO-END MILL is e.g. BT40-FMC22C-45.

SHELL END MILL ARBOR

NIKKEN

SMS

Taper contact area of more than 80% ensures reliable Milling with no chattering accompanied.



TAPER	Code No.	Dimensions							Weight (kg)
		D	L	H	C	C ₁	W	G	
No.30	BT30-SMS16- 30	16	30	14	34	20	8	M 8	0.9
	-SMS22- 30	22		16	42	28	10	M10	1.0
	-SMS27- 45	27	45	18	50	33	12	M12	1.3
No.40	BT40-SMS16- 60	16	60	14	34	20	8	M 8	1.3
	(IT40)-SMS16-120		120						1.7
	-SMS22- 60	22	60	16	42	28	10	M10	1.4
	-SMS22-120		120						2.1
	-SMS27- 45	27	45	18	50	33	12	M12	1.4
	-SMS27-105		105						2.3
	-SMS32- 45	32	45	20	60	40	14	M16	1.6
-SMS32- 75	75		2.3						
No.50	BT50-SMS16- 75	16	75	14	34	20	8	M 8	4.2
	(IT50)-SMS16-120		120						5.8
	-SMS22- 75	22	75	16	42	28	10	M10	4.3
	-SMS22-120		120						4.8
	-SMS27- 60	27	60	18	50	33	12	M12	4.3
	-SMS27-105		105						5.2
	-SMS32- 45	32	45	20	60	40	14	M16	4.2
	-SMS32- 75		75						5.2
	-SMS40- 45	40	45	23	80	50	16	M20	4.3
	-SMS40- 75		75		70				5.5
-SMS50- 60	50	60	26	90	65	18	M24	6.3	

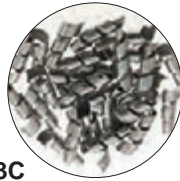
★ Drive keys, L-Wrench & Bolt are supplied as standard.
 ★ Above weight is for Arbor only. (Not include Face Mill Cutter)

PRO-END MILL for Precision Face Milling, Right Angle Shoulder Mill & High Speed Grooving.

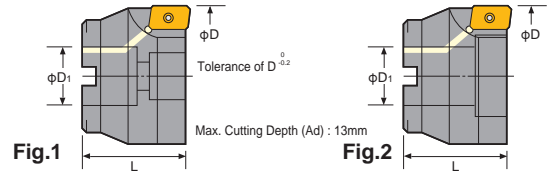
NIKKEN

PRO-END MILL

Suitable for NIKKEN FMA/FMC Arbor.

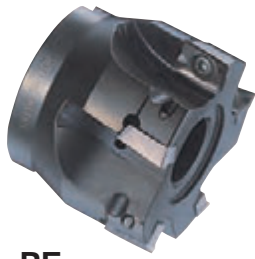


S53C



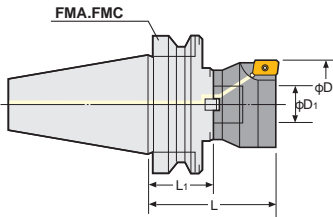
Code No.	D	D1	L	No. of Teeth	Insert Tip	Tip Clamp Bolt	Weight (kg)	Fig.
PE 50HC	50	22	45	5	Steel : 9DKT15	M 4090	0.4	1
PE 60HC	60	25.4	45	5			0.6	
PE 80HC	80	25.4	45	6	Aluminium, Cast Iron : 9DKR15	M 4012	0.8	2
PE100HC	100	31.75	50	6			1.6	

- ★Insert Clamp Bolt & Wrench are supplied as standard. ★Insert Tip is available as an option.
- ★Suitable for Face Mill Arbor FMA & FMC.
- ★Please add "C" after FMA/FMC for Centre Through Tool Coolant type. e.g. BT40-FMC22C-45
- ★The Lock Bolt is not supplied for PE50HC. Please use the bolt (M10x30) attached to FMC22.
- ★The Lock Bolt is supplied for PE60HC~PE100HC as standard.
- PE60HC: M12x35 PE80HC: 9PEM12-50 PE100HC: 9PEM16-55



PE

BT (IT) Shank Arbor for PRO-END MILL



TAPER	PRO-END MILL	PRO-END MILL Arbor	L	L1	D	D1
No.40	PE50HC	BT40-FMC22 -45,-90	90,135	45,90	50	22
	PE60HC, PE80HC	(IT40)-FMA25.4 -45,-90			60,80	25.4
	PE100HC	-FMA31.75-45,-75	95,125	45,75	100	31.75
No.50	PE50HC	BT50-FMC22 -60,-105	105,150	60,105	50	22
	PE60HC, PE80HC	(IT50)-FMA25.4 -45,-90			90,135	45,90
	PE100HC	-FMA31.75-45,-75	95,125	45,75	100	31.75

- ★Please add "C" after FMA/FMC for Centre Through Coolant type. e.g. BT40-FMC22C-45
- ★Please refer P.101 for FMC Arbor, FMA Arbor.

Code No.	Dimension	Grade	Material	Pro-END MILL	ISO Code No.	Tip Clamp Bolt	Tip Clamp Wrench
9DKT12		IC50M	Steel, Cast Iron	S20-PE22	APKT1203	M 3070	T-10
9DKT15			Steel	Except S20-PE22	ADKT1505	M 4090*1	PE-T15
9DKR15		IC28	Aluminum, Cast Iron		ADKR1505	M 4012	

- ★Please ask us if you require any other type of insert grade e.g. Coated, Cermet etc. For Heavy Cutting on Cast Iron, insert grade of IC520M is suitable.
- ★Purchase of Insert : box each (10 pcs.) ★*1 Please note there are two different kinds of Tip Clamp Bolts.

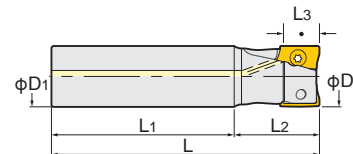
Straight Shank PRO-END MILL

NIKKEN



S-MDPE

NEW



Code No.	ϕD	D1	L	L1	L2	MAX. Cutting Depth L3	No. of Teeth	Insert Code No.	Tip Clamp Bolt	Tip Clamp Wrench	Weight (Kg)
S16-MDPE16-90	16	16	90	60	30	10	2	AOMT123608PEER-M	TPS-25	TIP07F	0.2
S20-MDPE20-100	20	20	100	70			3				0.2
S25-MDPE25-110	25	25	110	75	40	15	2	AOMT184808PEER-M	TPS-4	TIP15W	0.4
S32-MDPE32-120	32	32	120	80			3				0.7

- ★2 tip clamp bolts and tip clamp wrench are supplied as standard. ★Please refer P.219 for cutting condition.
- ★Insert tip is available as an option. P.171
- ★Coolant through tool is available as a standard for all series.

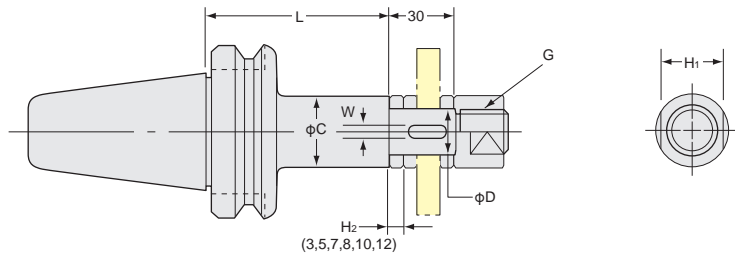
STUB ARBOR



■ Taper contact area of more than 80% ensures reliable milling with no chattering accompanied.



SCA



B1

Inch Series

(●) figures for Metric Series

Metric Series

TAPER	Code No.(φD-L)	H ₁	C	W	G	Weight (kg)	Code No.(φD-L)
No.30	BT30-SCA12.7 -60	17	20	—	M12	1.0	BT30-SCA13-60
	-SCA15.875-60	23	26	3.18 (4)	M14	1.1	-SCA16-60
	-SCA22.225-60	29	34	3.18 (6)	M20	1.2	-SCA22-60
	-SCA25.4 -60	32	40	6.35 (7)	M24	1.3	-SCA27-60
No.40	BT40-SCA12.7 -75,105	17	20	—	M12	1.2, 1.3	BT40-SCA13-75,105
	(IT40)-SCA15.875-75,105	23	26	3.18 (4)	M14	1.4, 1.5	(IT40)-SCA16-75,105
	-SCA22.225-75,120	29	34	3.18 (6)	M20	1.7, 2.0	-SCA22-75,120
	-SCA25.4 -75,120	32	40	6.35 (7)	M24	2.0, 2.4	-SCA27-75,120
	-SCA31.75 -90	41	46	7.92 (8)	M30	2.6	-SCA32-90
No.50	BT50-SCA12.7 -75,105	17	20	—	M12	4.0, 4.3	BT50-SCA13-75,105
	(IT50)-SCA15.875-90,120	23	26	3.18 (4)	M14	4.2, 4.4	(IT50)-SCA16-90,120
	-SCA22.225-90,135	29	34	3.18 (6)	M20	4.4, 4.7	-SCA22-90,135
	-SCA25.4 -90,135	32	40	6.35 (7)	M24	4.5, 4.9	-SCA27-90,135
	-SCA31.75 -90,135	41	46	7.92 (8)	M30	4.7, 5.2	-SCA32-90,135
	-SCA38.1 -90,135	46	55	9.52 (10)	M36	4.9, 5.9	-SCA40-90,135

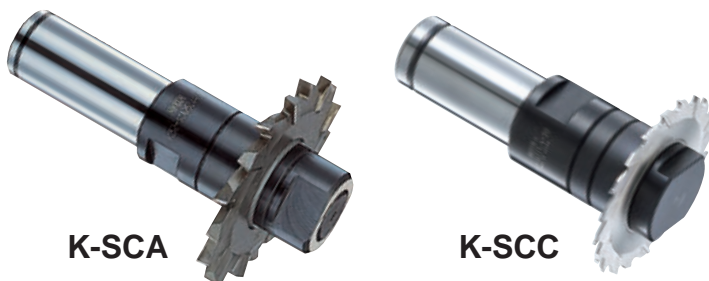
★JIS B4206, JIS B4107, JIS B4219, JIS B4109 cutters can be attached.
 ★Key and Collars (H₂=3, 5, 7, 8, 10, 12) are supplied as standard.
 ★The Code No. of Nut is unified from "GN" to "GNT".

Inch Series			Metric Series		
Arbor	Collar	Nut	Arbor	Collar	Nut
SCA12.7	G 1/2	GNT 1/2	SCA13	G13	GNT 1/2
15.875	G 5/8	GNT 5/8	16	G16	GNT 5/8
22.225	G 7/8	GNT 7/8	22	G22	GNT 7/8
25.4	G1	GNT1	27	G27	GNT1
31.75	G1 1/4	GNT1 1/4	32	G32	GNT1 1/4
38.1	G1 1/2	GNT1 1/2	40	G40	GNT1 1/2

★Please add the H₂ thickness at the end of Code No. for the collar. e.g. G1-8.

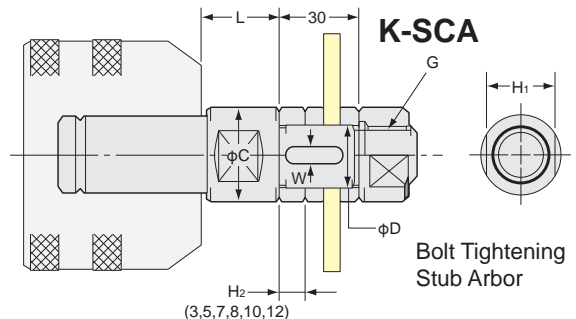
Straight Shank STUB ARBOR

■ For Multi-Lock Milling Chuck

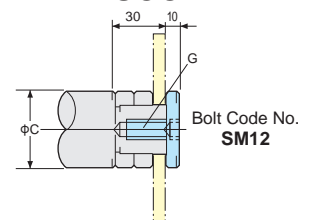


K-SCA

K-SCC



K-SCC



Style	K No. φD -L	H ₁	C	W	G	Weight (kg)
32	K32-SCA25.4-30	32	40	6.35	M24	1.2
	-SCC25.4-30				M12	1.2
42	K42-SCA25.4-30				M24	1.3
	-SCC25.4-30				M12	1.3

Thinner Bolt Head type is also available.

CENTRE THROUGH COOLANT TYPE HOLDER

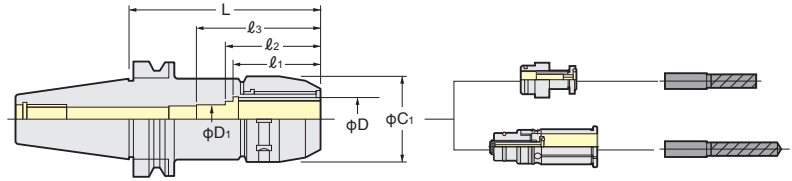
MAX.7MPa



MILLING CHUCK for Centre Through PAT.



Centre Through
MAX. 7MPa

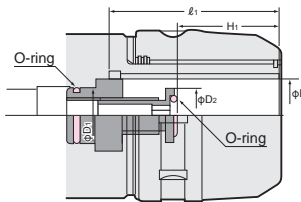


TAPER	Code No.	C ₁	D ₁	l ₁	l ₂	l ₃	Stopper	Collet	Weight (kg)
No.40	BT40 -C20C- 70, 90,105	52	20	58	66	80	9MC20H	CCK20 CCNK20	1.6, 1.8, 2.0
	(IT40) -C25C- 70, 90	60	25	61	72		9MC25H	CCK25 CCNK25	1.8, 2.1
	-C32C- 85,105,120	69		64,70,70	77,81,81	107	9MC32HS, 9MC32H, 9MC32H	CCK32 CCNK32	2.1, 2.5, 2.8
No.50	BT50 -C20C-105,135	52	20	58	66	80	9MC20H	CCK20 CCNK20	4.5, 4.9
	(IT50) -C25C-105,135	60	25	61	72		9MC25H	CCK25 CCNK25	4.8, 5.2
	-C32C- 90,105,135	69		70	81	107	9MC32H	CCK32 CCNK32	4.3, 4.6, 5.5
	-C42 - 95,105,135*	86	42	74	115	125	9MC42H	CCK42 CCNK42	5.5, 5.8, 7.1

Stopper for Direct Chucking

Direct Chucking means that chucking $\phi 32\text{mm}$ shank tool by $\phi 32\text{mm}$ ID Holder. If Tool's shank length longer than l_1 , Stopper is not necessary.

Chuck	Stopper	H ₁	C ₂
C20C	9MC20H	42~47	17
C25C	9MC25H	50~55	22
C32C	9MC32H	49~59	24
	9MC32HS	55~60	
C42	9MC42H	57~67	24



★Spanner is available as an option. C20 : 9HC22, C25 : 9HC25
C32 : 9HC32, C42 : 9HC42

★Shank of High Speed Milling Chuck (G) is **2LOCK**. (Centre through tool coolant is standard.) P.160 e.g. NBT40-C32-105G GH handle P.30 is necessary for High Speed Milling Chuck.

★Please note the acceptable shank tolerance is h7.

★Please refer P.32 for CCK Collet and CCNK Collet.

★Please add "RP" at the end of Code No. for Rust Proof Treatment Milling Chuck. e.g. BT40-C32C-85-RP.

★*C42 Milling Chuck is Centre Coolant Through type as standard.

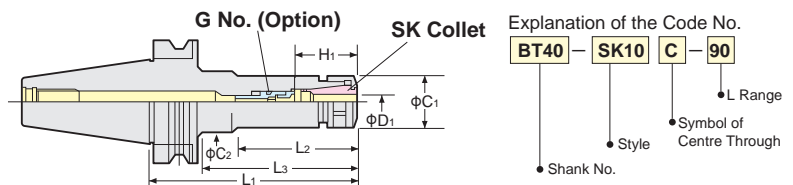
★Stopper for Direct Chucking is available as an option.

★In case of Heavy End Milling operation, please chuck the End Mill longer than l_1 without using Stopper.

SLIM CHUCK for Centre Through



Centre Through
MAX. 7MPa



TAPER	Code No.	D ₁	H ₁	L ₂	L ₃	C ₁	C ₂	G No. (Option)	Weight (kg)	SK Collet
No.40	BT40-SK 6C- 90,120	4~6	26~31	51,60	60,90	19.5	32,32	SKG6-6HG	1.1,1.4	SK 6
	(IT40)-SK10C- 90,120,150,180	5~10	33~41	48,73,73,73	60,90,118,148	27.5	40,40,34.5,39	SKG10-10HG	1.2,1.4,1.6,1.6	SK10
	-SK13C- 90,120,150,180	5~13	39~51	58,88,88,88	- ,118,148	33	- ,40,40	SKG13-10HG	1.4,1.6,1.8,1.8	SK13
	-SK16C- 90,120,150,180	10~16	45~57	58,88,118,148	-	40	-	SKG16-12HG	1.5,1.7,1.9,2.0	SK16
	-SK20C- 75, 90, 120	10~20	47~63	45,60,90	-	48.5	-	SKG20-18HG	1.4,1.6,2.0	SK20
	-SK25C- 90,120	16~25	60~65,60~70	61,91	-	55	-	SKG25-18HG,SKG25-24HG	1.8,2.0	SK25
No.50	BT50-SK 6C-105,165	4~6	26~31	55,60	64,114	19.5	32,32	SKG6-6HG	3.8,4.0	SK 6
	(IT50)-SK10C-105,135,165,200	5~10	33~41	57,70,75,75	- ,92,114,151	27.5	- ,32,32,36	SKG10-10HG	4.2,4.4,4.6,4.8	SK10
	-SK13C-105,135,165,200	5~13	39~51	62,92,92,92	- ,122,157	33	- ,45,45	SKG13-10HG	4.5,4.7,4.9,5.2	SK13
	-SK16C-105,135,165,200	10~16	45~57	62,92,90,90	- ,122,157	40	- ,50,52	SKG16-12HG	4.7,4.9,5.1,5.5	SK16
	-SK20C-105,135,165	10~20	47~63	62,92,122	-	48.5	-	SKG20-18HG	4.3,4.6,5.0	SK20
	-SK25C-105,165	16~25	60~70	62,122	-	55	-	SKG25-24HG	5.2,5.6	SK25

★Collet, adjust screw (G No.) and spanner are available as an option.

The Code No. of the spanner is **SK6C (C=φ18)** : SKL-6, SK6C (C=φ19.5) : SKL-6W, SK10C: SKL-10, SK13C: 9HC12A, SK16C: 9HC16, SK20C: 9HC22, SK25C: 9HC25

★Shank of High Speed Slim Chuck (P) is **2LOCK**. P.166 e.g. NBT40-SK10C-90P GH handle P.30 is necessary for High Speed Slim Chuck.

★Please add "RP" at the end of Code No. for Rust Proof Treatment Slim Chuck. e.g. BT40-SK10C-90-RP. ★Please refer P.39 for SK Collet.

★When cutter shank dia. is smaller than MIN. of D₁, special adjust screw (G No.) is required. P.44

CENTRE TROUGH COOLANT TYPE HOLDER

MAX.7MPa

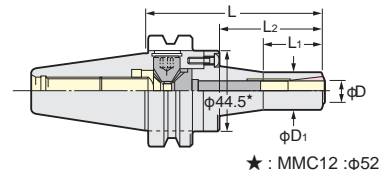


MINI-MINI CHUCK for Centre Through



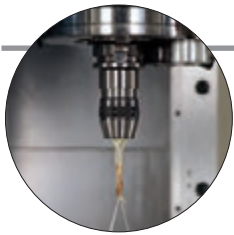
Centre Through
MAX. 7MPa

30,000min⁻¹ & G2.5
Gripping from Front Nose
Run-out Accuracy : Within 3μm



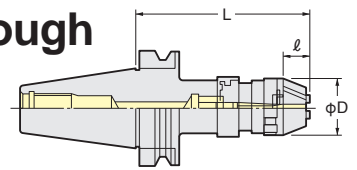
TAPER	Code No.	φD	φD ₁	L ₁	L ₂	Collet	MAX. (min ⁻¹)	Weight (kg)
No.40	BT40-MMC 8C- 90,120	2~ 8	20	36, 43	42, 72	VMK 8J	30,000	1.4, 1.5
	(IT40)-MMC12C- 90,120	4~12	30	35, 60	44, 74	VMK12J		1.7, 1.8
No.50	BT50-MMC 8C-105,135,165	2~ 8	20	36, 43, 43	42, 72, 102	VMK 8J	20,000	4.4, 4.5, 4.6
	(IT50)-MMC12C-105,135,165	4~12	30	35, 60, 70	44, 74, 104	VMK12J		4.6, 4.7, 4.8

★Wrench is supplied as standard. Collet is available as an option P.33.
★Please use VMK Collet for the cutter with oil hole, and use VMK-J Collet for the cutter without oil hole. P.33
★Photo shows MINI-MINI Chuck & VMK Collet chucking with φ2.7mm oil hole drill.



NPU DRILL CHUCK for Centre Through

(MAX. 1MPa)



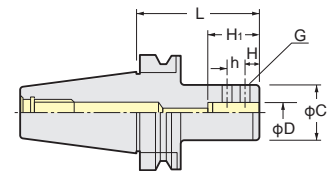
TAPER	Code No.	φDmm	φD	ℓ	L	Weight (kg)
No. 40	BT40-NPU13C- 80	6~ 13	48.5	26.5	92.1~103.1	1.5
	(IT40) 130				137.1~148.1	2.2
	175				182.1~193.1	2.7
No. 50	BT50-NPU13C- 90	6~ 13	48.5	26.5	97.1~108.1	4.1
	(IT50) 130				137.1~148.1	4.6
	190				197.1~208.1	5.2

★Wrench is available as an option. NPU8: NPUL-8, NPU13: NPUL-13.
★MIN. Chucking Dia. for center through coolant is φ6mm. ★Please use Slim Chuck for high pressure coolant 7MPa. P.103



SIDE LOCK HOLDER (for DRILL) for CentreThrough

Centre Through
MAX. 7MPa



TAPER	Code No.	D	L	C	h	H	H ₁	G	Collet	Weight (kg)
No. 40	BT40-SL20C- 90	20	90	50	16	12	44.5	M10	—	1.8
	(IT40)-SL25C- 90	25		55	17	14	54.5	M12 P1.25	OK25	1.7
	-SL32C- 90	32		60	16	15	59.5	M12 P1.25	OK32	1.9
No. 50	BT50-SL20C-105	20	105	50	16	12	44.5	M10	—	4.8
	(IT50)-SL25C-105	25		55	17	14	54.5	M12 P1.25	OK25	4.7
	-SL32C-105	32		60	16	15	59.5	M12 P1.25	OK32	4.9
	-SL40C-105	40		88	19	18	70	M12 P1.25	OK40	5.2

★For OK 25, OK 32 and OK 40 Collet, please refer P.103.

RPT (RUST PROOF TREATMENT)



Rust Proof Treatment (Option)

The RPT treatment creates a fine film of the contents (Fe₃O₄) and (Fe₂O₃), and penetrates into the tool holder material 1~2 micron deep. This fine film inhibits the rust and corrosion of your tool holder taper and stops it from being transmitted to your machine spindle. The RPT treatment will not effect the accuracy and the hardness of your NIKKEN tool holders.

⚠ Caution

- If the detection of tool existing at tool magazine by optical method on your M/C, the tool with RPT treatment may be judged "no tool existing". Please check your M/C specification.
- The taper connection of the tool shank with RPT treatment is more stuck than the taper connection of the tool shank without RPT treatment. Then, the unclamping force for the tool with RPT is required 20% stronger than the unclamping force for the tool without RPT. Please be careful to check the unclamping force of your M/C, when the tool with RPT treatment is chosen.
- Therefore, the taper cone of 3LOCK tool and NC5 tool is changed to without RPT treatment as standard. When the taper cone with RPT treatment is required, please add "TCRP" at the end of Code No.

Standard
8 years used

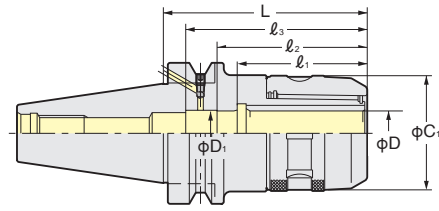
RPT
18 years used



FLANGE THROUGH COOLANT TYPE HOLDER



MILLING CHUCK for Flange Through PAT.



TAPER	Code No.	C ₁	D ₁	l ₁	l ₂	l ₃	Stopper	Collet	Weight (kg)
No.40	BT40 -C20F- 90,105	52	20	58	66	80	9MC20H	CCK20 CCNK20	1.9, 2.0
	(IT40) -C25F- 90,105	60	25	61	70		9MC25H	CCK25 CCNK25	2.0, 2.2
	-C32F-105,120	69		70	81	107	9MC32H	CCK32 CCNK32	2.5, 2.8
No.50	BT50 -C20F-105,135,165	52	20	58	66	80	9MC20H	CCK20 CCNK20	4.2, 4.4, 4.8
	(IT50) -C25F-105,135,165	60	25	61	72		9MC25H	CCK25 CCNK25	4.5, 5.1, 5.7
	-C32F-120,135,165	69		70	81	107	9MC32H	CCK32 CCNK32	5.1, 5.5, 6.4
	-C42F-120,135,165	86	42	105, 115, 115	125	9MC42H	CCK42 CCNK42	5.8, 6.1, 6.8	

★Spanner is available as an option. C20 : 9HC22, C25 : 9HC25
C32 : 9HC32, C42 : 9HC42



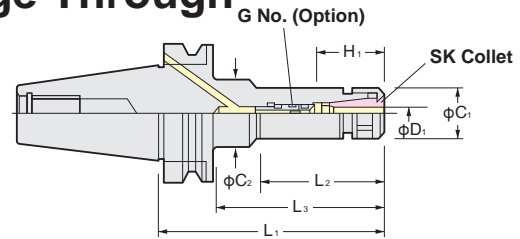
★Shank of High Speed Milling Chuck (G) is **2LOCK**. e.g. NBT40-C20F-105G
GH Handle P.30 is necessary for High Speed Milling Chuck.

★Please refer P.32 for CCK Collet and CCNK Collet. ★In case of Heavy End Milling operation, please chuck the End Mill longer than l₁ without using stopper. P.105

★Please add "RP" at the end of Code No. for Rust Proof Treatment Milling Chuck. e.g. BT40-C20F-75-RP. ★Please note the acceptable shank tolerance is h7.



SLIM CHUCK for Flange Through



TAPER	Code No.	D ₁	H ₁	L ₂	L ₃	C ₁	C ₂	G No. (Option)	Weight (kg)	Collet
No.40	BT40-SK 6F- 90,120	4~6	26~31	51,60	60,90	19.5	32,32	SKG6-6HG	1.1,1.4	SK 6
	(IT40)-SK10F- 90,120,150,180	5~10	33~41	48,73,73,73	60,90,118,148	27.5	40,40,34.5,39	SKG10-10HG	1.2,1.4,1.6,1.6	SK10
	-SK13F- 90,120,150,180	5~13	39~51	58,88,88,88	-,-,118,148	33	-,-,40,40	SKG13-10HG	1.4,1.7,1.8,1.8	SK13
	-SK16F- 90	10~16	45~50	58	-	40	-	SKG16-12HGB	1.5	SK16
	-120,150,180		45~57	88,118,148				SKG16-12HG	1.7,1.9,2.0	
	-SK20F- 90,120	10~20	57~63,47~63	60,90	-	48.5	-	SKG20-18HGB,SKG20-18HG	1.4,2.0	SK20
-SK25F- 90,120	16~25	50~58,55~65	61,91	-	55	-	SKG25-18HGC,SKG25-24HGA	1.8,2.0	SK25	
No.50	BT50-SK 6F-105,165	4~6	26~31	55,60	64,114	19.5	32,32	SKG6-6HG	3.8,4.0	SK 6
	(IT50)-SK10F-105,165,200,225	5~10	33~41	57,75,75,75	-,114,151,178	27.5	-,32,36,40	SKG10-10HG	4.2,4.6,4.8,5.1	SK10
	-SK13F-105,165,200	5~13	39~51	62,92,92	-,122,157	33	-,45,45	SKG13-10HG	4.5,4.9,5.2	SK13
	-SK16F-105,165,200	10~16	45~57	62,90,90	-,122,157	40	-,50,52	SKG16-12HG	4.7,5.1,5.5	SK16
	-SK20F-105,165	10~20	47~63	62,122	-	48.5	-	SKG20-18HG	4.3,5.0	SK20
	-SK25F-105,165	16~25	55~65,55~70	62,122	-	55	-	SKG25-24HGA,SKG25-24HG	5.2,5.6	SK25

★Collet, adjust screw (G No.) and spanner are available as an option.

The Code No. of the spanner is **SK6F (C=φ18)** : SKL-6, SK6F (C=φ19.5) : SKL-6W, SK10F : SKL-10, SK13F : 9HC12A, SK16F : 9HC16, SK20F : 9HC22, SK25F : 9HC25

★Shank of High Speed Slim Chuck (P) is **2LOCK**. e.g. NBT40-SK10F-90P GH Handle P.30 is necessary for High Speed Slim Chuck.

★Please add "RP" at the end of Code No. for Rust Proof Treatment Slim Chuck. e.g. BT40-SK10F-90-RP.

★Please refer P.39 for SK Collet.

★When cutter shank dia. is smaller than MIN. of D₁, special adjust screw (G No.) is required. P.44



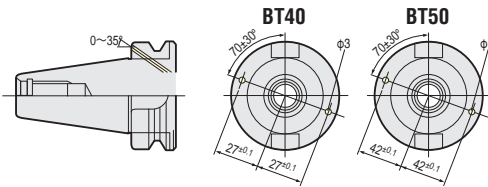
- The special pull stud with Oring is required for the M/C with flange through coolant capability.
- When the stroke of the coolant nozzles at the spindle flange on the M/C with flange through coolant capability is shorter, it may be a collision between flange of **2LOCK** tool and the nozzles. Please check the specification on your M/C.

FLANGE THROUGH COOLANT TYPE HOLDER



High Pressure Coolant Through Flange

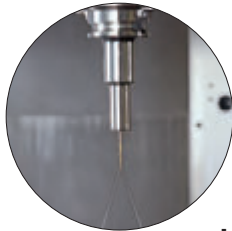
The Flange Through Coolant System is a solution against the spindle rust and the dust problems of Centre Through Coolant System. These Tool Holder are used for Machine has Flange Through Holes and standard as **DIN69871/B**.



NISHIDA **BT40** Machine's Flange Through Hole alignment is unique. Option **(T)** is available. Specify as **BT40-C20T-90**

RPT (Rust Proof Treatment) P.106

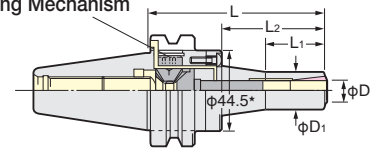
Pull Stud (with O-ring) for Flange Through type is also available.



MINI-MINI CHUCK for Flange Through

30,000min⁻¹ & G2.5
Gripping from Front Nose
Run-out Accuracy: Within 3µm

New Locking Mechanism



High Speed

★ : MMC12 : φ52.4

TAPER	Code No.	φD	φD1	L1	L2	Collet	MAX. min ⁻¹	Weight (kg)
No.40	BT40-MMC 8F- 90, 120	2~ 8	20	33, 40	42, 72	VMK 8J	30,000	1.4, 1.5
	(IT40)-MMC12F- 90, 120	4~12	30	36, 60	44, 74	VMK12J		1.7, 1.8
No.50	BT50-MMC 8F-105, 135, 165	2~ 8	20	33, 40, 40	42, 72, 102	VMK 8J	20,000	4.4, 4.5, 4.6
	(IT50)-MMC12F-105, 135, 165	4~12	30	36, 60, 70	44, 74, 104	VMK12J		4.6, 4.7, 4.8

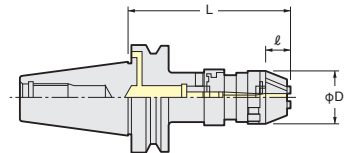
★Wrench is supplied as standard. Collet is available as an option P.33.

★Please use VMK Collet for the cutter with oil hole, and use VMK-J Collet for the cutter without oil hole.

★Photo shows MINI-MINI Chuck & VMK Collet chucking with φ2.7mm oil hole drill.



NPU DRILL CHUCK for Flange Through



TAPER	Code No.	φDmm	φD1	ℓ	L	Weight (kg)
No.40	BT40-NPU13F-105	6~ 13	48.5	26.5	112.1~123.1	1.9
	(IT40) 150				157.1~168.1	2.4
No.50	BT50-NPU13F-110	6~ 13	48.5	26.5	117.1~128.1	4.4
	(IT50) 150				157.1~168.1	4.8

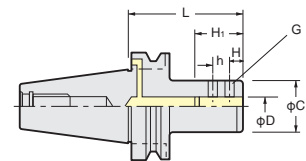
★Wrench is available as an option. NPU8: NPUL-8, NPU13: NPUL-13.

★Please use Slim Chuck P.107 for high pressure coolant (MAX. 7Mpa).

★MIN. Chucking Dia. for center through coolant is φ6mm.



SIDE LOCK HOLDER (for DRILL) for Flange Through



TAPER	Code No.	D	L	C	h	H	H1	G	Collet	Weight (kg)
No. 40	BT40-SL20F- 90	20	90	50	16	12	44.5	M10	—	1.8
	(IT40)-SL25F- 90	25	90	55	17	14	54.5	M12 P1.25	OK25	1.7
	-SL32F- 90	32	90	60	16	15	59.5	M12 P1.25	OK32	1.9
No. 50	BT50-SL20F-105	20	105	50	16	12	44.5	M10	—	4.8
	(IT50)-SL25F-105	25	105	55	17	14	54.5	M12 P1.25	OK25	4.7
	-SL32F-105	32	105	60	16	15	59.5	M12 P1.25	OK32	4.9
	-SL40F-105	40	105	88	19	18	70	M12 P1.25	OK40	5.2

★For OK25, OK32 and OK40 Collet, please refer P.111.

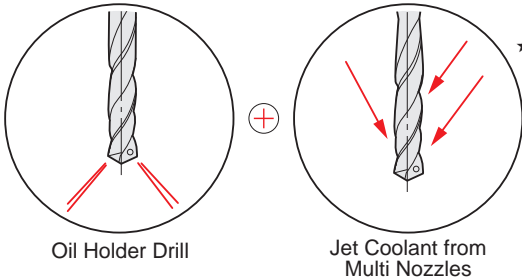
BT

MULTI OIL HOLE HOLDER (1)



Internal and External Coolant Feeding Switchable

Internal Coolant Feeding is done with Oil Holder Drill and External Coolant Feeding from Multi Nozzles exactly hit the cutting point in jet streams, when drill, end mill, tap, and reamer without oil hole are used switching of Internal and External Feeding can be done in one touch.



Oil Holder Drill

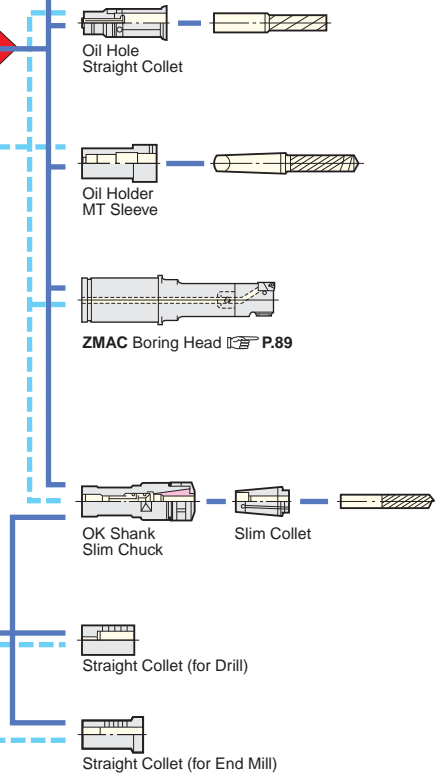
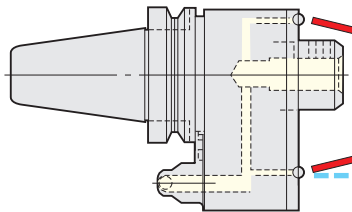
Jet Coolant from Multi Nozzles

Varieties of Attachment P.111



★For High Precision Machining, MOC or MOK is recommended.

JET Coolant direction adjustable

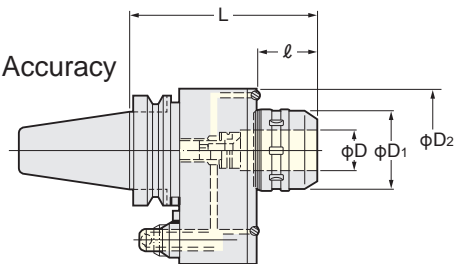
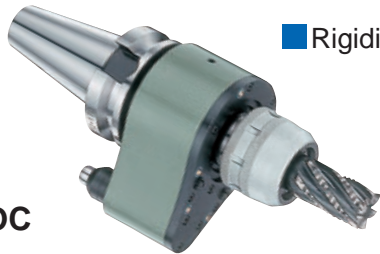


Conventional Oil Hole Holder (Internal Coolant Feeding) CO, SLO, MTO, SKO are also available. P.111

Milling Chuck type Multi Oil Hole Holder

Rigidity · Gripping Power · Accuracy

MOC



D₂ :
BT40 : 85
BT50 : 110

MAX. Coolant Pressure: 2.5MPa

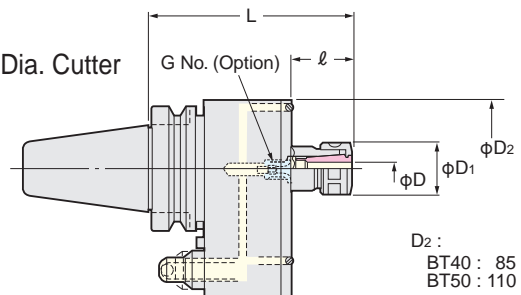
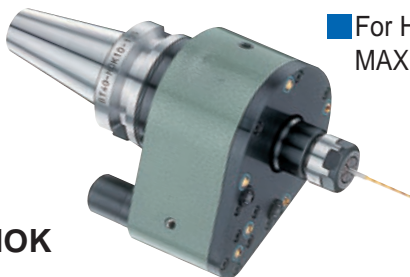
TAPER	Code No. -L	D	ℓ	D ₁	MAX.min ⁻¹	Weight (kg)	Applicable Collet
No.40	BT40-MOC20-145	20	49	52	4,000	3.6	CCK20 CCNK20
	(IT40)-MOC32-160	32	69	69	3,500	4.4	CCK32 CCNK32 OK32-MT K32-Q
No.50	BT50-MOC20-160	20	44	52	4,000	7.0	CCK20 CCNK20
	(IT50)-MOC32-170	32	54	69	3,500	7.1	CCK32 CCNK32 OK32-MT K32-Q

★For Collet and Adapter, please refer P.111. ★K32-Q : Straight Shank for Modular type. P.87 ★IT40-MOC20-155 and IT40-MOC32-170 are also available.
★Stopper block is available as an option. When ordering, please inform your M/C maker and Model as well as your M/C spindle flange dimension.

Slim Chuck type Multi Oil Hole Holder

For High Speed Rotation of Small Dia. Cutter
MAX.6,000min⁻¹

MOK



D₂ :
BT40 : 85
BT50 : 110

MAX. Coolant Pressure: 2.5MPa

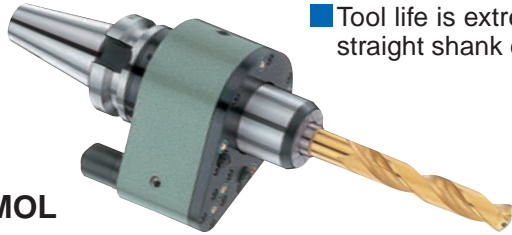
TAPER	Code No. -L	D	ℓ	D ₁	MAX.min ⁻¹	Weight (kg)	Collet	G No. (Option)
No.40	BT40-MOK10-135	5~10	39	27.5	6,000	3.2	SK10	SKG10-10HGF
	(IT40)-MOK16-150	10~16	54	40	5,500	3.5	SK16	SKG16-12HGF
No.50	BT50-MOK10-150	5~10	34	27.5	6,000	6.8	SK10	SKG10-10HGF
	(IT50)-MOK16-165	10~16	49	40	5,500	7.1	SK16	SKG16-12HGF

★Nut is supplied as standard. ★Adjust Screw (G No.) P.44 and spanner are available as an option. MOK10: SKL-10, MOK16: 9HC16
★For Slim Collet, please refer P.39. ★Stopper block is available as an option. When ordering, please inform your M/C maker and Model as well as your M/C spindle flange dimension.

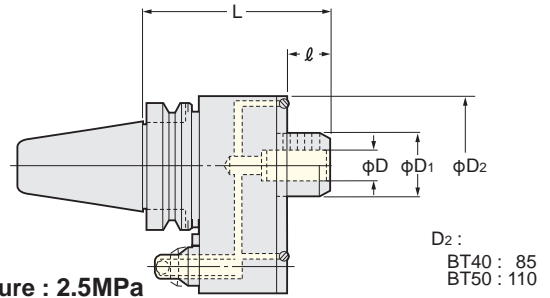
MULTI OIL HOLE HOLDER (2)



Side Lock type Multi Oil Hole Holder



- Tool life is extremely extended in straight shank drill.



MAX. Coolant Pressure : 2.5MPa

TAPER	Code No.	-L	D	ℓ	D ₁	MAX.min ⁻¹	Weight (kg)	Collet
No.40	BT40-MOL16-130		16	34	34.5	5,500	3.1	—
	(IT40)-MOL20-130		20		44	4,000	3.5	—
	MOL25-130		25		49	3,500	3.8	OK25-16, 20
	-MOL32-135		32	39	49	3,500	3.8	OK32-16, 20, 25
No.50	BT50-MOL16-150		16	34	34.5	5,500	7.0	—
	(IT50)-MOL20-150		20		44	4,000	7.5	—
	-MOL25-150		25		49	3,500	7.8	OK25-16, 20
	-MOL32-150		32	49	3,500	7.8	OK32-16, 20, 25	
	-MOL40-160		40	44	59	3,000	8.0	OK40-32

★For Collet, please refer P.111.

★IT40-MOL16-140, IT40-MOL20-140, IT40-MOL25-140 and IT40-MOL32-145 are also available.

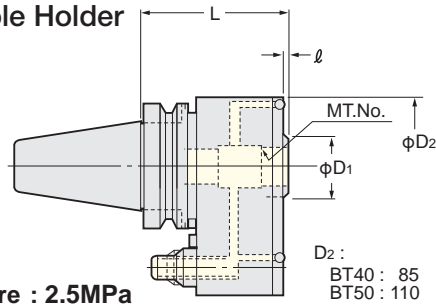
★Stopper block is available as an option. When ordering, please inform your M/C maker and Model as well as your M/C spindle flange dimension. P.266

Morse Taper type Multi Oil Hole Holder

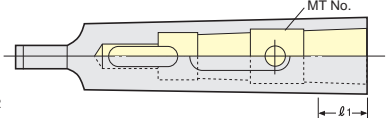


MOM

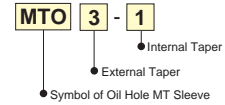
MAX. Coolant Pressure : 2.5MPa



MTO MT Shank MT Sleeve



Explanation of the Code No.



TAPER	Code No.	-L	MT	ℓ	D ₁	MAX.min ⁻¹	Weight (kg)	Sleeve
No.40	BT40-MOM3- 95		3	0	—	5,500	2.6	MTO3-1, 2
	(IT40)-MOM4-105		4	17	44	4,000	2.6	MTO4-1, 2, 3
No.50	BT50-MOM3-113		3	0	—	5,500	6.3	MTO3-1, 2
	(IT50)-MOM4-120		4	4	44	4,000	6.8	MTO4-1, 2, 3
	-MOM5-120		5	4	59	3,000	6.8	—

★For Socket, please refer P.111.

★IT40-MOM3-105 and IT40-MOM4-115 are also available.

★() in sleeve shows ℓ₁.

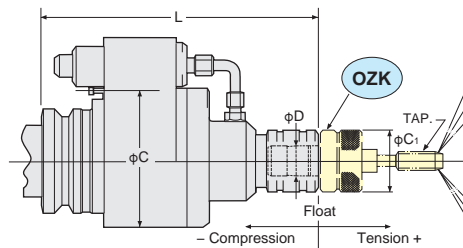
★Stopper block is available as an option. When ordering, please inform your M/C maker and Model as well as your M/C spindle flange dimension. P.266

Auto Depth Control Tapper Chuck for Oil Hole Tap



OZL

- To be used with Oil Hole Tap.
- Tapping depth is precisely controlled.
- MAX. 2,000min⁻¹, MAX. Coolant Pressure : 1.5MPa



OZK Tap Collet for OZL



TAPER	Code No.	-L	Tapping Capability			D	Float		C	C ₁	Weight (kg)	Tap Collet
			M	U	P		Compression	Tension				
No.40	BT40-OZL12-170		M 2~12	1/8~1/2	P 1/16~1/4	19	5	4	82	38.5	4.8	OZK12
	(IT40)-OZL24-205		M 8~24	1/2~1	P 1/4~5/8	30	6	7	98	56	5.3	OZK24
No.50	BT50-OZL12-185		M 2~12	1/8~1/2	P 1/16~1/4	19	5	4	98	38.5	8.5	OZK12
	(IT50)-OZL24-210		M 8~24	1/2~1	P 1/4~5/8	30	6	7	98	56	9.0	OZK24
	-OZL38-240		M18~38	3/4~1 3/8	P 3/8~1	45	8	10	115	78	10.0	OZK38

★Stopper block is available as an option. When ordering, please inform your M/C maker and Model as well as your M/C spindle flange dimension. P.266

BT

OIL HOLE HOLDER



SLO Side Lock type
SKO Slim Chuck type

Slim Chuck type for BT40/50 is Multi Oil Hole type (MOK), please refer P.109.

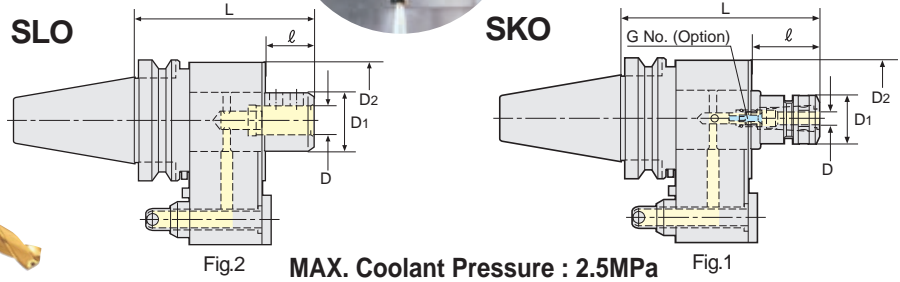
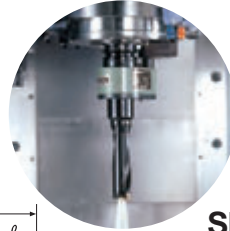


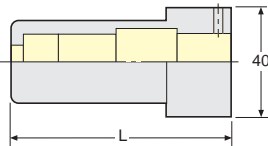
Fig.2 MAX. Coolant Pressure : 2.5MPa Fig.1

Oil Mist type holder which is not necessary to use coolant is also available for health and safety environment regulation. Please contact with us. e.g. BT40-SLO25M-130

TAPER	Code No.	L	D	ℓ	D ₁	D ₂	MAX.min-1	Weight (kg)	Collet	Fig.
No.30	BT30-SKO10-135B,135,125KA		5~10	18,41,43	27.5	63	6,000	1.8	SK10	1
	-SKO16-140B,145,130KA		10~16	23,51,48	40		5,500	2.1	SK16	
	-SKO25-145B,145,130KA		16~25	28,48,48	55	80	3,000	2.8	SK25	
No.40	BT40-SLO16-130		16	39.5	49	82	3,000	3.5	-	2
	(IT40)-SLO20-130		20		54				OK25	
	-SLO25-130		25		OK32					
	-SLO32-140		32		41.5				54	
No.50	BT50-SLO16-150		16	40	49	98	3,000	7.5	-	2
	(IT50)-SLO20-150		20		54				OK25	
	-SLO25-150		25		OK32					
	-SLO32-150		32		64				OK32	
	-SLO40-160		40		50				64	

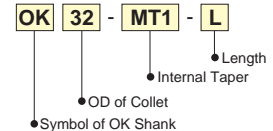
★BT-30-SKO added "B" (e.g. BT-30-SKO10-135B) is for BROTHER. BT30-SKO added "KA" (e.g. BT30-SKO10-125KA) is for KIRA.
 ★IT40-SLO16-140, IT40-SLO20-140, IT40-SLO25-140 and IT40-SLO32-140 are also available.
 ★For SKO Slim Chuck, Adjust Screw (G No.) is available as an option. P.44 SKO10: SKG10-10HGF, SKO16: SKG16-12HGF, SKO25: SKG25-18HGF
 ★For Heavy Duty Model with strong oil seals, please add the letter "HD" to the Code No. e.g. BT40-SLO25-130HD Ideal for ceramic material component.
 ★Please refer P.111 for OK25 and OK32 Collet for SLO type. ★Nut, Adjust Screw and Collet Extractor are included for SKO type as standard. Please refer P.39 for Slim Chuck Collet.
 ★Stopper block is available as an option. When ordering, please inform your M/C maker and Model as well as your M/C spindle flange dimension.

OK Shank MT Sleeve for MOL and SLO

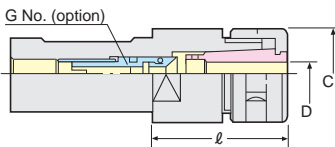


OK-MT Sleeve Code No.
OK32-MT1-85, MT2-85, MT3-100

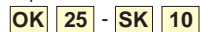
Explanation of the Code No.



OK Shank Slim Chuck for MOL and SLO



Explanation of the Code No.

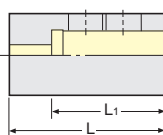


OK 25 - SK 10
 • Symbol of OK Shank
 • OD of Shank
 • Slim Chuck
 • MAX. Chucking Dia.

Code No.	D	C	ℓ	G No. (Option)	Collet
OK25-SK10	5~10	27.5	23	SKG10-10HG	SK10
-SK16	10~16	40	65	SKG16-12HG	SK16
OK32-SK10	5~10	27.5	23	SKG10-10HG	SK10
-SK16	10~16	40	65	SKG16-12HG	SK16
OK40-SK10	5~10	27.5	25	SKG10-10HG	SK10
-SK16	10~16	40	51	SKG16-12HG	SK16

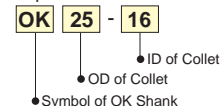
★Adjust Screw (G No.) is available as an option. P.44
 ★Please refer P.44 for Adjust Screw (G No.) .
 ★Please refer P.39 for Slim collet.

OK Shank Straight Collet for MOL and SLO (for drill)

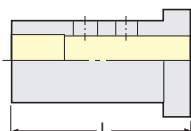


Code No.	L	L ₁
OK25-16, 20	56	45
OK32-16, 20, 25	61	45, 45, 55
OK40-32	71	60

Explanation of the Code No.

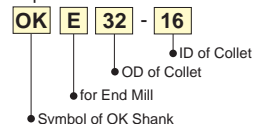


OK Shank Straight Collet for MOL and SLO (for end mill)



Code No.	L
OKE32-16, 20, 25	63
OKE40-20, 25, 32	73

Explanation of the Code No.



HIGH SPEED SPINDLE SPEEDER

NIKKEN



10,000~40,000min⁻¹

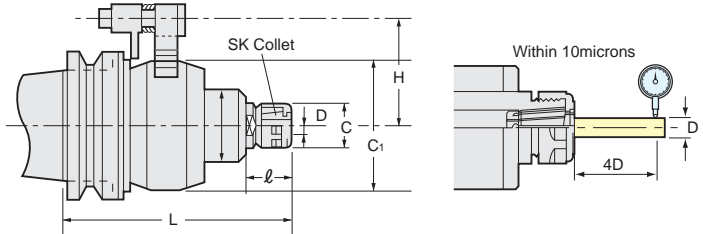
■ NIKKEN NX increases the spindle speed by 4 or 5 times, so economically convert your standard M/C to high speed M/C.

■ Inside gears are mirror-finish ground by NIKKEN original Fluid-Dynamic Grinding Process.

■ Run-out accuracy is more stable due to TiN Bearing Nut (standard accessory).

NX

Explanation of the Code No.
BT40-NX 5 160
 • Length
 • Ratio
 • NX : 4times, 5 times
 • PX : 6times, 10 times
 • Shank



TAPER	Code No.	D	L	C	C ₁	l	H	Ratio	MAX. min ⁻¹	Weight (kg)	Collet	
No.30	BT30-NX 5-153	1.75~10	153	27.5	85	32	55	5	20,000	2.9	SK10A	
	BT40-NX 5-153		153									
No.40	(IT40)-PX 6-150GX	0.5~8.0	149	22	76	14.5	60	6	30,000	4.1	ETS14	
	-PX10-160GX		162.5									
No.50	BT50-NX 4-192	1.75~16	192	40	118	46	82	4	10,000	11.0	SK16A	
	(IT50)-NX 5-151	1.75~10	151	27.5	85			5	20,000	7.0	SK10A	
	-PX 6-140GX	0.5~8.0	142	22	76			14.5	6	30,000	6.8	ETS14
	-PX10-155GX		155.5						98	10	40,000	

NX type

- ★ For End Mill, please use SK A type collet. For Drill, please use SK-P class collet. (P.39)
- ★ Wrench, Collet Extractor and A type SK Collets are supplied as standard.
- NX5: SK10-6A, 8A, 10A NX4: SK16-8A, 10A, 12A, 16A
- ★ Stopper block is available as an option. When ordering, please inform your M/C maker and Model as well as your M/C spindle flange dimension.
- ★ Air Cylinder for Cooling (NXE-COOL) is highly recommended to use for the stable milling.



Air Cylinder for Cooling with ON/OFF Magnet NXE-COOL

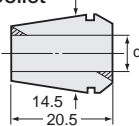
The best cooling is to cool the speeder body directly.



PX type

- ★ Grease lubrication is standard.
- ★ Please add "MX" instead of "GX" at the end of Code No. for the oil mist lubrication. e.g. BT40-PX6-130MX
- ★ ETS collet is supplied as an option.

ETS Collet



Explanation of the Code No.

ETS 14 - 0.5
 • MAX. Chucking Dia.
 • Style No.
 • Symbol of ETS Collet

- ★ d=0.5~1.0: Each 0.1mm (Gripping range : 0.1mm) e.g. ETS14-0.5 : 0.4~0.5mm
- ★ d=1.25~2.5: Each 0.25mm (Gripping range : 0.25mm)
- ★ d=3.0~8.0: Each 0.5mm (Gripping range : 0.5mm)

AIR TURBINE SPINDLE TOOL

NIKKEN

HTS

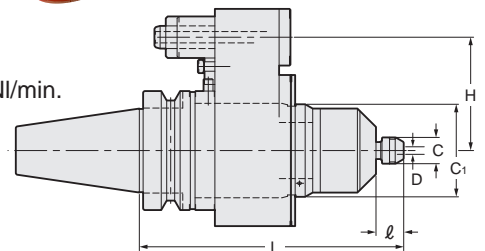


150,000min⁻¹

Run-out Accuracy of the Spindle: Within 1µm

Air Pressure, Consumption: 0.5MPa, 90NI/min.
 Collet Size : MAX 4.0mm

NEW



Please do not rotate the machine spindle.

Explanation of the Code No.

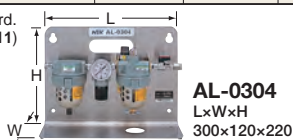
BT40-HTS1500-140
 • Nominal Gauge Length
 • 150,000min⁻¹
 • Symbol of Air Turbine Spindle
 • Shank No.

HSK shank is also available.

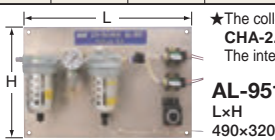
HSK 50A-HTS1500-158
HSK 63A-HTS1500-160
HSK100A-HTS1500-167

TAPER	Code No.	D	L	C	C ₁	l	H	Fixed min ⁻¹	Weight (kg)	Collet
No.30	BT30-HTS1500-148	0.5~4	148	13.9	49	15	55	150,000	2.7	CHA-□ (Internal dia.)
	-HTS1500-152B		152							
No.40	BT40-HTS1500-140		140							
	(IT40)-HTS1500-140		140							
No.50	BT50-HTS1500-146	146				82		6.0		

- ★ Collet CHA-4.0 and spanner are supplied as standard.
- ★ Air line kit (AL-0304/AL-951), the lubrication oil (K-211) and the stopper block are available as an option.



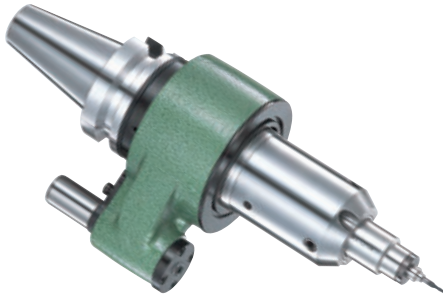
AL-0304
 LxWxH
 300x120x220



★ The collet which internal dia. excepts 4.0mm is available as an option.
CHA-2.35, 3.0, 3.175
 The internal dia. range is each 0.1mm incremental from 0.5 to 4.0mm.
AL-951 (DC24V ON/OFF)
 LxH
 490x320

AIR MOTOR SPINDLE TOOL NEW

NIKKEN



NBT-NR Photo shows **NR601**.

NR2351:30,000min⁻¹

Air Pressure, Consumption : 0.5MPa, 226ℓ/min
Collet Size : MAX φ6.0mm

Tools for NR2351

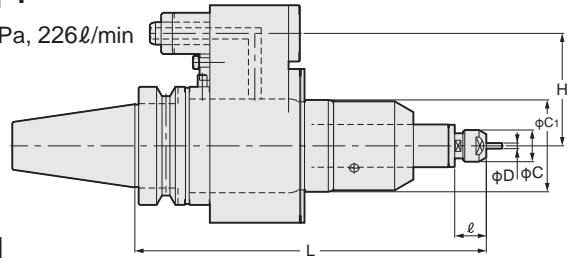
- Square End Mill : MAX.φ3.0mm
- Ball End Mill : MAX.R0.5mm
- Grinding Wheel : MAX.φ20mm

NR601:58,000min⁻¹

Air Pressure, Consumption : 0.6MPa, 160ℓ/min
Collet Size : MAX φ3.0mm

Tools for NR601

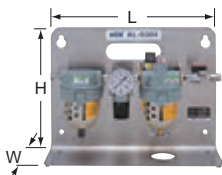
- Square End Mill : MAX.φ1.0mm
- Ball End Mill : MAX.R0.5mm
- Grinding Wheel : MAX.φ10mm



Please do not rotate the machine spindle.

TAPER	Code No.	D	L	C	C ₁	ℓ	H	Fixed min ⁻¹	Weight (kg)	Collet
No.30	NBT30-NR2351-208	0.5~6.35	208	16.9	49	16.9	55	30,000	3	CHK-□
	-NR2351-208B						40			
	-NR601 -210	8	55	58,000		CHM-□				
	-NR601 -210B		40							
No.40	NBT40-NR2351-188	0.5~6.35	188	16.9	16.9	60	30,000	3.7	CHK-□	
	(IT40)-NR601 -190	0.3~3.175	190	8.2	8	58,000	CHM-□			
No.50	NBT50-NR2351-208	0.5~6.35	208	16.9	16.9	82	30,000	6.7	CHK-□	
	(IT50)-NR601 -210	0.3~3.175	210	8.2	8	58,000	CHM-□			

Air Line Kit AL-0304 / AL-951



AL-0304 (Manual ON/OFF)
L×W×H 300×120×220



AL-951 (DC24V ON/OFF)
L×H 490×320

- The pressure can be adjusted.
- It can be mount on the wall.
- Lubrication oil is supplied as standard.
- Tool life can be extended.
- Eliminate the impurities from the air.

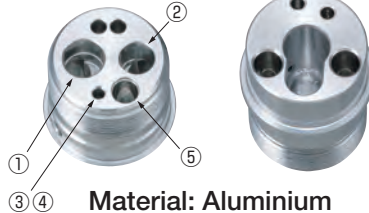
Preparation for automatic tool change

1. Compressor 0.5~0.6MPa
2. Installation of the air circuit including the air line kit (AL-951) and the stopper block
3. Modal M signals to activate the solenoid valve ON/OFF
4. Warning alarm or machine stop at the shortage of the oil. Further discussion is required.



The filter at the air line kit is not sufficient for the high humidity. Please install the air dryer near the filter at the air line kid.

NR2351 (30,000min⁻¹) Work Sample



Material: Aluminium

No.	Shape	Cutting condition	Time
①	φ3, 2t End mill	S30,000min ⁻¹ F150mm/min	5sec.
②	Drill hole: 11.5mm deep	11.5mm Deep	
③	φ1 Drill: 15mm deep	S30,000min ⁻¹ F120mm/min 15mm Deep	8sec.
④	φ1.32 Drill: 6mm deep	S30,000min ⁻¹ F250mm/min 6mm Deep	2sec.
⑤	φ1.32 Drill: 15mm deep	S30,000min ⁻¹ F120mm/min 15mm Deep	8sec.

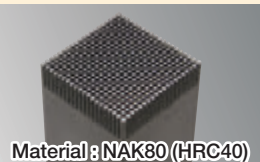
HTS1500 (150,000min⁻¹) Work Sample



Material NAK80 (HRC40)

No.	Shape	Cutting Condition	Cutting Length	Time
①	Pillamid (1.5mm deep)	Rough Ad 0.04 X Rd 0.04 F 3,000	82m	59min.46sec.
		Finish Ad 0.01 X Rd 0.01 F 2,000		
②	Pocket (1.0mm deep)	Rough Ad 0.04 X Rd 0.04 F 3,000	50m	1hour5min.22sec.
		Finish Ad 0.01 X Rd 0.01 F 2,000		
③	Pocket (2.0mm deep)	Rough Ad 0.04 X Rd 0.04 F 3,000	47m	1hour3min.17sec.
		Finish Ad 0.01 X Rd 0.01 F 2,000		

End Mill : Nissin MRB230 (R0.25×6)
S : 150,000min⁻¹
F : 2,500mm/min
Z : 0.01mm incremental
The groove of R0.25 × 5mm is machined in 19 lines and 19 lows at the □20mm × 20mm.



Material : NAK80 (HRC40)



The die mould profiling by the φ0.2mm end mill at the 150,000min⁻¹ can be done continuously and stably.

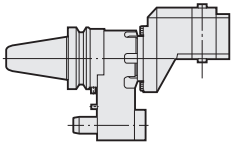
ANGULAR HEAD SYSTEM (Free Positioning in 360°)



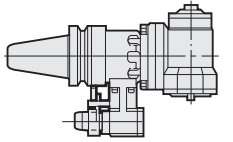
BT

Quick type Angular Head P.115

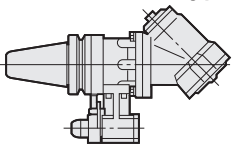
BT-AFT Off-Set type



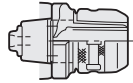
BT-AHT 90°type



BT-AHT 45°type



AHK-C



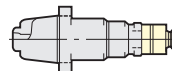
AHK-SK



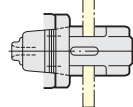
AHK-PC



AHK-Z



AHK-SCA



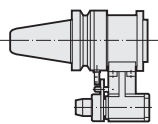
P.116

Various machining such as end milling, drilling, face milling, tapping etc. can be conveniently done by just changing adapter. Very suitable for production of many kinds of small quantity.

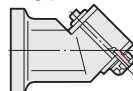
BT50-AFT35-90 Cutting Data Material of Work: S55C Carbon Steel				
Adaptor	Tool	Cutting WidthxDepth	min ⁻¹	Feed (mm/min)
SK10	HSS 2 Flutes End Mill	10x5.0	800	80
PC60	φ60 Face Mill	45x3.0	600	300
SCA	φ100x4 Side Cutter	4.0x6.0	70	70
C20	φ18.5 Drill	18.5x40	400	80

Modular type Angular Head P.117

BT-AHM Modular type Main Body

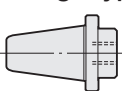


AHM-SK 45°type

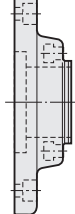


Direct Mount Flange type Angular Head P.119

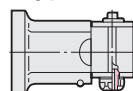
NT-F Direct Mount Flange type Shank



F Flange



AHM-SK 90°type

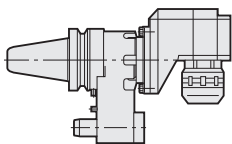


Head can be changed according to the application. Small Dia. Head, 45° or 90° Head, Long Head etc. are available in standard series. For Heavy Cutting, Direct Mount Flange type is recommended.

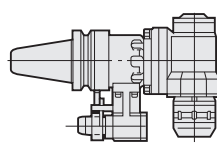


Solid Type Angular Head P.118

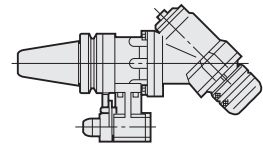
AFK AFC Off-Set type



AHK AHC 90°type



AHK AHC 30°,45°,60°types



- Free Radius Positioning in 360°.
- Taper Connection System is applied to Stopper Block. (Different from the one of another FA tooling)
- Oil Hole type is available. Please contact with us.
- Special Degree Angular Head is available on demand.
- Spindle Speeder type Angular Head (X5 times, MAX. 18,000min⁻¹) is available.

BT40-AHPX10-215, BT50-AHPX10-206
IT40-AHPX10-215, IT50-AHPX10-206

Spindle Speeder type Angular Head
MAX.18,000min⁻¹



Angular Head with Oil Hole System

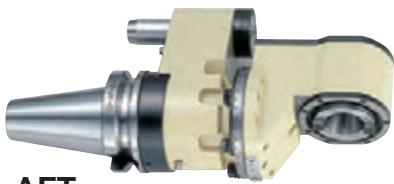


Most popular Slim Chuck SK10, 16, 25 and Milling Chuck C20, 32 are combined as solid. High Precision and High Rigidity are ensured.

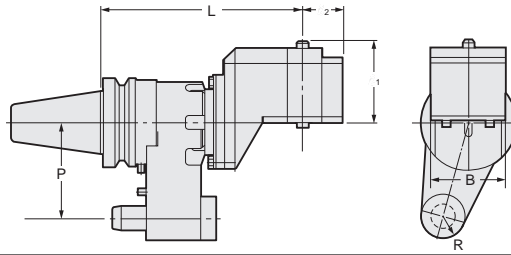
QUICK TYPE ANGULAR HEAD (Free Positioning in 360°)



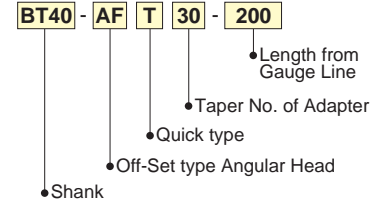
Quick type Off-Set Angular Head



AFT



Explanation of the Code No.

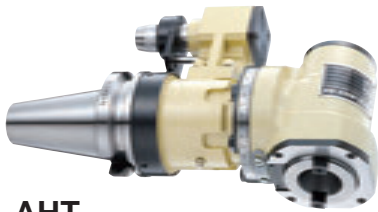


MAX 2,000 min⁻¹

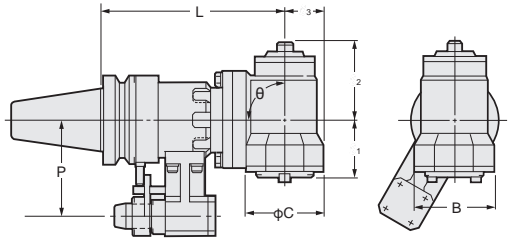
TAPER	Code No.	Shank	L	P	l ₁	l ₂	B	R	Adapter	Weight (kg)
No.40	BT40 (IT40)-AFT30-200	BT40	200	65	85	35	70	17.5	AHK30	7.5
No.50	BT50 (IT50)-AFT35-230	BT50	230	110	85	45	84	25	AHK35	16.0

★Taper Connection System is applied to Stopper Block. (Different from the another FA Tooling) ★All types are available with Oil Hole System.
 ★Stopper block is available as an option. When ordering, please inform your M/C maker and Model as well as your M/C spindle flange dimension.
 ★IT40-AFT30-200 and IT50-AFT35-230 are also available. ★When M/C spindle rotates CW, the cutter rotates CW.

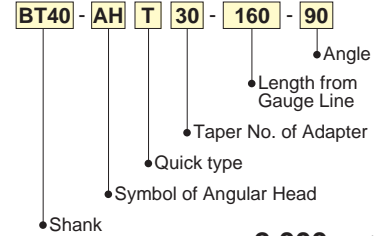
Quick type 90° Angular Head



AHT



Explanation of the Code No.

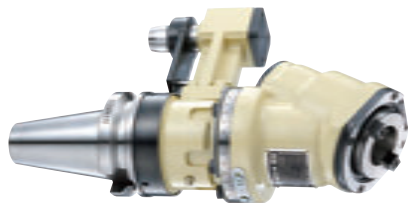


MAX 2,000 min⁻¹

TAPER	Code No. L -θ	Shank	L	P	l ₁	l ₂	l ₃	C	B	θ	Adapter	Weight (kg)
No.40	BT40-AHT30-160 -90	BT40	160	65	58	61	37	86	80	90	AHK30	6.5
	(IT40) -250* -90	BT40	250									10.5
No.50	BT50-AHT35-210 -90	BT50	210	110	65	88	45	100	90	90	AHK35	17.0
	(IT50) -300* -90	BT50	300									22.0

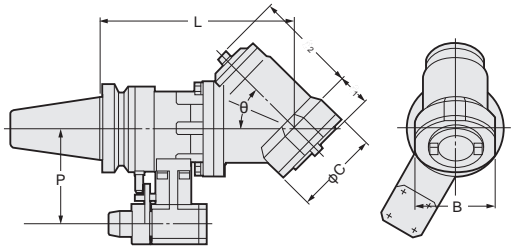
★Taper Connection System is applied to Stopper Block. (Different from the another FA tooling) ★All types are available with Oil Hole System.
 ★Stopper block is available as an option. When ordering, please inform your M/C maker and Model as well as your M/C spindle flange dimension.
 ★Models with * mark : Detailed discussion is needed. ★When M/C spindle rotates CCW, the cutter rotates CW.

Quick type 30°, 45°, 60° Angular Head

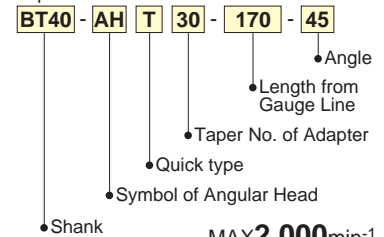


AHT

Photo shows 30° type.



Explanation of the Code No.



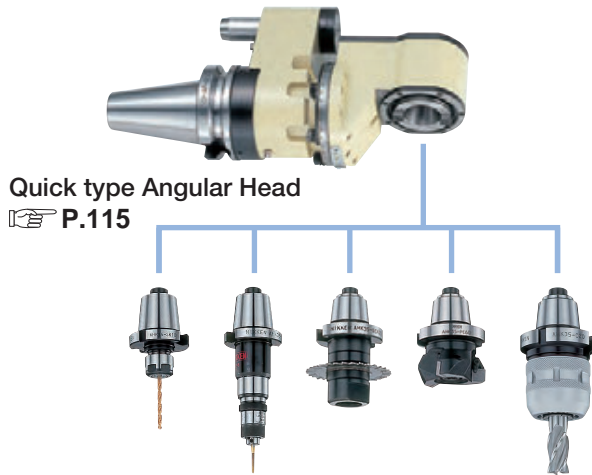
MAX 2,000 min⁻¹

TAPER	Code No. L -θ	Shank	L	P	l ₁	l ₂	C	B	θ	Adapter	Weight (kg)
No.40	BT40-AHT30-205 -30	BT40	205	65	1.5	122	86	80	30	AHK30	6.5
	(IT40) -170 -45		170		35	88			45		6.5
	-160 -60		160		35	88			60		6.5
	-250* -30	BT40	250	65	1.5	122	86	80	30	AHK30	10.5
	-45		35	88	45	10.5					
	-60		35	88	60	10.5					
No.50	BT50-AHT35-258 -30	BT50	258	110	0	140	100	90	30	AHK35	17.0
	(IT50) -225 -45		225		26	110			45		17.0
	-210 -60		210		40	105			60		17.0
	-300* -30	BT50	300	110	0	140	100	90	30	AHK35	22.0
	-45		26	110	45	22.0					
	-60		40	105	60	22.0					

★Taper Connection System is applied to Stopper Block. (Different from the another FA tooling) ★All types are available with Oil Hole System.
 ★Stopper block is available as an option. When ordering, please inform your M/C maker and Model as well as your M/C spindle flange dimension.
 ★Models with * mark : Detailed discussion is needed. ★When M/C spindle rotates CCW, the cutter rotates CW.

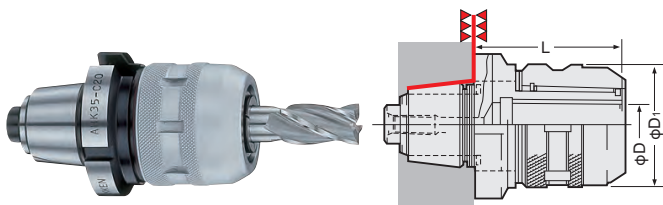
ADAPTER FOR QUICK TYPE ANGULAR HEAD

NIKKEN



Quick type Angular Head
☞ P.115

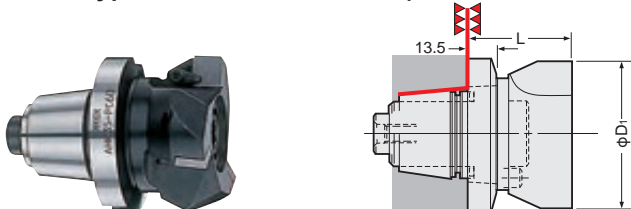
Quick type Milling Chuck (Double Face Contact)



Code No.	D	L	D ₁	Weight(kg)	KM Collet
AHK30-C16		60	44	1.0	KM16
AHK35-C16,C20		60, 65	44, 52	1.1, 1.2	KM16 KM20

★For KM COLLET, please refer ☞ P.31.

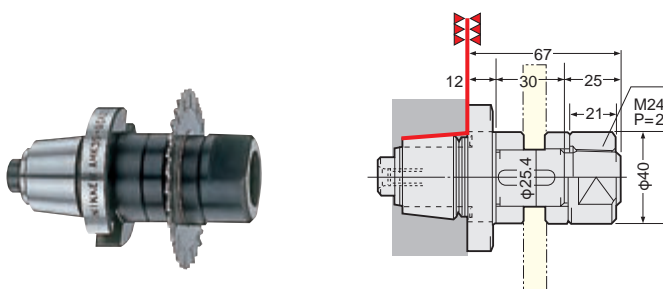
Quick type NIKKEN PRO-CUT (Double Face Contact)



Code No.	PC.No.	L	D ₁	Weight(kg)
AHK30-PC50		45	50	0.7
AHK35-PC60,PC80		45, 57	60, 80	0.9, 1.3

★Inserts are standard accessory.

Quick type Side Cutter Arbor (Double Face Contact)



Code No.	L	D	D ₁	Weight(kg)
AHK35-SCA25.4	12	25.4	40	1.1

★The key and set of distance collars are standard accessory.

Quick type Slim Chuck



Code No.	SK.No.	D	L	D ₁	Weight(kg)	SK Collet
AHK30-SK10		1.75~10	35	27.5	0.4	SK10
-SK16		2.75~16	50	40	0.6	SK16
AHK35-SK10		1.75~10	35	27.5	0.5	SK10
-SK16		2.75~16	50	40	0.7	SK16

★SK Collet is not included, please refer ☞ P.39.

Quick type Tapper Chuck

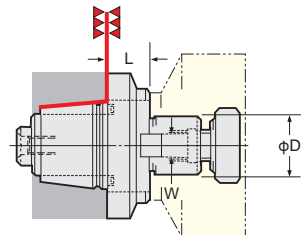


Code No.	Z.No.	L	Weight(kg)	Tap Collet
AHK30-Z8, Z12		85, 100	0.6, 0.9	ZKN 8 ZKG12
AHK35-Z8, Z12, Z16		75, 85, 100	0.7, 1.0, 1.5	ZKN 8 ZKG12 ZKG16

★Tapping Capability Z8 : M2~8 Z12 : M2~12 Z16 : M3~20

★Tap Collet is not included, please refer ☞ P.53.

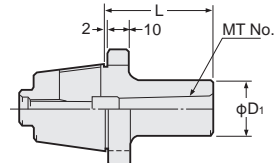
Quick type Face Mill Arbor (Double Face Contact)



Code No.	L	D ₁	W	Weight(kg)
AHK35-FMA25.4	18.5	25.4	9.5	0.7
-FMA31.75		31.75	12.7	0.8

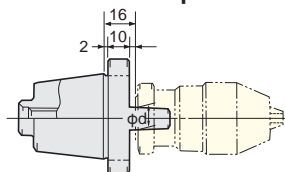
★The Keys and a Bolt are standard accessory.

Quick type Morse Taper Sleeve



Code No.	MT.No.	L	D ₁	Weight(kg)
AHK30-MT1, MT2		50, 65	25, 32	0.4, 0.5
AHK35-MT1, MT2, MT3		50, 60, 85	25, 32, 40	0.5, 0.6, 0.9

Quick type Drill Chuck Adapter



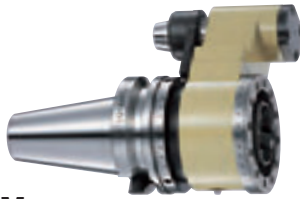
Code No.	J.No.	L	J.No.	Weight(kg)
AHK30-J6	J6	16		0.4
AHK35-J6				0.5

★This adapter is supplied without drill chuck.

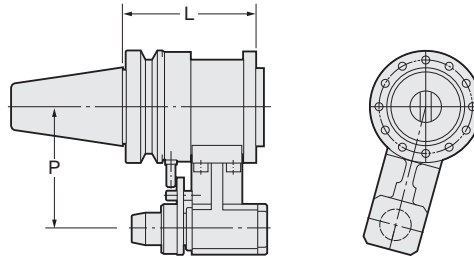
MODULAR TYPE ANGULAR HEAD

NIKKEN

Modular type Angular Head AHM



AHM



MAX 6,000 min⁻¹

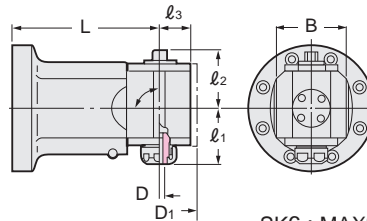
TAPER	Code No. -L	L	P	Weight (kg)	Suitable Modular Head
No.40	BT40 (IT40)-AHM-100	100	65	4.5	
No.50	BT50 (IT50)-AHM-120	120	110	11.5	

★Taper Connection System is applied to Stopper Block. (Different from the another FA Tooling) ★All types are available with Oil Hole System.
★Stopper block is available as an option. When ordering, please inform your M/C maker and Model as well as your M/C spindle flange dimension.

90°type Modular Head AHM90



AHM



Explanation of the Code No.

AHM90 - **SK6** - **80**

- Length from Gauge Line
- Symbol of Slim Chuck
- Symbol of Modular Head 90°type

SK6 : MAX 6,000 min⁻¹ SK10,16 : MAX 4,000 min⁻¹

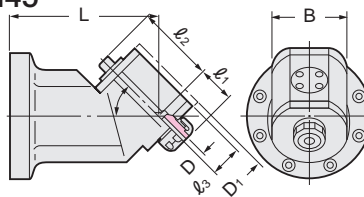
Code No. -L	D	l ₁	l ₂	l ₃	D ₁	B	Weight (kg)	SK Collet
AHM90-SK 6-80, 120, 150*	0.7~6	42	35	22	50	48	3.0, 4.0, 4.5	SK 6
-SK10-80, 120, 150*	1.75~10	63	57	32	64	60	3.5, 4.5, 5.0	SK 10
-SK16-80, 120, 150*	2.75~16	66	58	35	74	70	4.2, 5.2, 5.7	SK 16

★★Mark is for light machining. ★For SK Collet, please refer P.39. ★When M/C spindle rotates CCW, the cutter rotates CW.

30°, 45°, 60°type Modular Head AHM45



AHM



Explanation of the Code No.

AHM45 - **SK6** - **120**

- Length from Gauge Line
- Symbol of Slim Chuck
- Symbol of Modular Head 45°type

SK6 : MAX 6,000 min⁻¹ SK10,16 : MAX 4,000 min⁻¹

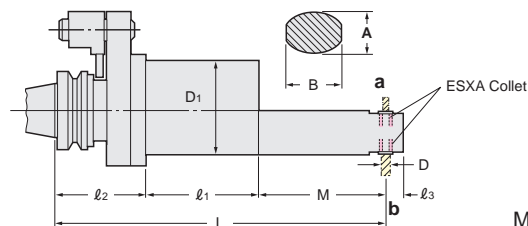
Code No. -L	D	l ₁	l ₂	l ₃	D ₁	B	Weight (kg)	SK Collet
AHM45-SK 6-120, 150*	0.7~6	27	67	22	50	52	3.0, 4.0, 4.5	SK 6
-SK10-120, 150*	1.75~10	39	80	30	64	60	3.5, 4.5, 5.0	SK 10
-SK16-120, 150*	2.75~16	38	90	35	74	70	4.2, 5.2, 5.7	SK 16

★★Mark is for light machining. ★For SK Collet, please refer P.39. ★Angle 30°, 60° are also available as an option. ★When M/C spindle rotates CCW, the cutter rotates CW.

Angular head for deep hole AHPL



AHPL



MAX 3,500 min⁻¹

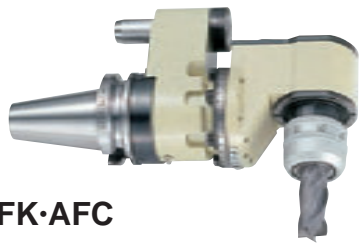
TAPER	Code No. -L	D	D ₁	A	B	L	M	l ₁	l ₂	l ₃	min ⁻¹	Weight (kg)	Applicable Collet
No.40	BT40-AHPL4-199	1.0~4.0	80	25	31	199	32	67.5	99.5	14.5	6,450	5.0	ESXA4
	-223					56	5.5						
	-247					80	6.0						
	-271					104	7.5						
	-AHPL6-208					207.5	46.5					5.0	
No.50	-236	1.0~6.0	80	36	45	235.5	74.5	61.5	99.5	15	8,000	6.0	ESXA6
	-264					263.5	102.5					8.0	
	BT50-AHPL6-221					220.5	46.5					7.0	
	-249					248.5	74.5					8.0	
	-277					276.5	102.5					10.0	
	-AHPL8-248					247.5	73					9.0	
						279.5	105					10.0	
299.5		125	11.0										

★ESXA Collet is supplied as an option. ★Different shape is possible, please contact with us for more detail.
★When M/C spindle rotates cw, the cutter at a rotates CW and the cutter at b rotates CCW. ★IT40-AHPL6-270 and IT50-AHPL8-288 are also available.

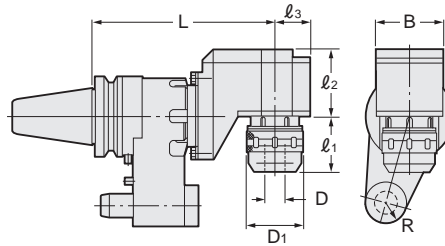
SOLID TYPE ANGULAR HEAD (Free Positioning in 360°)



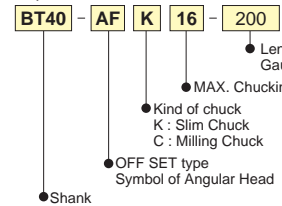
Solid OFF SET type Angular head



AFK·AFC



Explanation of the Code No.



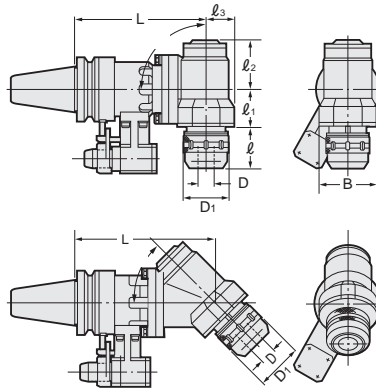
TAPER	Code No. -L	D	D ₁	l ₁	l ₂	l ₃	B	R	min ⁻¹	Weight (kg)	Collet
No.40	BT40-AFK16-200	2.75~16	40	50	85	35	70	17.5	2,000	8.5	SK 16
	(IT40)-AFC20-200	2~20	52	56						8.7	KM 20
No.50	BT50-AFC20-230	2~20	52	58	85	45	84	25	2,000	17.0	KM 20
	(IT50)-AFC32-230	3~32	69	65						17.2	KM 32

★Taper Connection System is applied to Stopper Block. (Different from the another FA Tooling) ★All types are available with Oil Hole System.
 ★Stopper block is available as an option. When ordering, please inform your M/C maker and Model as well as your M/C spindle flange dimension.
 ★For (SK16), please refer P.39. For (KM20) and (KM32), please refer P.31.
 ★Please advise name of M/C builder and model No. etc. ★When M/C spindle rotates CW, the cutter rotates CW.

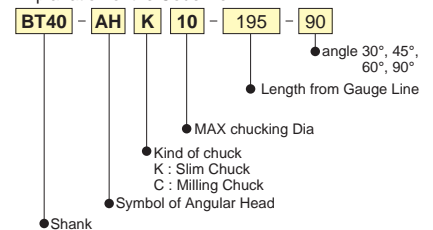
Solid - 90°, 45° type Angular head



AHK·AHC



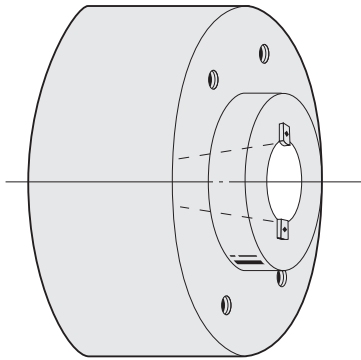
Explanation of the Code No.



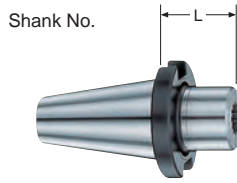
TAPER	Code No. -L	-	D	D ₁	l	l ₁	l ₂	l ₃	B	min ⁻¹	Weight (kg)	Collet
No.30	BT30-AHK10-120-90		1.75~10	27.5	20	49	50	27.5	55	2,000	3.0	SK 10
No.40	BT40-AHK10-180,220*90		1.75~10	27.5	18	45	57	32	60	4,000	8.0, 9.0	SK 10
	(IT40)-AHK16-180,220*90		2.75~16	40	25	41	58	35	70		8.7, 9.7	SK 16
		-AHC20-160,250*90		2~20	52	57	58	61	37	80	2,000	7.1, 11.1
No.50	BT50-AHK10-200,240*90		1.75~10	27.5	18	45	57	32	60	4,000	15.0, 16.0	SK 10
	(IT50)-AHK16-200,240*90		2.75~16	40	25	41	58	35	70		15.7, 16.7	SK 16
		-AHK25-210,300*90		7.5~25.4	55	57	60	82	45	90	17.2, 22.2	SK 25
		-AHC32-210,300*90		3~32	69						17.5, 22.5	KM32

★Taper Connection System is applied to Stopper Block. (Different from the another FA Tooling) ★All types are available with Oil Hole System.
 ★Stopper block is available as an option. When ordering, please inform your M/C maker and Model as well as your M/C spindle flange dimension.
 ★For (SK10) (SK16) (SK25), please refer P.39. For (KM20) (KM25) and (KM32), please refer P.31.
 ★Angle 30°, 45°, 60° are also available as an option. ★* Mark is for light cutting.
 ★When M/C spindle rotates CCW, the cutter rotates CW.
 ★Please contact with us for the dimension of 30°, 45°, 60° type.

DIRECT MOUNT FLANGE TYPE ANGULAR HEAD



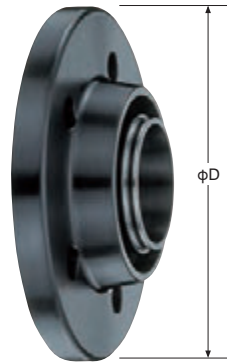
Spindle



Direct Mount Flange type Shank

Code. No.
NT 50 - F 235 - 14

Shank No. φD



Flange

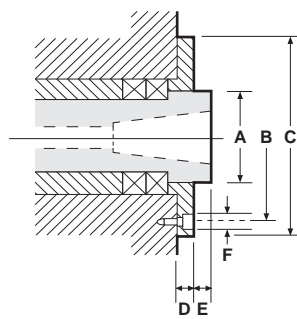
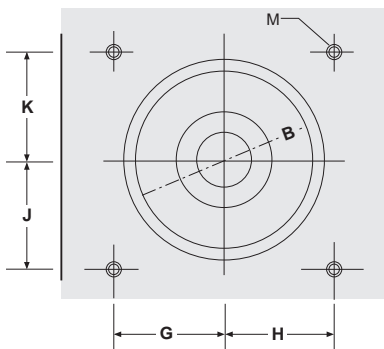
Code. No.
F 235 - AHM

φD Symbol of Flange type Symbol of Modular type Angular Head



Modular Head

P.117



We have a lot of experience of Special Angular Heads such as Flange Mount type, Both Sides Spindles type Heads and Angular Head for High Speed Rotation. Please contact with us.

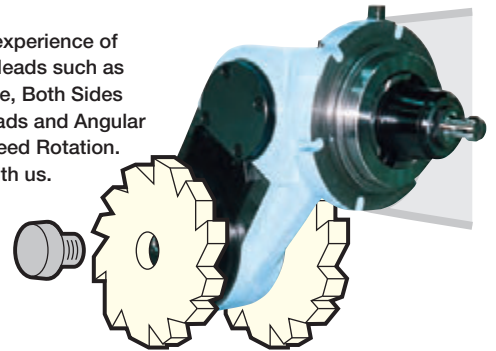


Photo shows NC5 Shank.

★When ordering, please let us know above A, B, C, D, E, F, G, H, J, K, M and Work Drawing.

MULTI SPINDLE HEAD SERIES



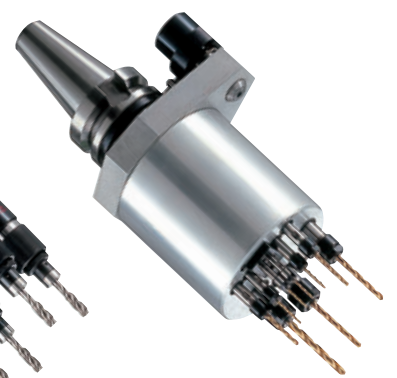
MHS ① Multi Drill Head (for Straight Shank Drill)



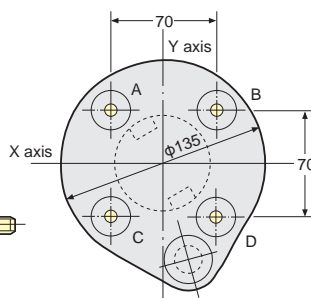
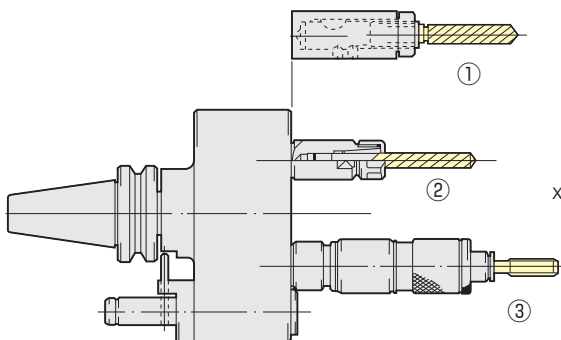
MHD ② Multi Drill Head (for MT Shank Drill)



MHT ③ Multi Drill Head (for Tapper Chuck)



MHV High Speed Multi Drill Head MAX.8,000min⁻¹



Please specify the below when ordering.

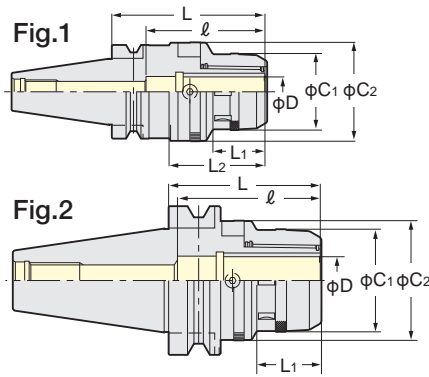
- M/C Maker, Model No. Drawing of Spindle Flange. Stopper Block is provided or not.
- Coordinates of each hole A(X= -35, Y= 35) B(X= 35, Y= 35) C(X= -35, Y=-35) D(X= 35, Y=-35) or pitch and number of holes.
- A diameter of drill or tap
- Material

ZERO FIT TYPE MILLING CHUCK NEW

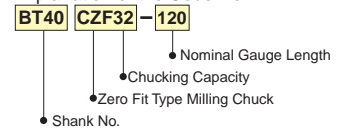
NIKKEN



CZF



Explanation of the Code No.



MAX. run-out at 100mm	
CZF20	0.050mm / dia.
CZF25	0.050mm / dia.
CZF32	0.030mm / dia.

PAT.

TAPER	Code No.	C1	C2	L	L1	L2	l	Weight (Kg)	Fig.	Collet
No.30	BT30-CZF20-100	51.5	66.5	100	35	68	80	1.5	1	KM20 CCK20
	-CZF25-100	59.5	74.5					1.6		KM25 CCK25
No.40	BT40-CZF20-105, 120	51.5	66.5	105, 120	35	64.5	80	2.1, 2.5	1	KM20 CCK20
	-CZF25-105, 120	59.5	74.5			68		2.4, 2.9		KM25 CCK25
	-CZF32-120	69	80.5	120	42	78	105	2.8		KM32 CCK32
No.50	BT50-CZF20-105, 165	51.5	66.5	105, 165	35	-	80	4.6, 6.0	2	KM20 CCK20
	-CZF25-105, 165	59.5	74.5					5.0, 6.8		KM25 CCK25
	-CZF32-105, 165	69	80.5	105	42	105	5.3, 7.4	KM32 CCK32		

★Spanner is available as an option.

CZF20 type : 9HC22, CZF25 type : 9HC25, CZF32 type : 9HC32

★Wrench to adjust run-out (9ZFL) is available as an option.



Wrench to adjust
9ZFL

★Please refer P.31, P.32 for KM, CCK collet.

★When direct chucking of centre through tool coolant, please use CKFN-D nut.

When using collet, please use CCK collet and CKFN nut. P.32

★Please note the acceptable shank tolerance is h7.

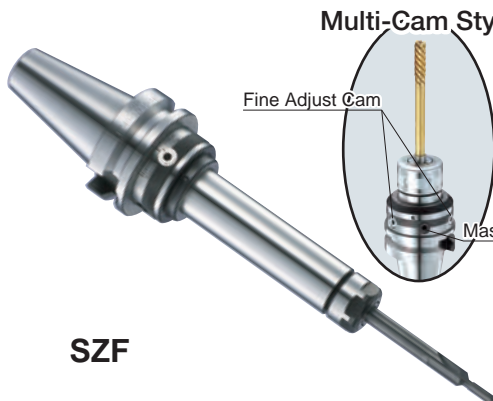
★For How to Adjust the Run-Out, please refer P.156.



- In case of CZF (Milling Chuck) style, please rotate the Adjust Cam to the free position. Then, tighten the nose ring until face contact.
- If the face contact is not completed, the Adjust Cam can not function. (Free run)
- If the Adjust Cam is not at the free position before tightening, you can not tighten the nose ring until face contact correctly.
- For the safety reason, the Cam Ring Lock Screws can not be loosen to remove to the outside. Please loose the Cam Ring Lock Screws slightly to rotate the Cam Ring.

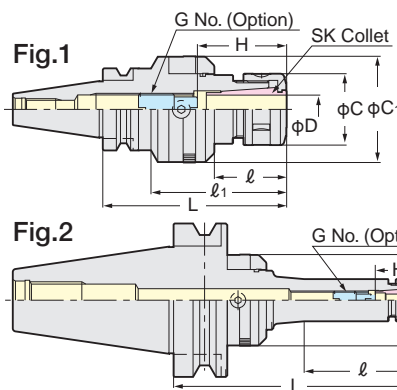
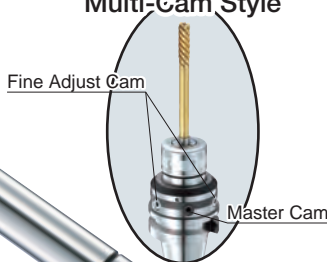
ZERO FIT TYPE SLIM CHUCK NEW

NIKKEN

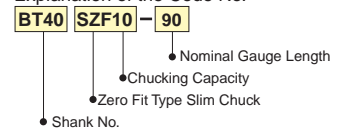


SZF

Multi-Cam Style



Explanation of the Code No.



MAX. run-out at 100mm		
SZF 6	L < 150	0.050mm / dia.
	L ≥ 150	0.040mm / dia.
SZF10		0.050mm / dia.
SZF16		0.040mm / dia.
SZF25		0.025mm / dia.

PAT.

TAPER	Code No.	D	L	l	l1	C	C1	H	G No. (Option)	Weight (Kg)	Fig.	Collet
No.30	BT30-SZF 6- 90	0.7~6.0	90	42	-	19.5	40.5	21~35	SKG- 8	0.9	2	SK 6
	-SZF10- 90	1.75~10.0		35	61	27.5	48.5	30~50	SKG-12L	1.3	1	SK10
	-SZF16-105	2.75~16.0		105	40	76	40	59.5	45~65	SKG-18L		1.6
No.40	BT40-SZF 6- 90,150	0.7~6.0	90, 150	37, 60	-	19.5	40.5, 48.5	21~35	SKG- 8	1.3, 1.7	2	SK 6
	-SZF10- 90,150	1.75~10.0		37, 97		27.5	48.5	30~50	SKG-12L	1.5, 1.9		SK10
	-SZF16- 90,150	2.75~16.0	40	59.5	40~70	SKG-18L	1.8, 2.2	SK16				
	-SZF25-120,150	7.5~25.4	120, 150	55, 86	84, 114	55	66.5	55~85	SKG-28	2.4, 2.9	1	SK25
No.50	BT50-SZF 6-105,165	0.7~6.0	105, 165	41, 63	-	19.5	40.5, 59.5	21~35	SKG- 8	4.0, 4.2	2	SK 6
	-SZF10-105,165	1.75~10.0		41, 101		27.5	48.5	30~50	SKG-12L	4.5, 4.9		SK10
	-SZF16-105,165	2.75~16.0	40	59.5	40~70	SKG-18L	5.0, 5.4	SK16				
	-SZF25-135,165	7.5~25.4	135, 165	71, 101	55	66.5	55~85	SKG-28	5.8, 6.0	1	SK25	

★Adjust screw (G No.), wrench to adjust run-out (9ZFL) and SKL spanner are available as an option. SZF6: SKL-6W, SZF10: SKL-10, SZF16: 9HC16, SZF25: 9HC25

★Please use "P" class or "A" type SK collet. P.39

★For centre through coolant application please use SK J type nut and cap for your preference. Please note that the length of J type nut is 6mm longer than the standard SK nut. P.43

★For High Speed type, Code No. is "GSZF-P". e.g. BT40-GSZF10-90P GH handle P.30 is necessary for High Speed Milling Chuck.

★For How to Adjust the Run-Out, please refer P.156.

★Multi-Cam style is available. e.g. BT40-SZF16-90-C3. (3 Cams) Please contact us for more detail.

AUTOMATIC BACK SPOT FACING ARBOR

NIKKEN

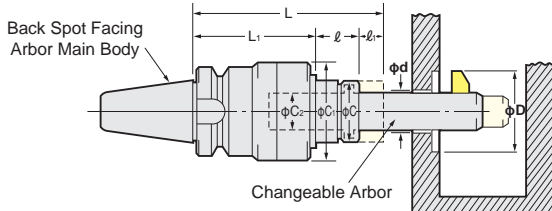
No Swarf Adhesion. Mechanical Automatic Blade In/Out System.
No Need of Stopper Block.



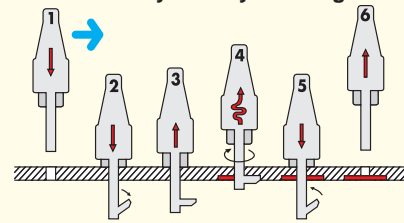
NEW

Coolant Through is standard.

AF-OH



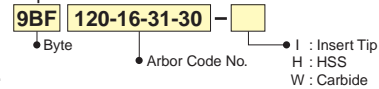
Operational Procedure of Back Spot Facing Arbor (Full Automatic System by NC Programming)



The front end arbor is changeable to suit different facing diameter. Byte can be selected as follows;

- HSS : Powdered HSS + Ion Nitrided + TiAlN Coated (Min. order : 3pcs)
- Carbide : Grade P, K or M can be selected. (Min. order : 5pcs)
- Insert Tip

Explanation of the Code No.



d MIN. and D MAX. are the figures only for the selection of the main body.

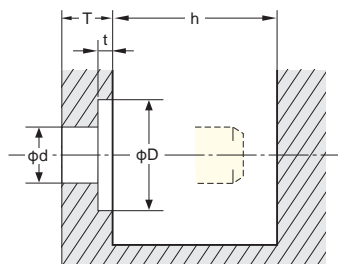
TAPER	Code No.	d	D	L	L1	l	l1	C	C1	C2	Weight (kg)	Arbor Code No.
		MIN.	MAX.									
No.40	BT40-AF1-20-OH	16	32	185	143	7	35	60	90	32	4.5	BF120-d-D-T
	(IT40) -30-OH	29	58	205	153		45				4.8	BF130-d-D-T
	-40-OH	40	80	225	163		55				5.0	BF140-d-D-T
No.50	BT50-AF1-20-OH	16	32	160	118	7	35	60	90	32	6.0	BF120-d-D-T
	(IT50) -30-OH	29	58	180	128		45				6.5	BF130-d-D-T
	-40-OH	40	80	200	138		55				7.0	BF140-d-D-T
	BT50-AF2-50-OH	50	90	230	158		65				9.0	BF250-d-D-T
	(IT50) -60-OH	60	100	250	168		75				9.5	BF260-d-D-T
	-70-OH	70	130	270	178		85				10.0	BF270-d-D-T
	-80-OH	80	160	290	188		95				10.5	BF280-d-D-T
	-90-OH	90	180	310	198		105				11.0	BF290-d-D-T

Changeable Arbor for Automatic Back Spot Facing Arbor ... The changeable arbor is made according to your order.



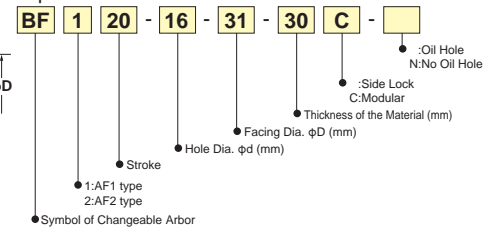
BF Option: TiN Coated

Please specify ϕd , ϕD , t , T , h and material, when ordering.



Material	Hole Dia. ϕd	Facing Dia. ϕD	Facing Depth t	Thickness T	Space h

Explanation of the Code No.



Grade : Coated Material : Steel, Cast Iron

Code No.	Dimension	A	B	T	ϕd	Nose R	Tip Clamp Bolt	Tip Clamp Handle
AFC- 9		9.5	6.4	2.4	2.8	0.4	M2560S	T 8
-15		15						
-20		20.5	7	3.2	3.5	0.8	M3070S	T10
-27		27.4						
-35		35	9.4	5.4	3.5			
-45	45			2 pcs		M3070S 2 pcs		

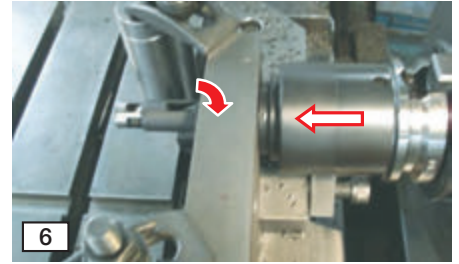
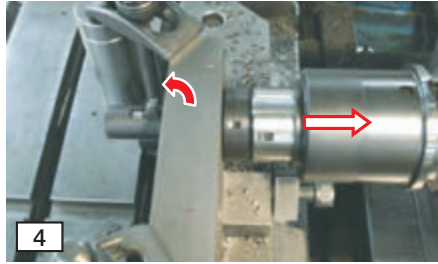
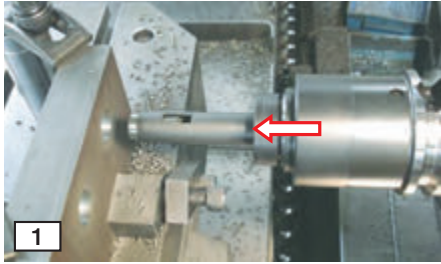
Application



SEQUENCE of BACK SPOT FACING

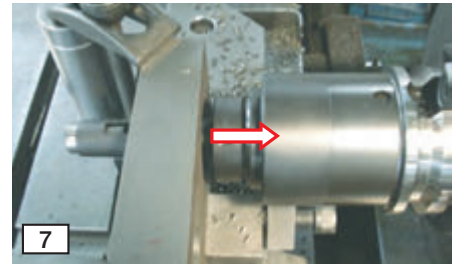
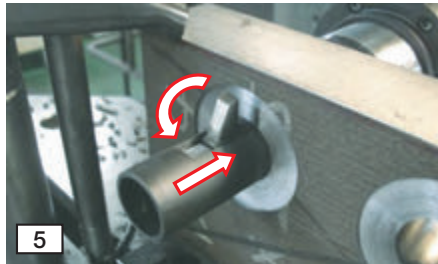
NIKKEN

Z75. and **Z-75.** are the position by the stroke of the cam inside, and the figure will be different per arbor Code No.



G91G01Z75. F4000;

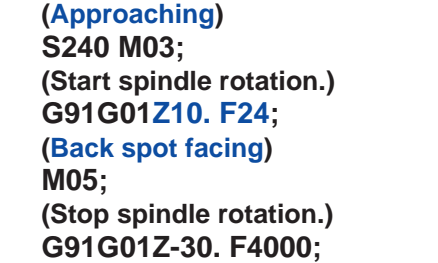
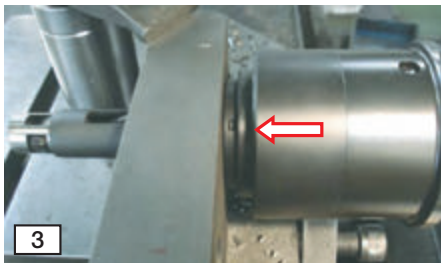
G01Z-75. F4000;



Face contact

G91G01Z20. F4000;

G91G01Z20. F4000;



G91G01Z-15. F4000;

(Move to the position of face contact.)

G91G01Z100. F4000;

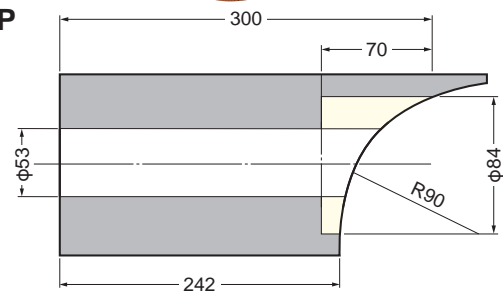
MANUAL BACK SPOT FACING ARBOR

NEW

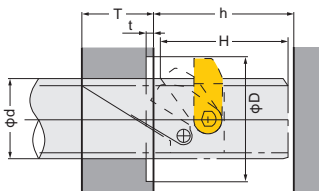
NIKKEN

e.g. ST32-MF53-84-300

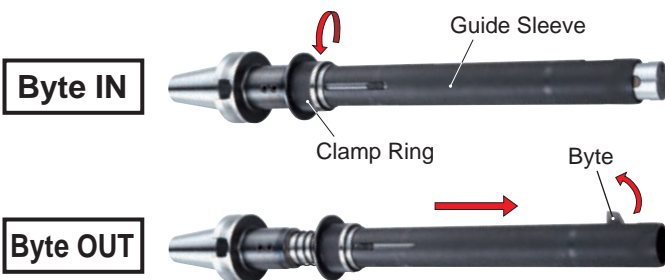
PAT.P



MF

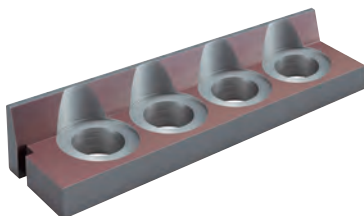


★Please specify ϕd , ϕD , t , T , h and material, when ordering. H (Dimension for byte in/out) is depended on ϕd and ϕD .



Operation

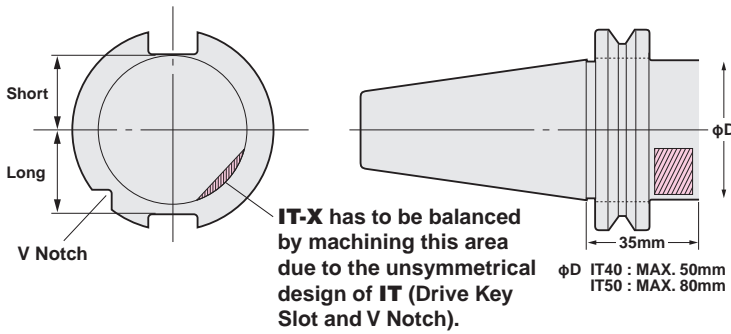
1. X, Y Positioning
2. Z down (Insert the arbor into the hole.)
3. Rotate clamp ring causes guide sleeve forward to push the byte out.
4. Z up (Back spot facing)
5. Z Down
6. Rotate clamping in reverse direction causes guide sleeve backward to store the byte in.
7. X, Y Moving



Sample

Material : FCD200 V=30m/min.
Hole : $\phi 53$ f=0.1mm/rev.
Facing Dia. : $\phi 84$

What is IT Shank Tooling?



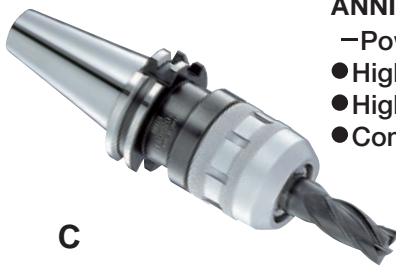
IT shank is based on ISO 7388/1-'83 (DIN69871-'90) and its flange has an unsymmetrical shape.

- Depth of Drive Key Slots are different.
- V Notch on one side.

Therefore, NIKKEN IT_X shank has a groove at bottom of V groove for mass balancing.

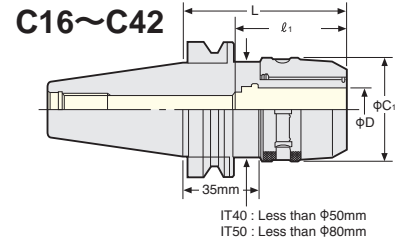
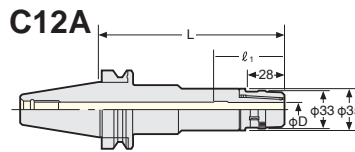
Diameter "D" below the flange is restricted under the above standard. Normally the holder for large diameter cutter has a large body, therefore, large diameter at "D" is expected. However, in case of IT Shank large diameter tool holder, "D" is smaller than the front end part due to the standard, and the length from gauge line is also different from BT Shank tool holders.

IT MULTI LOCK MILLING CHUCK



ANNIVERSARY Type

- Powerful gripping torque-
- High rigidity
- High precision
- Compact design



TAPER	Code No.	C ₁	L	ℓ_1	Collet	Weight (kg)
No.40	IT40-C12- 65, 90, 120* ¹	33	65, 90, 120	58	KM12 CCK12	1.3, 1.6, 1.8
	-C16- 60, 90, 120* ¹	44	60, 90, 120	65	KM16 CCK16	1.4, 1.7, 2.0
	-C20- 80, 90, 105, 120* ²	52	80, 90, 105, 120	80	KM20 CCK20 CCNK20	1.6, 1.8, 2.0, 2.2
	-C25- 85, 105, 120	60	85, 105, 120	80	KM25 CCK25 CCNK25	2.1, 2.3, 2.5
	-C32- 95, 105, 120	64	95, 105, 120	82, 95, 105	KM32 CCK32 CCNK32	2.1, 2.5, 2.8
No.50	IT50-C12-105, 135, 165* ¹	33	105, 135, 165	58	KM12 CCK12	4.0, 4.3, 4.6
	-C16-105, 135, 165* ¹	44	105, 135, 165	65	KM16 CCK16	4.2, 4.6, 5.1
	-C20-105, 135, 165, 180* ¹	52	105, 135, 165, 180	80	KM20 CCK20 CCNK20	4.5, 5.1, 5.7, 6.0
	-C25-105, 135, 165	60	105, 135, 165	80	KM25 CCK25 CCNK25	4.8, 5.2, 5.6
	-C32- 85, 105, 120, 135, 165	69	85, 105, 120, 135, 165	105	KM32 CCK32 CCNK32	4.1, 4.6, 5.1, 5.6, 6.4
	-C42- 95, 105, 135, 165* ¹	86	95, 105, 135, 165	125	KM42 CCK42 CCNK42	5.2, 5.5, 7.2, 8.6

- ★Spanner is available as an option.
- C12($\phi 30$):9HC12, C12A($\phi 33$):9HC12A, C16:9HC16, C20: 9HC20, C25: 9HC25, C32& $\phi C_1=64$:9HC25, C32:9HC32, C42:9HC42
- ★Please note the acceptable shank tolerance is h7.
- ★For KM, CCK and CCNK Collet, please refer to P.31, P.32.
- ★For heavy duty milling, please grip the end mill shank longer than ℓ_1 .
- ★For Milling Chucks marked *2, NK Collet, CCNK Collet, ONK Collet and OJK Collet can not be used.
- ★Milling chucks marked *1 are available as an option.
- ★IT50-C32-200, 250 and IT50-C42-200,250 are also available as an option.
- ★C22 style is also available.
- ★Please add "C" for the centre through tool coolant type.
- IT40-C20C-80, 90, 105, 120 IT50-C20C-105, 135, 165*¹
- C25C-85, 105 -C25C-105, 135, 165*¹
- C32C-95, 105, 120 -C32C- 85, 105, 135, 165
- C42C-105
- ★Please add "F" for the flange through tool coolant type.
- IT40-C20F- 90, 120*¹ IT50-C20F-105, 135, 165*¹
- C25F- 90, 120*¹ -C25F-105, 135, 165*¹
- C32F-105 -C32F-105, 135, 165
- C42F-120



High Speed Milling Chuck



GH Handle P.30

Code No.	MAX. (min ⁻¹)	Code No.	MAX. (min ⁻¹)
IT40X-C12- 65G, 90G	30,000	IT50X-C12-105G, 135G* ¹	20,000
-C16- 60G, 90G	25,000	-C16-105G, 135G* ¹	
-C20- 80G, 90G	25,000	-C20-105G, 135G* ¹	
-C25- 85G	20,000	-C25-105G, 135G* ¹	15,000
-C32- 95G, 105G		-C32- 85G, 105G, 120G	
		-C42- 95P* ² , 105P	

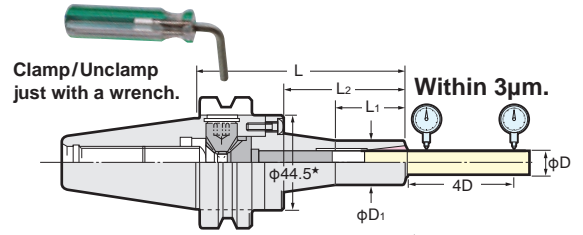
- ★For Milling Chucks except *2, Stopper for Direct Chucking, ONK Collet and OJK Collet can be used.
- ★The extended gauge length (L) is available. Please contact with us.
- ★The end mill shank tolerance is recommended to be h7.

IT MINI-MINI CHUCK

The best chuck for the small dia. cutting tool



MAX. 30,000min⁻¹ & G2.5
Gripping from Front Nose
Run-Out Accuracy : 3μm at 4D



★ : MMC12 = φ52.4

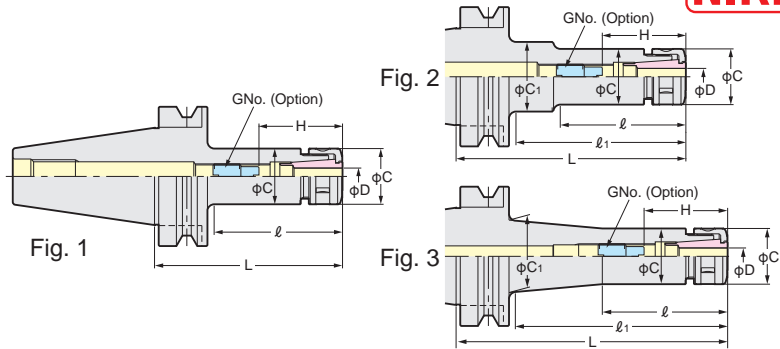
TAPER	Code No.	Chucking Range φD	L	φD ₁	L ₁	Collet	MAX.(min ⁻¹)	Weight(kg)
No.40	IT40X-MMC 4- 90	1~ 4	90	15	30	MPK 4	30,000	1.2
	-MMC 8- 90,120	2~ 8	90,120	20	33,40	PMK 8 VMK 8	30,000	1.4 , 1.5
	-MMC12- 90,120	4~12	90,120	30	35,60	PMK12 VMK12	30,000	1.7 , 1.8
No.50	IT50X-MMC 4-105	1~ 4	105	15	30	MPK 4	20,000	3.8
	-MMC 8-105,135,165	2~ 8	105,135,165	20	33,40,40	PMK 8 VMK 8	20,000	4.4,4.5,4.6
	-MMC12-105,135,165	4~12	105,135,165	30	35,60,70	PMK12 VMK12	20,000	4.6,4.7,4.8

★Wrench is supplied as standard. ★MPK, PMK, VMK collet is not included with MINI-MINI Chuck. Please refer P.32
★Please add "C" for the centre through tool coolant type. e.g. IT40X-MMC8C-90
★Please add "F" for the flange through tool coolant type; IT40X-MMC 8F- 90,120 IT50X-MMC 8F-105,120
-MMC12F- 90,120 -MMC12F-105,120

IT SLIM CHUCK



High precision
High speed
Powerful gripping



When SK J type nut is used, the total chuck length will be extended by 6mm.

TAPER	Code No.	D	l	l ₁	C	C ₁	H	G No. (Option)	Weight (kg)	Fig.	SK Collet
No.40	IT40-SK 6- 60, 90,120,150	0.7~6.0	38,48,62,60	-,-,82,112	19.5	-,-,32,25	21~35	SKG- 8	1.0,1.1,1.2,1.4	1,1,2,3	SK 6
	-SK10- 60, 90,120,150,180	1.75~10.0	40,50,60,73,73	-,-,82,112,144	27.5	-,-,32,33.5,39	30~50	SKG-12L	1.1,1.2,1.4,1.6,1.7	1,1,2,3,3	SK 10
	-SK13- 60, 90,120,150,180	2.75~13.0	40,50,80,88,88	-,-,-,114,144	33	-,-,-,40,40	31~65	SKG-15	1.3,1.4,1.6,1.8,1.9	1,1,1,3,3	SK 13
	-SK16- 60*, 90,120,150,180	2.75~16.0	40,54,84,114,144	-	40	-	40~70	SKG-18L*	1.4,1.5,1.7,1.9,2.0	1	SK 16
	-SK20- 90,120	3.5~20.0	70,100	-	48.5	-	47~80	SKG-22	1.7,1.9	1	SK 20
	-SK25- 90,120	7.5~25.4	70,100	-	55	-	55~75	SKG-28	1.8,2.0	1	SK 25
No.50	IT50-SK 6-105,135,165,200	0.7~6.0	60,62,62,60	-,-,93,117,154	19.5	-,-,32,32,30	21~35	SKG- 8	3.7,3.9,4.1,4.3	1,2,2,3	SK 6
	-SK10-105,135,165,200	1.75~10.0	65,70,75,75	-,-,95,125,154	27.5	-,-,32,32,36	30~50	SKG-12L	4.2,4.4,4.6,5.0	1,2,2,3	SK 10
	-SK13-105,135,165,200	2.75~13.0	65,95,92,92	-,-,125,160	33	-,-,45,45	31~65	SKG-15	4.5,4.7,4.8,5.3	1,1,2,3	SK 13
	-SK16-105,135,165,200	2.75~16.0	65,95,90,90	-,-,125,160	40	-,-,50,50	40~70	SKG-18L	4.7,4.9,5.1,5.5	1,1,2,2	SK 16
	-SK20-105,135,165,200	3.5~20.0	65,95,125,160	-	48.5	-	47~80	SKG-22	4.8,5.1,5.4,5.8	1	SK 20
	-SK25-105,135,165,200	7.5~25.4	65,95,125,160	-	55	-	50~85	SKG-28	4.8,5.2,5.6,6.0	1	SK 25

★Dimension for IT40-SK16-60 marked *, H=50~65 and G No.=SKG-18S
★Collet, adjust screw (G No.) and spanner are available as an option.
The Code No. of the spanner is SK6 (C=φ18) : SKL-6, SK6 (C=φ19.5) : SKL-6W, SK10: SKL-10, SK13: 9HC12A, SK16: 9HC16, SK20: 9HC22, SK25: 9HC25
★Please refer P.39 for SK collet and please refer P.43 for J type nut.,
★Please add "C" for the centre through tool coolant type.

IT40-SK 6C- 90,120 IT50-SK 6C-105,165
-SK10C- 90,120 -SK10C-105,165
-SK13C- 90,120 -SK13C-105,165
-SK16C- 90,120 -SK16C-105,165
-SK20C- 90,120 -SK20C-105,165
-SK25C- 90,120 -SK25C-105,165

★Please add "F" for the flange through tool coolant type.

IT40-SK 6F- 90,120 IT50-SK 6F-105,165
-SK10F- 90,120 -SK10F-105,165
-SK13F- 90,120 -SK13F-105,165
-SK16F- 90,120 -SK16F-105,165
-SK20F- 90,120 -SK20F-105,165
-SK25F-120 -SK25F-105,165



High Speed SLIM CHUCK

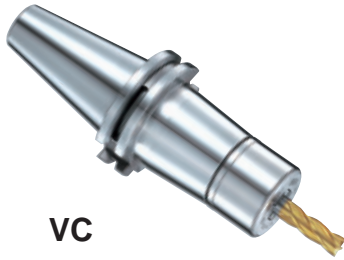


GH Handle P.30

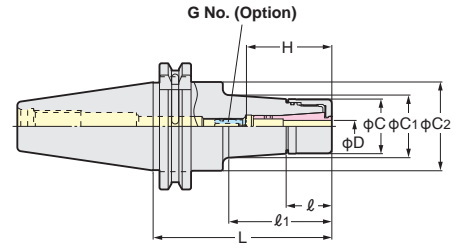
Code No.	MAX. (min ⁻¹)	Code No.	MAX. (min ⁻¹)
IT40X-SK 6- 60P, 90P, 120P	30,000	IT50X-SK 6-105P, 165P	20,000
-SK10- 60P, 90P, 120P		-SK10-105P, 165P	
-SK13- 60P, 90P, 120P		-SK13-105P, 165P	
-SK16- 60P, 90P, 120P	-SK16-105P, 165P		
-SK20- 90P, 120P	-SK20-105P, 165P		
-SK25- 90P, 120P	20,000	-SK25-105P, 165P	

★The extended gauge length (L) is available. Please contact with us.

IT ANNIVERSARY TYPE VC HOLDER



With TiN Bearing Nut
MAX.30,000min⁻¹ & G2.5
Run-Out Accuracy : 3μm at 4D



VC

TAPER	Code No.	D	L	ℓ	ℓ ₁	C	C ₁	C ₂	H	G No. (Option)	Weight (kg)	MAX. (min ⁻¹)	Collet		
No.40	IT40X-VC 6- 60	2.0~6.0	60	23	23	27.5	27.5	44.7	35~45	VCG 6- 8A	1.1	30,000	VCK 6		
	- 90		90		51.9		31.5				1.3				
	-120		120		81.9		35.7				1.5				
	-VC13- 60	3.0~12.0	60	29	29	40	40.0		50~60	VCG13-15A	1.2		1.5	1.9	VCK13
	- 90		90		70		44.7				1.5				
	-120		120		100		44.7				1.9				
No.50	IT50X-VC 6-105	2.0~6.0	105	23	64.9	27.5	33.4	70.1	35~45	VCG 6- 8A	3.9	20,000	VCK 6		
	-135		135		94.9		37.6				4.1				
	-165		165		124.9		41.8				4.4				
	-VC13-105	3.0~12.0	105	29	64.9	40	45.0		50~60	VCG13-15A	4.1		4.5	4.9	VCK13
	-135		135		94.9		49.2				4.5				
	-165		165		124.9		53.4				4.9				

- ★TiN Bearing Nut is supplied as standard.
- ★When the axial stopper is required, please use Adjust Screw (G No.)
- ★Please add "-RP" at the end of Code No. for Rust Proof Treatment VC Holder. e.g. IT40X-VC13-60-RP
- ★Please use VC J type Nut & Cap for Centre Through Coolant. When VC J type Nut is used, the total holder length will be extended to 6mm.
- ★Please refer P.34 for VCK Collet.

- ★IT40X-VC6-150, IT40X-VC13-150, IT50X-VC13-90, -120 are available as semi-standard.
- ★Collet, adjust screw (G No.) and GH Handle are available as an option. P.30
- ★All series are for High Speed Rotation.



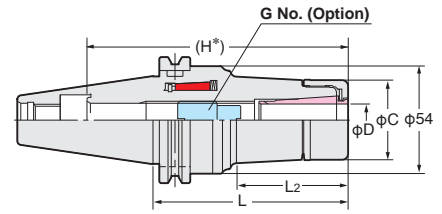
NIT MAJOR DREAM HOLDER



Difference of the swarfs



Please use Jet Coolant Splash for better swarf generation. P.34, P.43



(H*) : MAX. H without adjust screw.

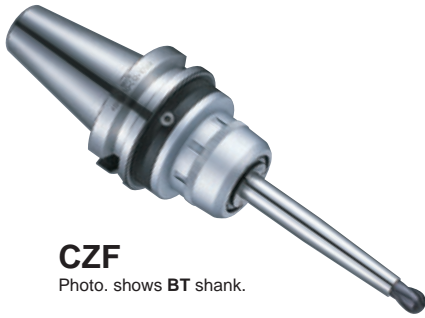
MDSK

TAPER	Code No.	D	L ₂	C	H*	H ₁	G No. (Option)	Weight (kg)	Collet
No.40	NIT40N-MDSK 6- 60, 75, 90	3.0~ 6.0	18,33,48	19.5	86,101,116	21~35	SKG- 8	0.8,0.9,1.1	SK 6-A
	-105,120		63,78		131,146			1.2,1.4	
	-MDSK10- 60, 75, 90,105	3.0~10.0	19,33,48,63	27.5	86,101,116,131	30~50	SKG-12L	1.1,1.3,1.5,1.6	SK10-A
	-120,150,180		78,110,141.2		146,176,206			1.8,2.2,2.4	
	-MDSK13- 65, 75, 90,105	3.0~13.0	24,33,48,63	33	86,101,116,131	31~60	SKG-15	1.2,1.4,1.7,1.8	SK13-A
	-120,150,180		78,110,144		146,176,206			2.0,2.4,2.6	
	-MDSK16- 65	3.0~16.0	24	40	86	45~60	SKG-18L	1.2	SK16-A
	- 75, 90,105		33,48,64		101,116,131			1.5,1.9,2.0	
	-120,150,180		80,113,144.6		146,176,206			2.2,2.5,2.8	
	-MDSK20- 75, 90	4.0~20.0	41.2,55	48	80,95	50~73	SKG-12,SKG-12-55L	1.9,2.1	SK20-A
-105,120	70,85		110,125		2.3,2.6				
No.50	NIT50 -MDSK 6-105,120,135	3.0~ 6.0	48,63,78	19.5	116,131,146	21~35	SKG- 8	3.6,3.7,3.9	SK 6-A
	-MDSK10-105,120,135		3.0~10.0		48,63,2,78.2			27.5	
	-165,195	110.2,141.2		176,206	5.0,5.3				
	-MDSK13-105,120,135	3.0~13.0	48,63,78	33	116,131,146	31~60	SKG-15	4.2,4.7,5.0	SK13-A
	-165,195		110,144		176,206			5.3,5.6	
	-MDSK16-105,120,135	3.0~16.0	48,64,80.1	40	116,131,146	45~70	SKG-18L	4.1,4.9,5.2	SK16-A
	-165,195		114.7,144.6		176,206			5.5,5.8	
	-MDSK20-105,135		4.0~20.0		42,72			48	
	-165,195	102,132		205,235	5.9,6.7				
	-MDSK25-105,135	8.0~25.4		42,74	55	159,175	55~85		SKG-28
-165,195	105,135		205,235	6.5,7.5					

- ★Please use A type SK collet that is available as an option for end milling operation. P.39
- ★Please refer P.43 for Jet coolant J type nut and cap.
- ★GH Handle is available as an option. P.30 Please order with the Code No. GH10 : MDSK10, GH16 : MDSK16, GH20 : MDSK20, GH25 : MDSK25.
- ★Please add "P" at the end of Code No. for high speed holder, e.g. NIT40N-MDSK10-60P.
- ★φC₂ of NIT40N is larger than the dimension of the IT40 standard.

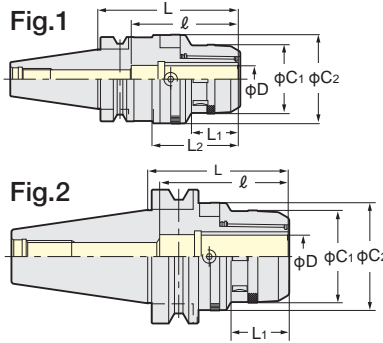


IT ZERO FIT TYPE MILLING CHUCK

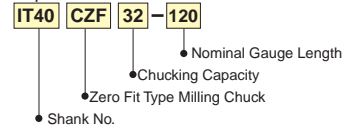


CZF

Photo. shows BT shank.



Explanation of the Code No.



TAPER	Code No.	C1	C2	L	L1	L2	l	Weight (Kg)	Fig.	Collet
No.40	IT40-CZF20-105	51.5	66.5	105	35	70	80	2.1	1	KM20 CCK20
	-CZF25-105	59.5	74.5	105	35	70	80	2.4		KM25 CCK25
	-CZF32-120	69	80.5	120	42	85	105	2.8		KM32 CCK32
No.50	IT50-CZF20-105	51.5	66.5	105	35	-	80	4.7	2	KM20 CCK20
	-CZF25-105	59.5	74.5	105	35	-	80	5		KM25 CCK25
	-CZF32-120	69	80.5	120	42	-	105	5.3		KM32 CCK32

★Spanner is available as an option.

CZF20 type : 9HC22, CZF25 type : 9HC25, CZF32 type : 9HC32

★Please note that the acceptable shank tolerance is $h_6 \sim h_7$.

★Please add "P" at the end of Code No. for the high speed type. e.g. IT40-CZF25-105P

★Wrench to adjust run-out (9ZFL) is available as an option.

★Please refer P.31, P.32 for KM, CCK collet.

Wrench to adjust
9ZFL

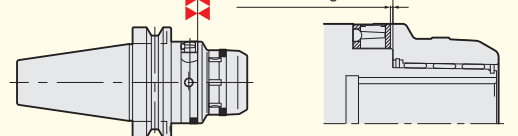


★For How to Adjust the Run-Out, please refer P.156.

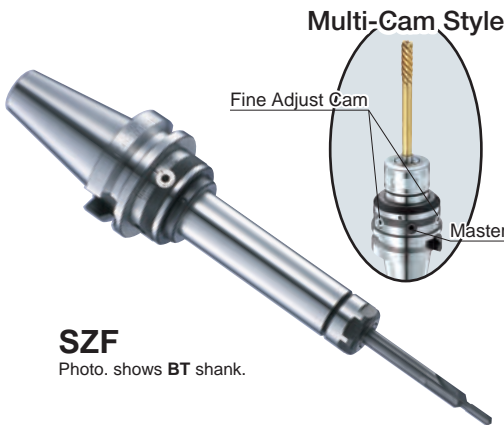
- In case of CZF (Milling Chuck) style, please rotate the Adjust Cam to the free position. Then, tighten the nose ring until face contact. If the face contact is not completed, the Adjust Cam can not function. (Free run) If the Adjust Cam is not at the free position before tightening, you can not tighten the nose ring until face contact correctly.
- For the safety reason, the Cam Ring Lock Screws can not be loosen to remove to the outside. Please loose the Cam Ring Lock Screws slightly to rotate the Cam Ring.

Please make sure the nose ring contacts with the chuck body perfectly

There are clearance between Nose Ring and Cam Ring



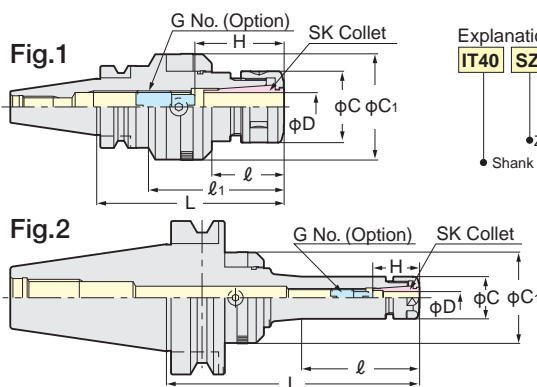
IT ZERO FIT TYPE SLIM CHUCK



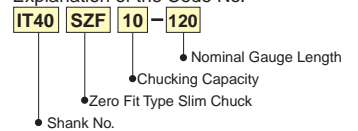
SZF

Photo. shows BT shank.

Multi-Cam Style



Explanation of the Code No.



TAPER	Code No.	D	L	l	l1	C	C1	H	G No. (Option)	Weight (Kg)	Fig.	Collet
No.40	IT40-SZF 6- 90, 150	0.7~6.0	90, 150	45, 89	-	19.5	40.5	21~35	SKG- 8	1.3, 1.7	2	SK 6
	-SZF10-120, 150	1.75~10.0	120, 150	57, 87	-	27.5	48.5	30~50	SKG-12L	1.6, 1.9	2	SK10
	-SZF16-120, 150	2.75~16.0	120, 150	51, 81	-	40	59.5	40~70	SKG-18L	1.9, 2.2	2	SK16
	-SZF25-120, 150	16.0~25.4	120, 150	49, 79	85, 115	55	66.5	55~85	SKG-28	2.4, 2.9	1	SK25
No.50	IT50-SZF 6-105, 165	0.7~6.0	105, 165	60, 67	-	19.5	40.5, 59.5	21~35	SKG- 8	4.0, 4.2	2	SK 6
	-SZF10-105, 165	1.75~10.0	105, 165	60, 65	-	27.5	48.5, 59.5	30~50	SKG-12L	4.5, 4.9	2	SK10
	-SZF16-105, 165	2.75~16.0	105, 165	60, 120	-	40	59.5	40~70	SKG-18L	5.0, 5.4	2	SK16
	-SZF25-120, 165	16.0~25.4	120, 165	75, 120	-	55	66.5	55~85	SKG-28	5.7, 6.0	2	SK25

★Adjust screw (G No.), wrench to adjust run-out (9ZFL) and SKL spanner are available as an option. SZF6: SKL-6W, SZF10: SKL-10, SZF16: 9HC16, SZF25: 9HC25

★Please use "P" class or "A" type SK collet. P.39

★For centre through coolant application please use SK J type nut and cap for your preference. Please note that the length of J type nut is 6mm longer than the standard SK nut.

★For High Speed type, Code No. is "GSZF-P". e.g. IT40-GSZF10-120P

★For How to Adjust the Run-Out, please refer P.156

★Multi-Cam style is available. e.g. IT40-SZF16-120-C3. (3 Cams) Please contact us for more detail.

UNIVERSAL MICRO TOUCH

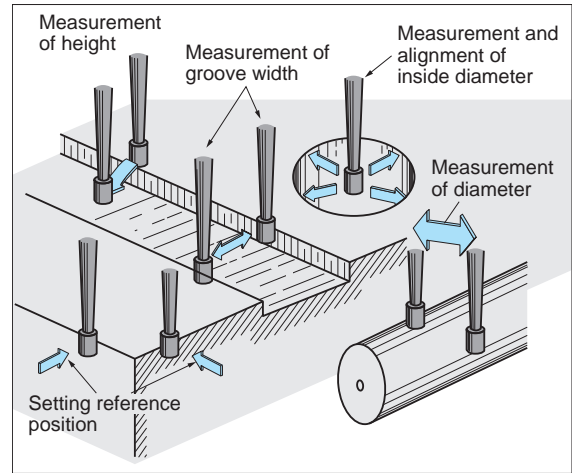


3D Electronic Edge Detector of Basic Point

- Precision Touch Sensor
Repeatability ± 2 micron.
- Long Safety Over-Travel Distance protects from damage. X, Y = ± 7 mm Z = 3mm
- Red lamp and electronic beep sound notice the touching position. When touching to the work piece, red lamp immediately lights up all around. The one with BT shank gives the electric beep sound also to make double notices.

How to obtain touching position

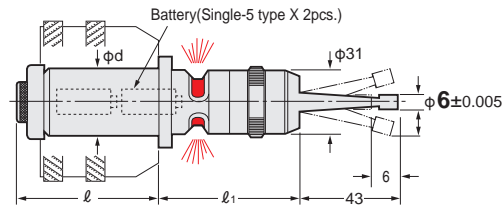
Make the stylus slowly get near to the measuring surface of work piece and the red lamp will light at the moment when the former touches the latter. A position where 3mm is compensated from that position (because of 6mm stylus diameter), is the touching position to be obtained.



Straight Shank UMT MICRO TOUCH



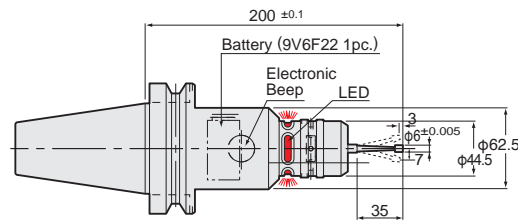
UMT



Code No.	ϕd	l	l_1	Weight (Kg)
S20-UMT	20	68	61	0.4
S32-UMT	32	65	65	0.7
MT2-UMT	MT2	66.5	75	0.4

★Ball type $\phi 6$ mm stylus is also available : S32-UMTB

BT-UMT-W MICRO TOUCH



TAPER	Code No.	Weight (Kg)
No. 30	BT30-UMT200W	2.1
No. 40	BT40-UMT200W	2.7
No. 50	BT50-UMT200W	5.0

★Ball type $\phi 6$ mm stylus is also available : BT40-UMTB200
★IT40-UMT200W and IT50-UMT200W are also available.

BT-UMTH MICRO TOUCH for ring sensor

For Machining Centre with ring sensor, the electric circuits are different from standard, please purchase this through M/C Builder.



Universal Micro Sensor



UMS

- Repeatability ± 1 micron
- Perfect water/dust proof
- Inductive signal transmission type (No need for battery)
- The sensor signal can be managed with ultra high speed.
- Because of its internal circuit contact type, this sensor can be used for any materials of components.
- Interchangeable stylus. 50mm (standard), 100mm (Option)

BT30-UMS200

BT40-UMS200

BT50-UMS200

Please contact with us for more details.

Specification	
X-Y Over-Travel	10mm
Z Over-Travel	6mm
Stylus	$\phi 6$ Ball
Transmission	Inductive

MEASUREMENT

Internal Contact System - can be used for not conductive work piece.

- Precision Touch Sensor
Repeatability ± 2 micron.
- Long Safety Over-Travel Distance protects from damage. X, Y = ± 7 mm Z = 3mm
- Not conductive work piece can be measured. Internal contact system is built-in.
Blue lamp and electronic beep sound notice the touching position. After touching to the work piece, blue lamp lights up all around. The one with BT shank gives the electric beep sound also to make double notices.

How to obtain touching position

Make the stylus slowly get near to the measuring surface of work piece and the blue lamp will light at the moment when the former touches the latter. A position where 2mm is compensated from that position (because of 4mm stylus diameter), is the touching position to be obtained.



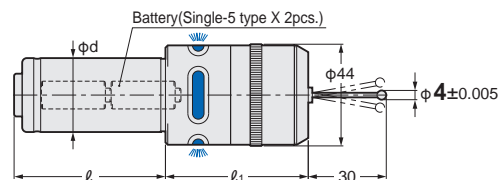
Photo shows with ruby stylus (option).

Straight Shank UMTX MICRO TOUCH



UMTX

Ruby stylus is available as an option.



Code No.	ϕd	l	l_1	Weight (Kg)
S20-UMTX	20	68	64	0.5
S32-UMTX	32	65	64	0.8
MT2-UMTX	MT2	66.5	64	0.5

★ $\phi 4$ mm steel stylus and battery are supplied as standard.

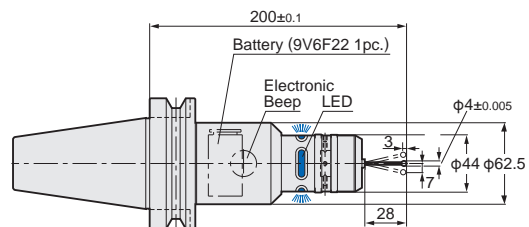
★ The delay of the system is within 0.01mm, because of the internal contact system.

BT-UMTX MICRO TOUCH



BT-UMTX

Ruby stylus is available as an option.



TAPER	Code No.	Weight (Kg)
No. 30	BT30-UMTX200W	2.3
No. 40	BT40-UMTX200W	2.9
No. 50	BT50-UMTX200W	5.2

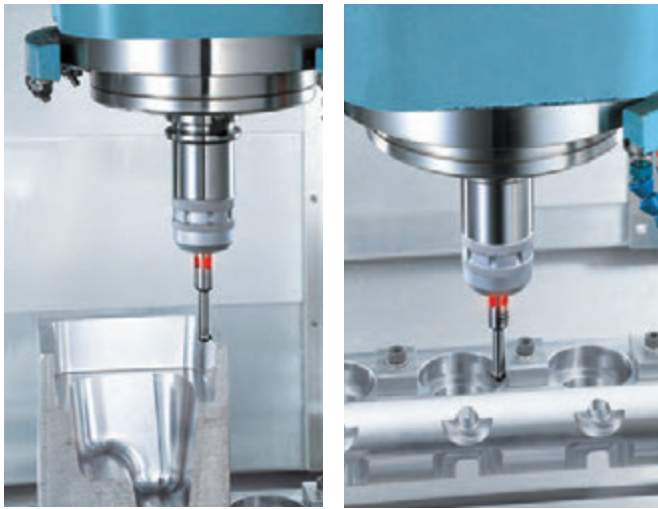
★ $\phi 4$ mm steel stylus and battery are supplied as standard.

★ The delay of the system is within 0.01mm, because of the internal contact system.

Specification

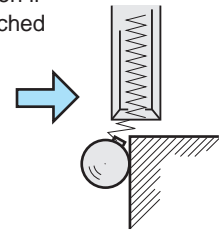
Measuring Pressure	X, Y = 0.35N Z = 0.8N	
Battery	Straight Shank	An alkali dry cell Model 5 1.5V 2pcs
	BT Shank	Manganese dry cell 6F33 X 9V 1pcs
	36 Hours	
Stylus	Standard : $\phi 4$ mm steel stylus Option : $\phi 4$, $\phi 3$, $\phi 2$ and $\phi 1$ mm ruby stylus The ruby stylus can not be ordered alone. Please order the Micro Touch with the ruby stylus. When ordering, please add (RB○) at the end of the Micro Touch Code No.	
	<p>e.g. BT30-UMTX200W (RB2) └─ With $\phi 2$mm ruby stylus</p> <p>S32-UMTX (RB4) └─ With $\phi 4$mm ruby stylus</p>	

High Sensitive Position Sensor

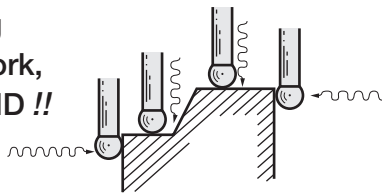


- Instant Indication of red LED Lamp.
- Instant Indication by red LED lamp at very light contact of Sensor Ball with Workpiece.
- Ideal for Centre Detecting with Milling Machine, Boring Mill, Drilling Machine and Machining Centre.
- Repeatability: within 2 micron.
- Safety Mechanism against Overrun !!

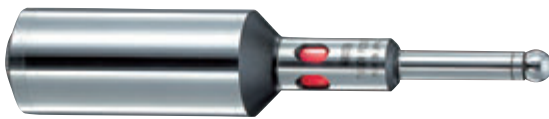
The ball is pulled up by spring. Even if overrun happens, ball will be detached from the ball seat.



- Easy Checking Location of Work, Face, OD and ID !!

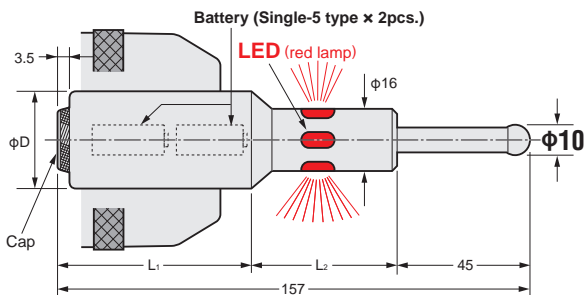


- Straight Shank TOUCH POINT



TP

- Can be connected to NIKKEN Milling Chuck C20, C32



Code No.	φD	L ₁	L ₂	Weight (Kg)
TP-20	20	77	35	0.2
TP-32	32	71	41	0.5

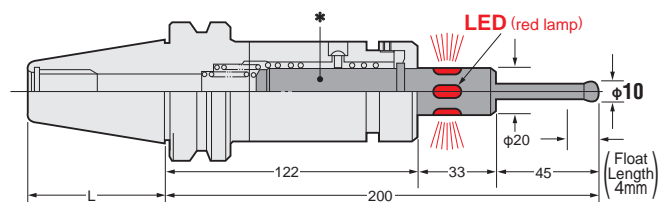
★No Z-axis float in straight shank type TOUCH POINT.
If float is needed, please order UMT series (S20,S32-UMT). 参考 P.127

- TOUCH POINT for machining centre (with Z-axis Float Mechanism)



BT-TP

- The Ball End is located 200mm distant from Gauge Line, and can be used as Gauge Line Reference of Z-axis. Ultra precision Float Mechanism in the Thrust Direction enables Soft Touch Detection.



TAPER	Code No.	L	Float Length	Weight (Kg)
No.40	BT40-TP200	65.4	4	1.9
No.50	BT50-TP200	101.8	4	4.5

★No applicable to Non-conductive work piece (Plastic, Bakelite and so on).
★Included Battery (Single-5 type x 2pcs.)
★IT40-TP200 and IT50-TP200 are also available.
★The Code No. of Touch Point marked * for the spare part is 9TP200S.

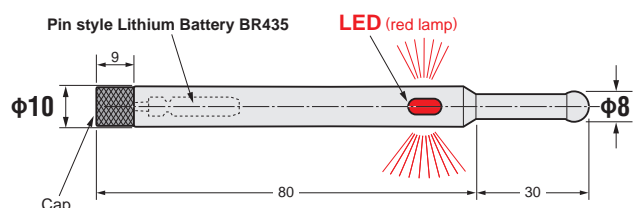
NEW

- φ10 Shank TOUCH POINT



S10-TP8

- Compact and slim type.
- It can be used for the narrow space and deep groove.
- It's suitable for HSK25A, 32A, 40A and 50A.
- No Z-axis float.



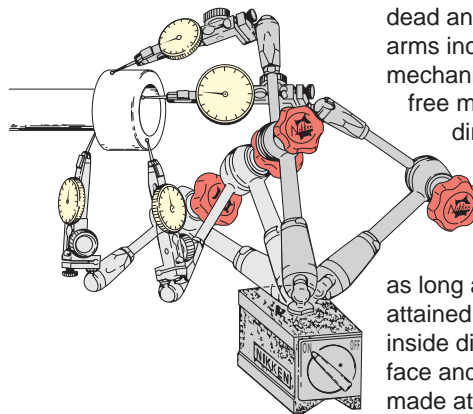
MEASUREMENT

UNIVERSAL MICRO STAND

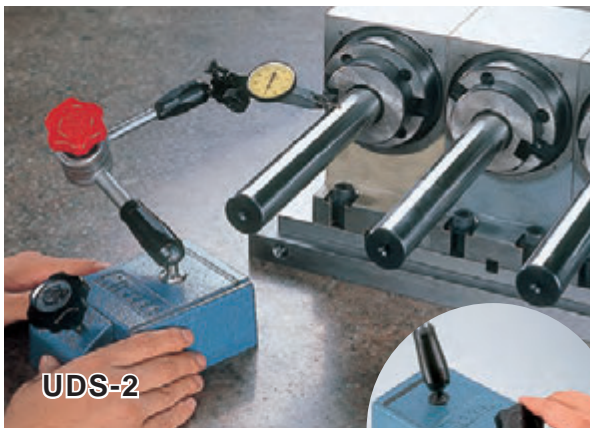


UDS-1

Long Reach 300mm



Free flexing with single knob, no dead angle and long reach, two arms incorporating ball joint mechanism at both ends provide free movement in any direction such as vertical, lateral, longitudinal or rotational etc. If stretched horizontally, a reach as long as **300mm** can be attained. Measurements of inside dia., outside dia., end face and back face etc, can be made at will.



UDS-2

Remote Fine Adjusting Knob (UDS-2)

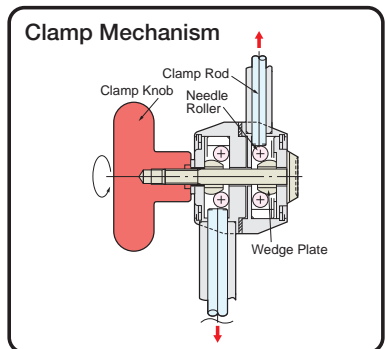
The base is made by heavy and precision casting and arms are clamped by a remote knob with fine adjustment. Measurement position of dial gauge can be easily adjusted without losing setup of Universal Micro Stand.



Remote Adjusting Knob

New mechanism permitting no looseness due to vibration

By only tightening the single red clamp knob, all articulated joints are locked firmly and no fine (micron) movement will occur even after being left as they are for 100 hours.



Strong magnet base makes it possible to adapt to vertical, angular, uneven surface, etc.

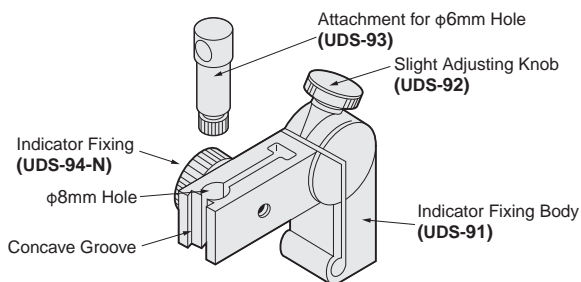


On M/C

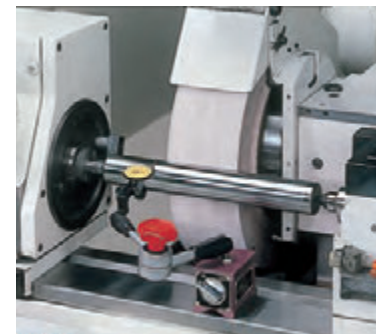
Code No.	Style
UDS-1	With magnet base
UDS-2	With precision casting base

★Dial gauge is supplied as an option.

Any dial gauge, pick tester can be connected with this attachment.



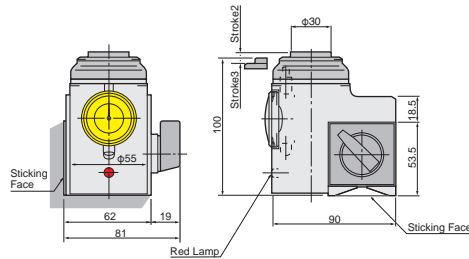
On NC Lathe



On Grinding Machine

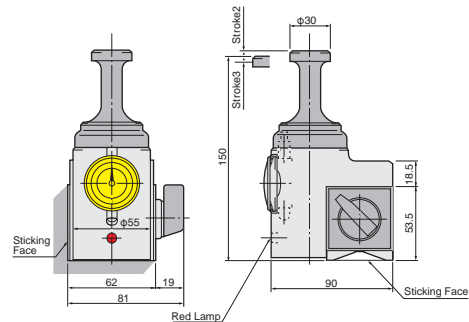


HP-100



★2 of Batteries LR44(HC) are supplied as standard with both of HP-100 and HP-150.

HP-150



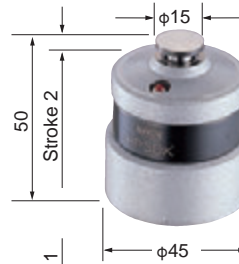
Reference point of work piece can be measured very quickly and accurately without damage of tool teeth.

- High Precision Measurement
- Easy to measure tooling off-set values on the machine accurately.
- Hard wearing powerful magnetic Base.
- Powerful magnetic base (700N) makes it suitable for use on manual machine as well as Vertical/Horizontal Machining Centres and NC Lathes.

■ Swarf Removal
The Magnetic Base can be switched on and off allowing the reference face to keep clean.

■ Plunger Head is given a Anti-Rust Rubber Seal.

■ Proximity Lamp
The red lamp is activated when the plunger comes within the measuring range of the reference height.



HP-50K
HEIGHT PRESETTER

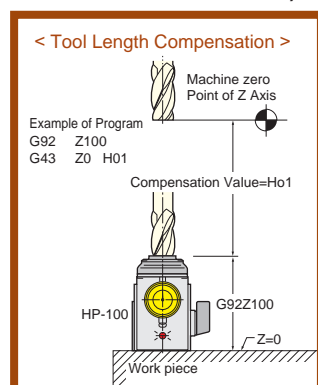


NEW
HP-50X
INTERNAL CONTACT TYPE
HEIGHT PRESETTER

- $\phi 0.2$ mm drill can be measured. (Feed rate must be lower than 5mm/min.)
- It can be used for not conductive machine and work piece.

Adjustment of Reference Point

No setting gauge plate is required to adjust Zero Point. Push Plunger down by hand, and adjust the large hand to the Zero Scale of Dial Gauge. The small hand indicates “-3” at this time.)



Example of usage at Vertical Machining Centre.



Example of usage at NC Lathe.



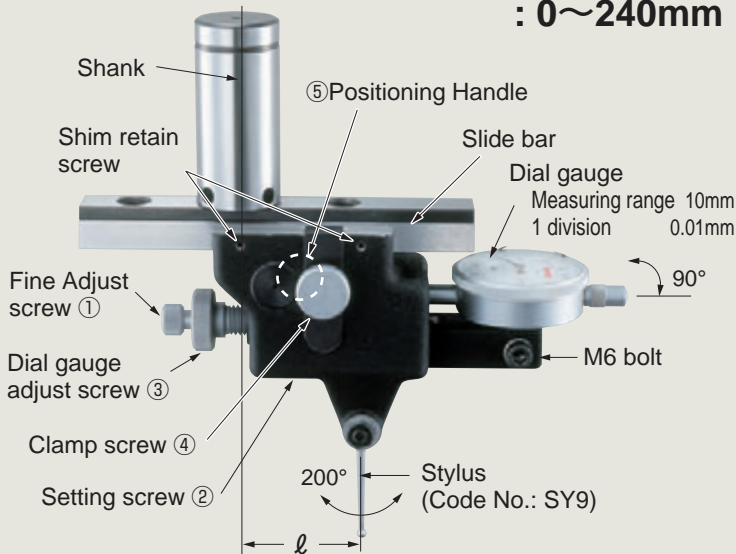
Also suitable for use of Micron Adjustment of Boring Arbor.

CENTERING HOLDER



SY

Large Measuring Range
: 0~240mm



- No need of changing the setting of dial Gauge. Only by turning Knob, ID, OD and Parallelism can be easily measured.
- Large measuring range. Cross moving distance of stylus is 120mm in radius.

Centering Holder Code No.	ID of Milling Chuck	Measuring Range
SY20-120	φ20	0~φ240
SY32-120	φ32	
SY42-120	φ42	

★0.01mm Dial Gauge is supplied as standard accessory.
★MT Shank (MT2~6), and IT Shank (#40/#50) are available.

Explanation of the Code No.

- SY 32 - 120
- MAX. Measuring Radius
 - OD of Shank : φ22, 32, 42
 - Symbol of Centering Holder

● Wide Range Measuring is possible both for ID and OD.



Parallelism Measuring



ID Centering



OD Centering

BALL CENTRALIZER

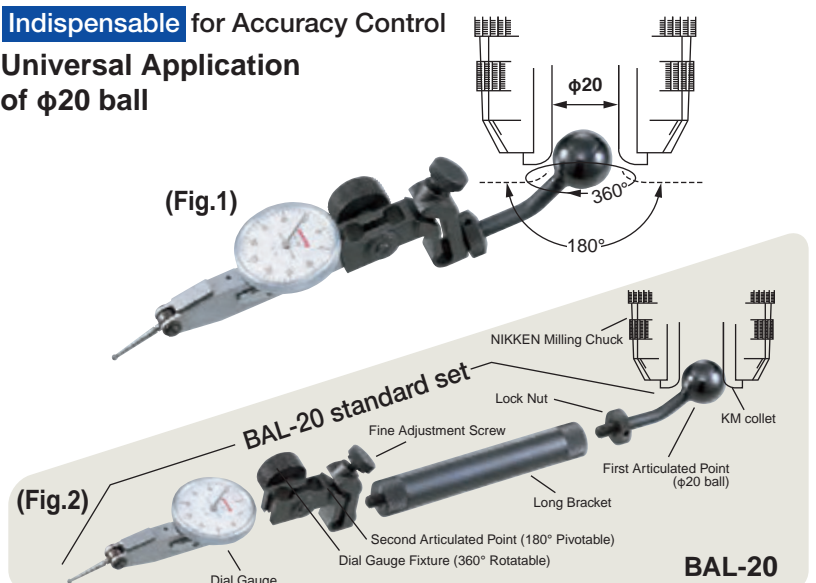


BAL



Centering of ID and OD can be done by the Ball Centralizer gripping into Nikken Milling Chuck.

Indispensable for Accuracy Control
Universal Application
of φ20 ball



■ 0.01mm dial Gauge is supplied as standard accessory.

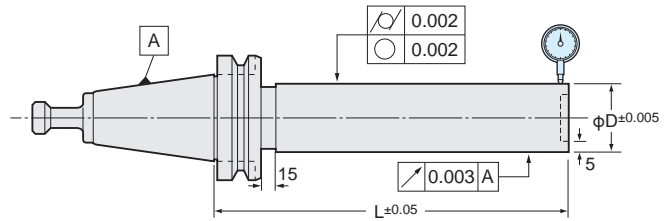
Code No.	Measuring Range	
	Using Fig.1	Using Fig.2
BAL-20	ID : φ3.5~φ320	ID : φ3.5~φ520
	OD : MAX. φ300	OD : MAX. φ500

MEASUREMENT

TEST BAR



Indispensable for checking your machine spindle.
Sub-zero treatment keeps accuracy to prevent from the deformation.
Each test bar is provided in a safety wooden box.



TB

Exact size of φD and L are marked on each test bar.

TAPER	Code No.	φD	L	Weight (Kg)	Run-out at total length	Circularity, Cylindricity
No.15	BT15BR-TB15-110	15	110	0.25	Within 0.003mm	Within 0.002mm
No.30	BT30-TB40-150	40	150	1.7		
No.40	BT40-TB40-200	40	200	2.7		
No.50	BT50-TB50-300	50	300	7.7		

- ★The code No. for Test Bar without flange is **AST** instead of **BT**. e.g. Test Bar for #40=AST40-TB40-200
- ★It comes with Pull Stud, please specify Pull Stud Code No. Please refer P.266 for Pull Stud.
- ★The different dimension of φD and L are available. e.g. BT50-TB50-40
But, the accuracy standard will be different. Please contact us.

The inspection certificate traceable to the national standard is available with charge.

Tool Wagon



TAPER	Code No.	Storage
BT30	TW30	60piece
BT40	TW40	48piece
BT50	TW50	40piece
NC5- 46	TW-NC5- 46	48piece
NC5- 63	TW-NC5- 63	48piece
NC5- 85	TW-NC5- 85	40piece
NC5-100	TW-NC5-100	40piece

- ★TW40 can be used for the Tool Wagon of NC5-46 and NC5-63 Tools with Reduction Bush TWP-NC5-46 and TWP-NC5-63.
- ★TW50 can be used for the Tool Wagon of NC5-85 and NC5-100 Tools with Reduction Bush TWP-NC5-85 and TWP-NC5-100.
- ★For the Code No. of Taper Cleaner, please add "-Taper No." at the end of "NTP-CLE".
e.g. NTP-CLE50



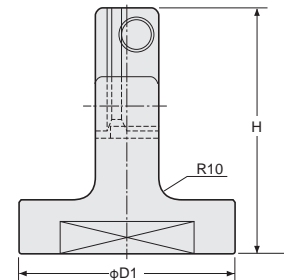
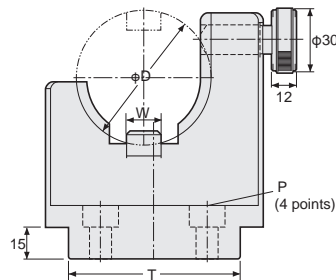
TW

Photo shows wagon with E236N.
E236N must be used on.

TOOL CLAMPER



NCL



Code No.	φD	W	φD1	H	T	P	Pitch	Remark
NCL-BT30	46	15.9	102	110	80	φ10.3 (M10)	50 × 60	
-BT40	63	15.9	102	115	80		50 × 60	NC5- 63 can be used
-BT45	85	19.2	115	124	90		60 × 70	NC5- 85 can be used
-BT50	100	25.6	130	133	100		70 × 80	NC5-100 can be used
NCL-NC5-46	46	12	102	110	80		50 × 60	
-IT50	97.5	25.6	130	133	100		70 × 80	
-ICAT40	63.55	15.9	102	115	80		50 × 60	IT40, CAT40
-CAT50	98.45	25.6	130	133	100		70 × 80	

★Please refer P.216 for the TCL-GH Tool Clasper.

NEW

TOOL PRESETTER E236N

NIKKEN



Economy Type

- **Rapid & Accurate Measurement Non-Contact Type**
C MOS Sensor
Autocollimation
(The cutting edge is detected automatically and displayed.)
Rapid Positioning & Fine Adjustment
- **Rapid Positioning & Fine Adjustment**
Granite Column and Base
- **Spindle can be exchanged.**
(BT, HSK, CAPTO TOOLING)
- **Fine and Easy Screen**
5.7" LCD Monitor (80 X 60mm)
Magnification: 20
- **Various Functions for Measurement**



Spindle (Option)



Printer WASP-PT



Measuring of the cutting edge



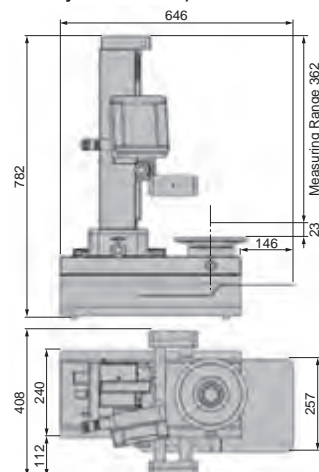
Angle of the cutting edge (Each 1 deg.)



Nose R of the cutting edge (Concentric circle by each 0.2mm)

E236N

Item	Contents	E236N-40	E236N-50
Measuring Range	X Axis: Dia. of Tool	0~φ260mm	0~φ260mm
	Z Axis: Length of Tool	30~360mm	30~360mm
MIN. Reading	Reading Method MIN. Reading	X Axis	Scale Counter 0.001mm (Radius)
		Z Axis	Scale Counter 0.001mm
Monitor		Magnification: 20 5.7" LCD Monitor	
Tool Clamp		Not installed	
Spindle		NT40	NT50
Master Gauge*1		GN40K	GN50K
Spindle (Option)		The spindle can be exchanged. NT40, 50, HSK32, 40, 50, 63, 80, CAPTO TOOLING C4, 5, 6 Z stroke will be shortened for HSK and CAPTO TOOLING.	
Reduction Sleeve (Option)		TN430 : NT40-NT30	TN540 : NT50-NT40
Power		AC100~230V	



- ★The spindle for HSK100A, CAPTO TOOLING C8, 3LOCK, NC5 can not be supplied, please select E238 presetter P.135
- ★Box size : W × H × D = 900 × 550 × 600mm, Box weight : 53Kg
- ★Printer (WASP-PT) and 10 pcs of the roll papers with seal (WASP-PTP) are available as an option.
- ★*1 Master gauge for BT40, BT50 are only standard accessory. Master gauge for HSK or CAPTO TOOLING is available as an option.
- ★Spindle for HSK32, 40, 50, 80 and CAPTO TOOLING C4, C5, C6 are order made spindles.

Working Desk E450N-STD (Option)

Working desk and the tool pot case (E450N-STD-MGH) can be supplied as an option. The tool pot case has 3 pots and the shank can be specified.
e.g NT30-NT40-NT50



Spindle (Option)

Please add the shank No. at the end of "E236N-SP." for the Code No. of the spindle.
e.g E236N-SP-HSK63



Shank No.	Z Stroke (mm)
NT30	0~360
NT40	0~360
NT50	0~360
HSK32	0~358
HSK40	0~351
HSK50	0~343
HSK63	0~335
HSK80	0~333
C4	0~324
C5	0~315
C6	0~293

- ★Spindle can be exchanged. (BT, HSK, CAPTO TOOLING)
- In case of BT30, 40, 50 spindle
No tool clamping mechanism
- In case of HSK32, 40, 50, 63 and CAPTO TOOLING C4, 5, 6 spindle
Tool can be clamped just by one wrench, but Z stroke will be shortened.

MEASUREMENT

TOOL PRESETTER E238-MBT



- High Precision / High Accuracy
- Ground granite base and column.
- Wide and well-visualized screen - 5.4" LCD monitor
Zoom in/out for X20/X40. of Actual Size.



E238-MBT



Display of angular grid (1 degree increment) for inspection of Tool cutting edge

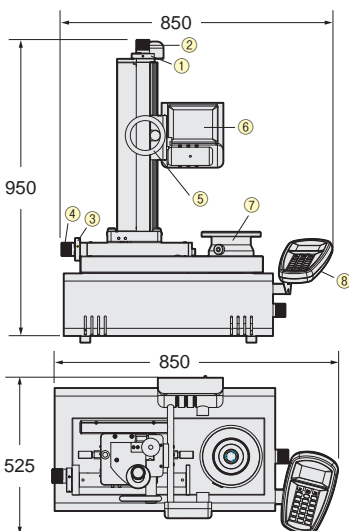
Display of reference circles for measurement of Nose Radius.

- Rapid and Accurate Measuring - Mechanism for switching between rapid positioning and fine adjustment.
- Exclusively designed for multiple function tool measuring system rather than just measuring the length and diameter.
 - Automatic measurement (Automatic scanning of the tool edge)
 - Display of angular grid (1 degree incremental) for checking the tool edge.
 - Display of reference circle for checking Nose R.
 - Multiple calculation functions
e.g. calculation for radius from 5 points, angle from 2 lines, or distance of 2 points
- Tool Management System "TOOLIVE"

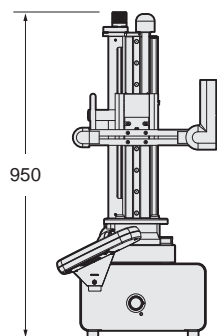
Item	Contents	E238-MBT40	E238-MBT50
Measuring range	X Axis : Diameter of Tool	0~φ280mm	0~φ280mm
	Z Axis : Length of Tool	45~380mm (145~480mm)*1	45~380mm (145~480mm)*1
Min. reading increment	Reading Method Min. reading	X Axis	Scale Counter 0.001mm (Radius) Radius / Diameter Chengable
		Z Axis	Scale Counter 0.005mm
CCD Camera		x20 / x40 5.4" LCD Monitor	
Spindle Clamp		Tool Clamp unit for 3Lock (MBT40, MBT50)	
Inter-changeable Spindle (other sizes available as optional extras)		NT40	NT50
Master Gauge		GMBT40	GMBT50
Reduction Sleeve (Option)		TN430 : NT40-NT30	TN540 : NT50-NT40
Interface.		RS232C (Optional accessory)	
Power supply		AC100 / 110V	

★*1 Extended Z axis of 145~480mm is available as an option. Please add "L" at the end of Code No. e.g. E238-MBT50-L.

★TOOLIVE software with interface function is only available in English Language. Minimum Computer Requirement : 486DX or above (Pentium 90 recommended) , 8MB RAM (16MB recommended) , 15 MB free space on HDD, Windows 95 or above, Mouse.



- ① Z Axis Rapid/Fine Changable Clutch
- ② Z Axis Fine Adjustment Knob
- ③ X Axis Rapid/Fine Changable Clutch
- ④ X Axis Fine Adjustment Knob
- ⑤ Z/X Axis Rapid Positioning Handle
- ⑥ 5.4" LCD Monitor
- ⑦ Spindle
- ⑧ Operation Panel



E450 with Working Desk



Tool Pot Case E450N-STD-MGH

Working Desk E450N-STD

TOOL PRESETTER E450N

NEW

NIKKEN

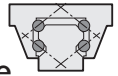


E450N

■ Touch Panel Display with Quick & Easy Operation



■ Super Precision & High Accuracy
Granite Column and Base
Double Circulation Ball Bearing Guide



■ Non-Contact Type Fine Screen -10.4" LCD Monitor
Magnification: X35
Changeable of C MOS Sensor/ Micro Scope

C MOS Sensor

Micro Scope



■ Rapid & Accurate Measurement
Changeable Clutch of Rapid/Fine Feed

■ Vacuum Clamp System Independent from the pull stud type.

The mechanical tool clamp system is installed on E238 for the double face contact tool such as 3LOCK tool, NC5 tool or HSK tool.

■ Tool Management System "TOOLIVE"

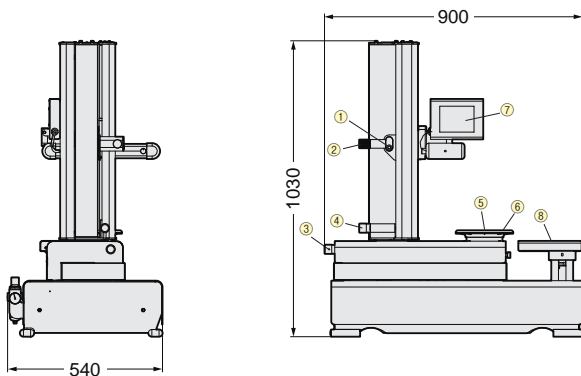
M/C data: MAX.1000

The management of the difference of the gauge line of M/C can be done.

Tool Set (Layout) Data: MAX.1000

Tool Data: MAX.1000

Item	Contents	E450N-40	E450N-50
Measuring range	X Axis : Diameter of Tool	0~φ400mm	0~φ400mm
	Z Axis : Length of Tool	35~500mm	35~500mm
Min. reading increment	Reading Method Min. reading	X Axis	Scale Counter 0.001mm (Radius) Changable of Radius/Diameter
		Y Axis	Scale Counter 0.001mm
Monitor		Magnification: X35 Changable of C MOS Sensor/ Micro Scope 10.4" LCD Monitor	
Tool Clamp		Vacuum Clamp (Air: 0.5MPa) The mechanical tool clamp system ※1 is available as an option.	
Spindle		NT40	NT50
Master Gauge		GN40K	GN50K
Reduction Sleeve (Option)		TN430V : NT40-NT30	TN540V : NT50-NT40
External Output		RS232C (option)	
Power		AC100~230V	

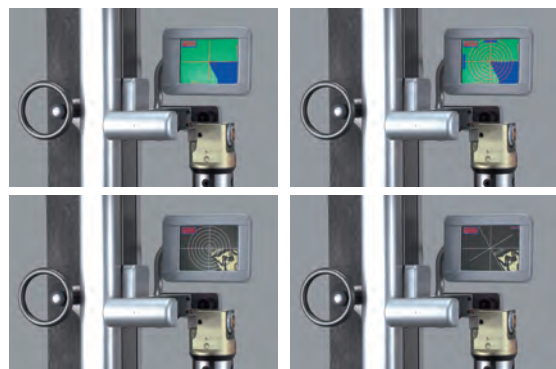


- ① Z/X Axis Rapid Positioning SW
- ② Z/X Axis Rapid Positioning Handle
- ③ X Axis Fine Adjustment Knob
- ④ Z Axis Fine Adjustment Knob
- ⑤ Spindle
- ⑥ Handle for Spindle Rotation
- ⑦ 10.4" LCD Monitor
- ⑧ Operation Panel

Box size: W X H X D: 1,100 X 1,200 X 700mm
Presetter Weight: 145Kg, Box Weight: 170Kg

■ Exclusively designed for multiple function tool measuring system rather than just measuring the length and diameter.

- Automatic measurement (Automatic scanning of the tool edge)
- Display of angular grid (1 degree incremental) for checking the tool edge.
- Display of reference circle for checking Nose R.
- Multiple calculation functions
e.g. calculation for radius from 5 points, angle from 2 lines, or distance of 2 points



MEASUREMENT

TOOL PRESETTER NTP300, 400, 500

NIKKEN



NTP

Photo shows **NTP400XZ-50**

■Deluxe type Tool Presetter. Best to increase the productivity of expensive machining centre

- Large Measuring Range: Diameter: $\phi 300\sim 500$ / Length: 500mm, 600mm
- Opto-Fiber System Projector. Bright and least burning of bulb. (Only for **NTP400**)

NTP300: $\phi 80\times 10$
NTP400: $\phi 116\times 10$ ($\phi 180\times 20$ Option)
NTP500: $\phi 180\times 20$

- Fast and smooth approach from a distance can be achieved with 2 speed motor.
- Pneumatic Tool Attaching Device ensures Safety and Sureness in Accuracy and Operation.
- High Precision Scale Counter is provided to both axes.

Explanation of the Code No.

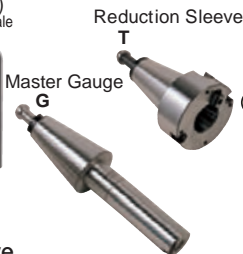
NTP400 XZ - 50 - PS6

- Pull Stud No. (The Pull Stud of Master Gauge is ground after assembly in order to maintain the highest accuracy. Please specify the Pull Stud No. which you use most often. The Master Gauge will be supplied with the indicated Pull Stud.)
 - Spindle Taper 30 : BT30
40 : BT40
50 : BT50
 - Kind of Counter Unit xz : 2 Axes Display
- NTP300 Tool Presetter
 NTP400 Tool Presetter
 NTP500 Tool Presetter

Item	Contents	NTP300XZ-50(40)	NTP400XZ-50(40)	NTP500XZ-50(40)
Measuring Range	X axis:Diameter of Tool Z axis:Length of Tool	D= 0~ $\phi 300$ mm L=50~ 500mm	D= 0~ $\phi 400$ mm L=50~ 500mm*	D= 0~ $\phi 500$ mm L=50~ 600mm
Min. Reading Unit	Reading Method Readable Unit	X axis	Digital Display 0.002mm(Diameter) or 0.001mm(Radius)	
		Z axis	Digital Display 0.001mm	
Min. Reading of Indicator		X axis	0.001mm	
		Z axis	0.01mm	
Spindle Taper		Select one from BT30/40/50 or IT40/50 (for NC5-46/63/85/100 is also available.)		
Master Gauge		$\phi 40\times 150\ell$ of the selected shank is supplied as standard. e.g.) for BT50 Spindle, ISO50- $\phi 40\times 150\ell$ is supplied.		
Power Supply	for Axis Driving and Projector	AC100V 50/60Hz 0.5KVA		AC200/220V 50/60Hz 1.2KVA
Air Pressure	for Tool Attaching Device	0.4~0.7MPa		
Net Weight and Packing		Net:300kg Gross:390kg Wooden Crate : 1220(W) \times 950(L) \times 1850(H)mm	Net:400kg Gross:480kg Wooden Crate : 800(W) \times 1200(L) \times 1900(H)mm	Net:700kg Gross:800kg Wooden Crate : 1800(W) \times 1400(L) \times 2400(H)mm
Standard Accessories		Motor Driving System, Pneumatic Tool Attaching Device, Projector, Spindle Cleaner, Levelling Bolts		
Optional Accessories		Reduction Sleeve, Extra Master Gauge, Special Color, RS-232C(for Interface with PC), Remote Control Cable, TMS System, Tool ID, Projector($\phi 180\times 20$)		

★NC5 and 3Lock are available. ★Reduction sleeve for NC5 : NT40-NC5-46, 63, NT50-NC5-46, 63, 85, 100
 Reduction sleeve for 3Lock : NT40-MBT40, NT50-MBT40, MBT50

$\times 20$ Projector (Option)
 $\phi 180$ mm Screen with Side Scale

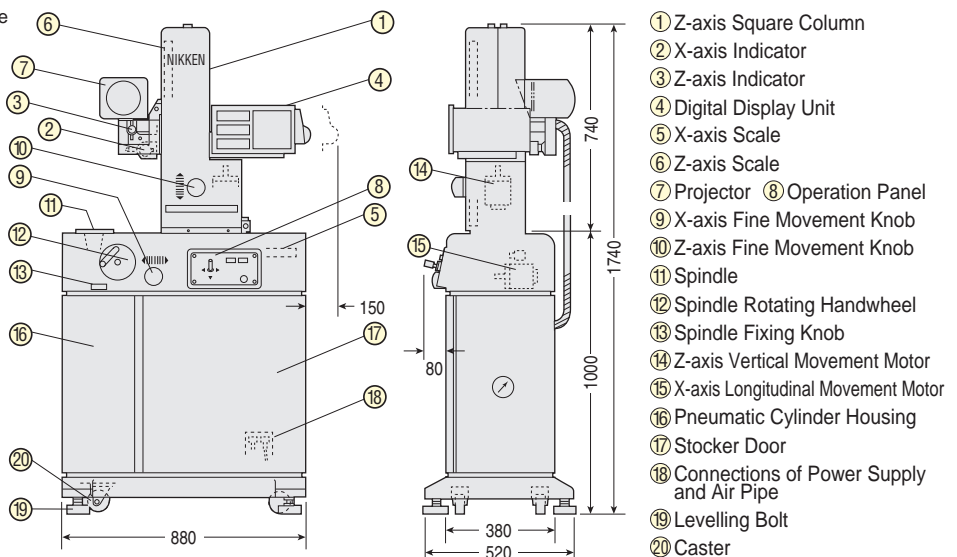


Reduction Sleeve

Code No.	OD	ID
T430	NT 40 - NT 30	
T530	NT 50 - NT 30	
T540	NT 50 - NT 40	

Reduction Sleeve

Code No.	TAPER	ϕD	L
G30	NT 30 - $\phi 30$	-150mm	
G40	NT 40 - $\phi 40$	-150mm	
G50	NT 50 - $\phi 40$	-150mm	

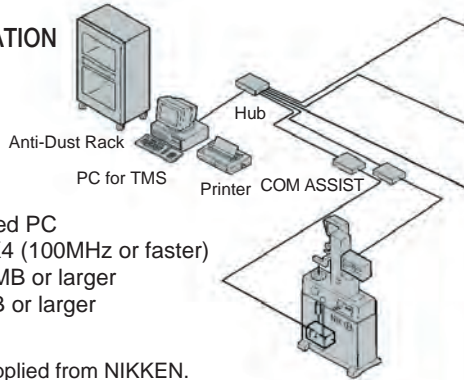


MEASUREMENT

TMS SYSTEM for Windows

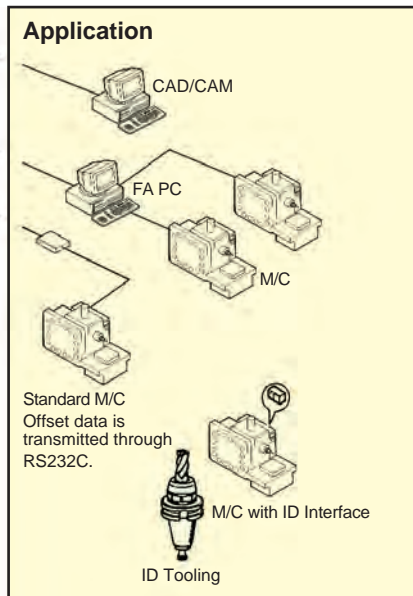


SYSTEM CONFIGURATION



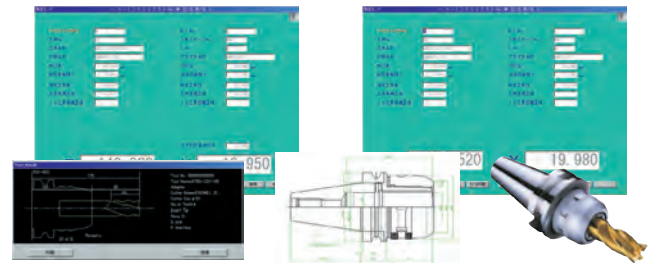
Recommended PC
 CPU : 486DX4 (100MHz or faster)
 Memory : 32MB or larger
 HDD : 100MB or larger

☐ can be supplied from NIKKEN.
 COM ASSIST is the converter from network I/F to RS232C I/F.
 Tool ID I/F is supplied as an option. PC, Hub, Printer and Anti-Dust Rack are supplied as an option. The system configuration differs depending on your application. Please contact with us for more detail.



Measuring Mode

The combination drawing of tooling and cutter, CAD drawing and photo can be confirmed before presetting the tool. The offset data can be calculated automatically according to pre-described formula as soon as the tool is measured. Read/ Write/ Initialize to ID, Label printing of Offset data, Cutter Inventory and some restriction for presetting (MAX. dia. or length checking) etc. can be done.



ID Mode

7 kinds of ID protocols are selected. (BALLUFF, OMRON etc.)

M/C Mode

Number of M/C : 1,000 or more M/Cs

Layout Mode

MAX. Tool Number per 1 Layout : 200 Tools
 Number of Layout : 10,000 or more Layouts
 Tool layout can be written by searching the registered tool data.
 Search/ Copy/ Merge of Layout Data, Tool List Printing and Output of Offset Data with G10 Format etc. can be done.



Tool Mode

Number of Tool : 20,000 or more Tools
 Tool data can be written by searching the registered cutter data. Copy/ Search of Tool Data and Automatic Cutting Condition Generation etc. can be done.

Cutter Mode

Number of Cutter : 20,000 or more Cutters
 Copy/ Search of Cutter Data and Cutter inventory etc. can be done.

Tool Group Mode

Number of Tool drawings : 80
 Number of Cutter Drawings : 99
 Number of combination drawings : 1,200
 The formula to calculate the offset data can be registered for the tool group.



Cutting Condition Mode

Offset Data Label Print

Label : A.ONE Computer Label 28105 (84x42mm)

Auto. Layout Generation from NC Program

Tool Life Management

Statistics Information

Utilities

■ means the optional function.
 * OS : Windows NT4.0, Windows 98, Se, 2000, XP
 * CD-ROM drive, Mouse and Network Board have to be installed on PC.
 * NTP300, 400 and 500 can be connected with TMS System.



MEASUREMENT

Windows NT4.0 and Windows 98, Se, 2000, XP are registered trade mark of Micro Soft.

3LOCK TOOLING SYSTEM

JAPAN, USA, KOREA PAT. EU PAT.P



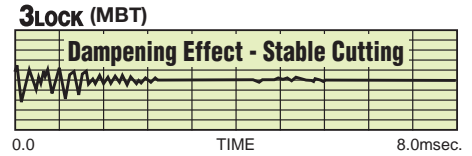
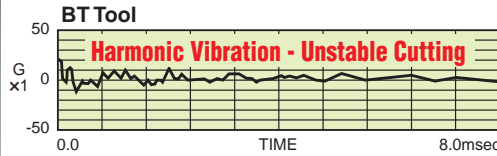
3LOCK (triple contact) can be done on the BT double face contact spindle.

High Speed

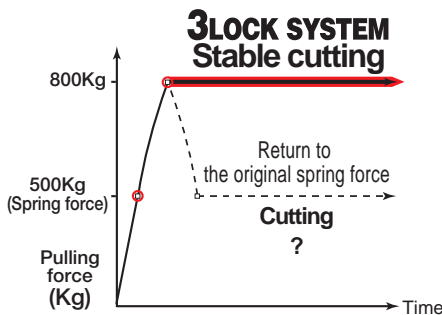
Tool Life
3 to 5 times

1. Power of Dampening Effect.

Performance enhancement due to the dampening effect are already universally recognized when using Nikken's DREAM-CUT Holder.
- Extended tool life of 3 to 5 times.

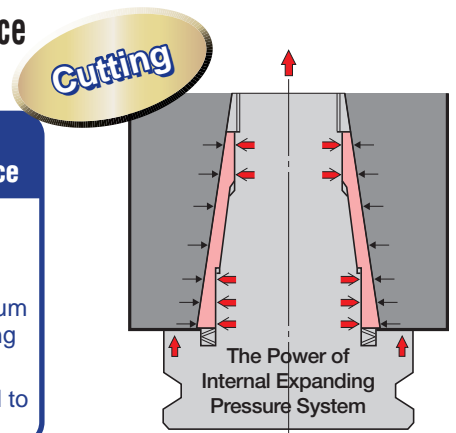


2. The mechanism which generates the excellent cutting performance -Internal Expanding Pressure System



Internal Expanding Mechanism System for instantly locking the maximum pulling force

- Tool clamping mechanism that use a disc springs experience lower clamping force during continuous use.
- **3LOCK** is a system for locking the maximum pulling force that is instantly produced during tool pulling.
- Cutting torque is greatly reduced compared to BT tooling for more comfortable cutting.



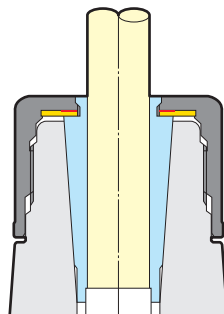
Machine spindle expansion due to the centrifugal force at the high speed rotation or heat expansion

3. The taper sleeve follows the expansion and maintains perfect contact with the taper and flange.

Taper Contact : Flange Contact = 90% : 10%

4. 2LOCK } Power of TiN Bearing Nut 3LOCK }

Rigidity



Run-Out Accuracy

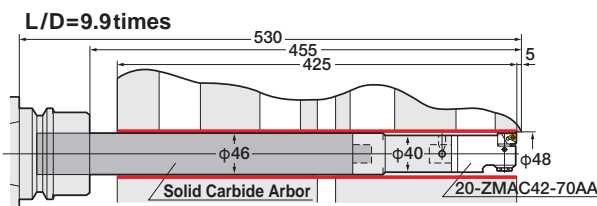
ATC Repeatability



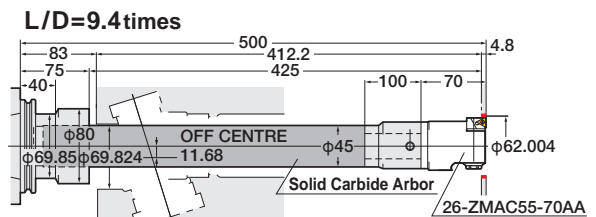
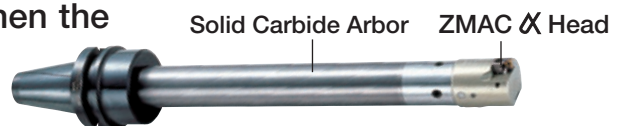
5. Excellent Rigidity

3LOCK tool performs the excellent rigidity, when the extended tool is used on the horizontal M/C.

Deep Hole Boring



Material: Aluminum
Stock Removal: 0.23~0.27mm/dia.
V : 450m/min.
S : 3,000min⁻¹
F : 180mm/min.



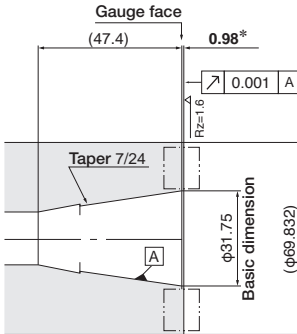
Material: Aluminum
Stock Removal: 0.5mm/dia.
V : 545m/min.
S : 3,000min⁻¹
F : 210mm/min.

BT DOUBLE FACE CONTACT SPINDLE

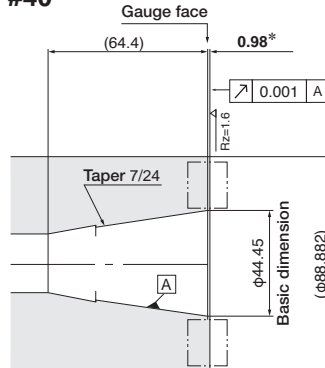


The NIKKEN **3LOCK** tooling can be used as the triple face contact (taper, flange and internal taper expansion) on the M/C with BT double face contact spindle. The NIKKEN **2LOCK** tooling can be used as the double face contact on the M/C with BT double face contact spindle.

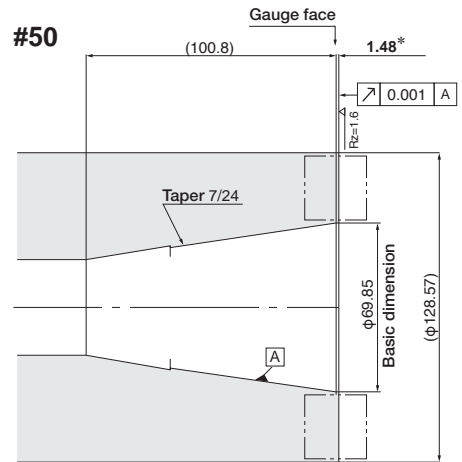
#30



#40

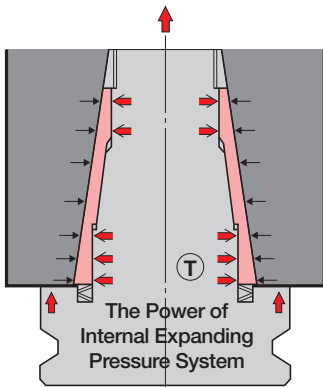


#50



* mark: The tolerances of the extension of the spindle flange from gauge face depend on the M/C.

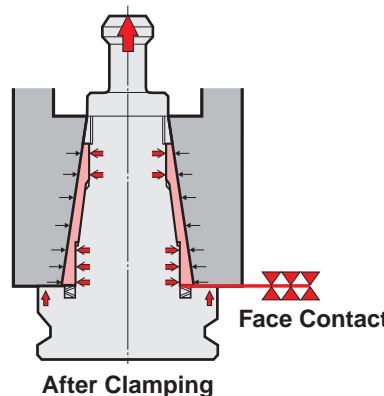
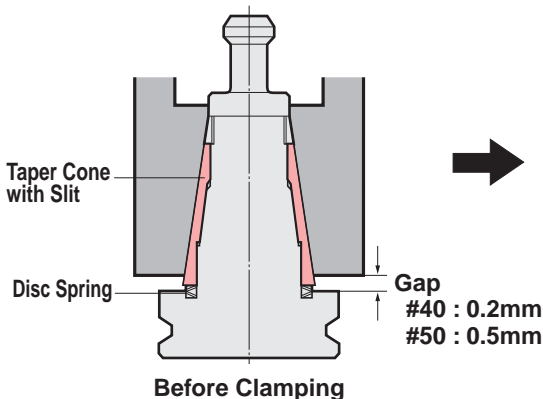
3LOCK TECHNICAL INFORMATION



1. When **3LOCK** tool is inserted into **3LOCK** spindle (before clamping), the gap between the spindle flange and the tool flange is ; #40 : 0.2mm, #50 : 0.5mm
2. When the tool is clamped, the taper cone pre-loaded by the disc springs deforms radially and slides to reach the face contact between the spindle flange and the tool flange.

Deep Profiling Tool for Die Mould

Strong track record even for plunge cutting cutters with a long expanded length



3LOCK MBT MULTI LOCK MILLING CHUCK

NIKKEN

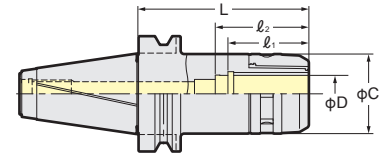
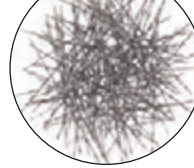


C
Centre Through
MAX. 7MPa

The cutting chips show us the actual machining capability.

Quiet,
high speed, heavy milling

Stable finishing



Standard

3LOCK tooling (MBT) can be used as the triple contact tooling on the M/C where spindle is BT double face contact system.

PAT.

TAPER	Code No.	D	C	L	l ₁	l ₂	Weight (kg)	Collet
No.40	MBT40-C12- 90,120	12	33	90, 120	48	58	1.6, 1.9	(KM12 CCK12)
	-C16- 60, 90,120	16	44	63, 90, 120	50	65	1.4, 1.7, 2.0	(KM16 CCK16)
	-C20- 70, 90,120	20	52	71, 90, 120	57	80	1.6, 1.8, 2.2	(KM20 CCK20 CCNK20)
	-C25- 70, 90,120	25	60	70, 90, 120	60		1.8, 2.1, 2.5	(KM25 CCK25 CCNK25)
	-C32- 85*,105,120	32	69	85, 105, 120	64,70,70	75,81,81	2.1, 2.5, 2.8	(KM32 CCK32 CCNK32)
No.50	MBT50-C12-105,165	12	33	105, 165	48	58	4.0, 4.6	(KM12 CCK12)
	-C16-105,165,200	16	44	105, 165, 200	50	65	4.2, 4.8, 5.1	(KM16 CCK16)
	-C20-105,165,200	20	52		57	80	4.5, 5.1, 5.7	(KM20 CCK20 CCNK20)
	-C25-105,135,165	25	60	105, 135, 165	60		4.8, 5.2, 5.6	(KM25 CCK25 CCNK25)
	-C32- 90,105,120,135,165 -200,250,300	32	69	90,105,120,135,165 200,250,300	70	81	4.3,4.6,5.1,5.6,6.4 7.8,9.2,10.6	(KM32 CCK32 CCNK32)
	-C42- 95*,120,135,165 -200,250,300	42	86	95,120,135,165 200,250,300	73	85,110,125,125 125,125,125	5.5,6.6,7.2,8.6 9.5,11.7,14.0	(KM42 CCK42 CCNK42)

*Spanner is available as an option.

C12 (φC=φ30) : 9HC12 C12A (φC=φ33) : 9HC12A C16 : 9HC16
C20 : 9HC22 C25 : 9HC25 C32 : 9HC32 C42 : 9HC42

*Please note the acceptable shank tolerance is h6~7.

*For heavy duty milling, please grip the cutter shank longer than l₁.

*NK and CCNK collet can not be used for the chucks marked *.

*For C32, l₂ dimension longer than standard is available.

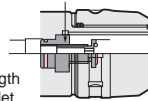
MBT40-C32D- 105 MBT50-C32D- 105

*Centre through tool coolant is available for all models. When the cutter shank length is shorter than l₁, please use the stopper for direct chucking or CCK/CCNK collet.

The Code No. of the Stopper for direct chucking is : C20 : 9MC20, C25 : 9MC25, C32 : 9MC32, C42 : 9MC42



Stopper for
Direct Chucking



*Please refer P.142 for KM and CCK collet.

*Please add "F" for the flange through tool coolant type.

Explanation of the Code No.

MBT40 - C20 - 70

- Nominal Gauge Length
- Chucking Capacity
- Symbol of Milling Chuck
- Shank No.

3LOCK MBT HIGH SPEED MILLING CHUCK

NIKKEN

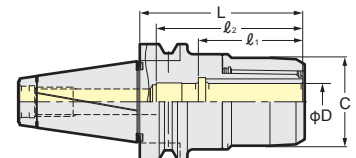


C-G
Centre Through
MAX. 7MPa

ANNIVERSARY Type

— Powerful gripping torque —

- High rigidity
- High precision
- Compact design



High Speed

3LOCK tooling (MBT) can be used as the triple contact tooling on the M/C where spindle is BT double face contact system.

PAT.

TAPER	Code No.	D	C	L	l ₁	l ₂	Weight (kg)	MAX. (min ⁻¹)	Collet
No.40	MBT40-C12- 90G	12	33	90	48	58	1.6	25,000	(KM12 CCK12)
	-C16- 60G, 90G	16	40	63, 90	50	65	1.4, 1.7		(KM16 CCK16)
	-C20- 70G, 90G	20	48	71, 90	57	80	1.6, 1.8	(KM20 CCK20 CCNK20)	
	-C25- 70G, 90G,120G	25	55	70,90,120	60		1.8, 2.1, 2.5	(KM25 CCK25 CCNK25)	
	-C32- 85G*,105G	32	68	85, 105	64,70	75,81	2.1, 2.5	(KM32 CCK32 CCNK32)	
No.50	MBT50-C12-105G	12	33	105	48	58	4.0	20,000	(KM12 CCK12)
	-C16-105G	16	40		50	65	4.2		(KM16 CCK16)
	-C20-105G	20	48		57	80	4.5	(KM20 CCK20 CCNK20)	
	-C25-105G	25	55	60	4.8		(KM25 CCK25 CCNK25)		
	-C32- 90G,105G,120G	32	68	90,105,120	70	81	4.3,4.6,5.1	15,000	(KM32 CCK32 CCNK32)
	-C42- 95P*,120P	42	86	95,120	73	85,110	5.5,6.6	12,000	(KM42 CCK42 CCNK42)

*Please note the acceptable shank tolerance is h6.

*Please refer P.30 for KM and CCK collet.

*GH Handle is available as an option. P.31

C12G : GH12, C16G : GH16, C20G : GH20, C25G : GH25, C32G : GH32

*Spanner for C42P is 9HC42.

*NK and CCNK collet can not be used for the chucks marked *.

*Centre through tool coolant is available for all models. When the cutter shank length is shorter than l₁, please use the stopper for direct chucking or CCK/CCNK collet.

The Code No. of the Stopper for direct chucking is : C20 : 9MC20, C25 : 9MC25, C32 : 9MC32, C42 : 9MC42



Explanation of the Code No.

MBT40 - C20 - 70 G

- Symbol of High Speed
- Nominal Gauge Length
- Chucking Capacity
- Symbol of Milling Chuck
- Shank No.

CENTRE COOLANT STRAIGHT COLLET

PAT.



The Jet Coolant Pressure creates a tornado effect, ensuring efficient swarf dispersal.



CCK

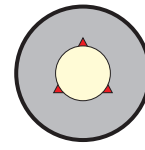
Suitable for all models of the NIKKEN MILLING CHUCK



CCK Collet

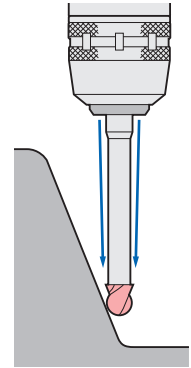


Front Nut



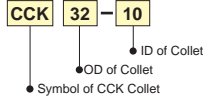
Jet Coolant

Prevention of Swarf entering the collet through the slots

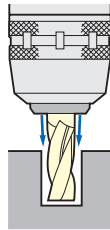


A front nut with an O-ring seal, for use with oil hole cutter, is also available as option.

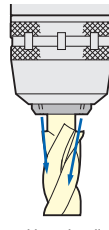
Explanation of the Code No.



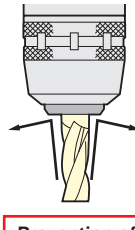
- CCK : Centre Coolant
- CCNK : Centre Coolant, Adjustable
- KM : Standard
- NK : Adjustable
- ONK : Oil Hole Drill
- OJK-A : Jet Coolant
- OJK-S : Multiple Nozzles



For grooving.



For cutters with cutting diameter which is larger than the shank diameter.



Prevention of the swarf contamination.



CKFN-MN



CKFN-C

CCK Collet CKFN front nut and CCKL spanner are available as an option.



Photo shows with front nut.

CCK

Style	CCK Collet Code No. (OD-ID)	Front Nut Code No.
CCK12	CCK12-3, 4, 5, 6, 8, 10	CKFN12
CCK16	CCK16-3, 4, 5, 6, 8, 10, 12	CKFN16
CCK20	CCK20-6, 8, 10, 12, 16	CKFN20
CCK25	CCK25-6, 8, 10, 12, 16, 20	CKFN25
CCK32	CCK32-6, 8, 10, 12, 16, 20, 25	CKFN32, CKFN32T
CCK42	CCK42-6, 8, 10, 12, 16, 20, 25, 32	CKFN42

- ★Above bold figures indicate "ANNIVERSARY" type CCK Collet.
- ★Please note the acceptable shank tolerance is h_6-h_7 .
- ★Other metric sizes and imperial sizes, 1/8, 1/4, 5/16, 3/8, 7/16, 1/2, 5/8, 3/4, 13/16, 7/8, 1, 1-1/8, 1-1/4, 1-1/2" are also available.



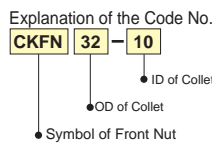
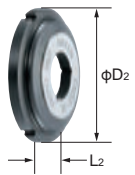
Photo shows with front nut.

CCNK

Style	CCK Collet Code No. (OD-ID)	Front Nut Code No.
CCNK20	CCNK20-6, 8, 10, 12, 16	CKFN20
CCNK25	CCNK25-6, 8, 10, 12, 16, 20	CKFN25
CCNK32	CCNK32-6, 8, 10, 12, 16, 20, 25	CKFN32, CKFN32T
CCNK42	CCNK42-6, 8, 10, 12, 16, 20, 25, 32	CKFN42

- ★Please note the acceptable shank tolerance is h_6-h_7 .
- ★Other metric sizes and imperial sizes, 1/8, 1/4, 5/16, 3/8, 7/16, 1/2, 5/8, 3/4, 13/16, 7/8, 1, 1-1/8, 1-1/4, 1-1/2" are also available.

Front Nut CKFN



Style	ϕD_2	L_2	Front Nut Code No.
CKFN12	19.5	7	CKFN12 -3, 4, 5, 6, 8, 10
CKFN16	28.5	8	CKFN16 -3, 4, 5, 6, 8, 10, 12
CKFN20	33	8	CKFN20 -6, 8, 10, 12, 16
CKFN25	39	8.5	CKFN25 -6, 8, 10, 12, 16, 20
CKFN32	46.5	9	CKFN32 -6, 8, 10, 12, 16, 20, 25
CKFN32T	43	9	CKFN32T -6, 8, 10, 12, 16, 20, 25
CKFN42	59.5	9	CKFN42 -6, 8, 10, 12, 16, 20, 25, 32



★The front nut for direct chucking is also available. e.g. CKFN20-20D, CKFN25-25D, CKFN32-32D

★The Code No. fitted with O-ring is ; e.g. CKFN20-20DC, CKFN25-25DC, CKFN32-32DC

- ★For C32 there are 2 sizes, CKFN32 = for nose ring diameter of $\phi 69\text{mm}$, CKFN32T = for nose ring diameter of $\phi 64\text{mm}$.
- ★Jet Coolant type for the cutter with a cutter dia. larger than shank dia. is also available. CKFN25-20MN, CKFN32-25MN, CKFN42-32M
- ★Front Nut fitted with an O-ring is also available. e.g. The Code No. is CKFN32-10C
- ★The spanner is available as an option. CKFN12 : CCKL12, CKFN16 : CCKL16 CKFN20 : CCKL20 CKFN25, CKFN32T : CCKL25 CKFN32 : CCKL32, CKFN42 : CCKL42

Style KM Collet Code No. (OD-ID)



Photo shows ANNIVERSARY type KM Collet.

Cutter length adjustment on the collet is possible from front and back.



NK

Style	KM Collet Code No. (OD-ID)
KM12	KM12-2, 3, 4, 5, 6, 7, 8, 9, 10
KM16	KM16-2, 3, 4, 5, 6, 7, 8, 9, 10, 11, 12
KM20	KM20-2, 3, 4, 5, 6, 7, 8, 9, 10, 11, 12, 13, 14, 15, 16
KM25	KM25-3, 4, 5, 6, 7, 8, 9, 10, 11, 12, 13, 14, 15, 16, 17, 18, 19, 20, 21, 22
KM32	KM32-3, 4, 5, 6, 7, 8, 9, 10, 11, 12, 13, 14, 15, 16, 17, 18, 19, 20, 21, 22, 23, 24, 25, 26, 30
KM42	KM42-3, 4, 5, 6, 7, 8, 9, 10, 11, 12, 13, 14, 15, 16, 17, 18, 19, 20, 21, 22, 23, 24, 25, 26, 27, 28, 29, 30, 31, 32, 40

- ★[For Synchronous Tapping Program] : Special ID Collets for Tap Shank are also available.
- ★Other metric sizes and imperial sizes, 1/8, 1/4, 5/16, 3/8, 7/16, 1/2, 5/8, 3/4, 13/16, 7/8, 1, 1-1/8, 1-1/4, 1-1/2" are also available.
- ★The collets with bold character are the "ANNIVERSARY" type KM Collet.
- ★Ordinary KM Collet can be used with "ANNIVERSARY" type Milling Chuck , but better performance can be found with the "ANNIVERSARY" type KM Collet.
- ★Please note the acceptable shank tolerance is h_6-h_7 .

Style	NK Collet Code No. (OD-ID)
NK20	NK20-3, 4, 5, 6, 7, 8, 9, 10, 11, 12, 13, 14, 15, 16
NK22	NK22-3, 4, 5, 6, 7, 8, 9, 10, 11, 12, 13, 14, 15, 16, 17, 18
NK25	NK25-3, 4, 5, 6, 7, 8, 9, 10, 11, 12, 13, 14, 15, 16, 17, 18, 19, 20, 21, 22
NK32	NK32-3, 4, 5, 6, 7, 8, 9, 10, 11, 12, 13, 14, 15, 16, 17, 18, 19, 20, 21, 22, 23, 24, 25, 26
NK42	NK42-3, 4, 5, 6, 7, 8, 9, 10, 11, 12, 13, 14, 15, 16, 17, 18, 19, 20, 21, 22, 23, 24, 25, 26, 27, 28, 29, 30, 31, 32

- ★[For Synchronous Tapping Program] : Special ID Collets for Tap Shank are also available.
- ★Other metric sizes and imperial sizes, 1/8, 1/4, 5/16, 3/8, 7/16, 1/2, 5/8, 3/4, 13/16, 7/8, 1, 1-1/8, 1-1/4, 1-1/2" are also available.
- ★The collets with bold character are standard.
- ★Please note the acceptable shank tolerance is h_6-h_7 .
- ★Collet removal (9CKR) is available as an option.
- ★Please refer P.31, P.32 for more detail of the straight collet.



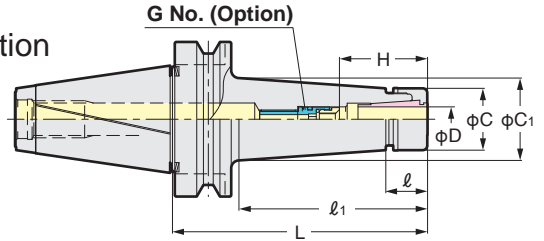
3LOCK MBT SLIM CHUCK

NIKKEN



NEW

SKT13, SKT20 Series Addition



SKT
Centre Through
MAX. 7MPa

Standard 3LOCK tooling (MBT) can be used as the triple contact tooling on the M/C where spindle is BT double face contact system.

When SK J type nut is used, the total chuck length will be extended by 6mm.

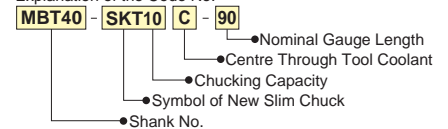
TAPER	Code No.	D	L	ℓ	ℓ ₁	C	C ₁	H	G No. (Option)	Weight (kg)	SK Collet
No.40	MBT40-SKT 6C- 90	0.7~6.0	90	19.8	60	19.5	25.2	26~31	SKG 6- 6HG	1.1	SK 6
	-120		120		90		29.4			1.4	
	-SKT10C- 90	1.75~10.0	90	22	60	27.5	32.9	35~41	SKG10-10HG	1.2	SK10
	-120		120		90		37.1			1.4	
	-150		150		120		41.3			1.6	
	-SKT13C- 90	2.75~13.0	90	26	60	33	37.8	39~51	SKG13-10HG	1.4	SK13
	-120		120		90		42.0			1.6	
	-150		150		120		46.2			1.8	
	-SKT16C- 90	2.75~16.0	90	27	60	40	44.7	45~57	SKG16-12HG	1.5	SK16
	-120		120		90		48.9			1.7	
	-150		150		120		53.1			1.9	
	-SKT20C- 90	3.5~20.0	90	28.5	60	48.5	53.0	47~63	SKG20-18HG	1.6	SK20
	-120		120		92		57.4			2.0	
	-SKT25C- 90	7.5~25.4	90	31	62.6	55	59.5	60~65	SKG25-18HGD	1.8	SK25
-120	120		92.2		59.3		2.4				
No.50	MBT50-SKT 6C-105	0.7~6.0	105	19.8	62	19.5	25.5	26~31	SKG 6- 6HG	3.8	SK 6
	-165		165		122		33.8			4.0	
	-SKT10C-105	1.75~10.0	105	22	62	27.5	33.1	35~41	SKG10-10HG	4.2	SK10
	-165		165		122		41.5			4.6	
	-SKT13C-105	2.75~13.0	105	26	62	33	38.1	39~51	SKG13-10HG	4.5	SK13
	-165		165		122		46.5			4.9	
	-SKT16C-105	2.75~16.0	105	27	62	40	44.9	45~57	SKG16-12HG	4.7	SK16
	-165		165		122		53.3			5.1	
	-SKT20C-105	3.5~20.0	105	28.5	62	48.5	53.2	47~63	SKG20-18HG	4.3	SK20
	-165		165		122		61.6			5.0	
	-SKT25C-105	7.5~25.4	105	31	62	55	59.4	60~70	SKG25-24HG	5.2	SK25
	-165		165		122		67.8			5.6	

★ Collet, adjust screw (G No.) and GH Handle are available as an option.
The Code No. of the GH Handle is SKT6C-P: GH6, SKT10C-P: GH10, SKT13C-P: GH13, SKT16C-P: GH16, SKT20C-P: GH20, SKT25C-P: GH25

★ Please use P class collet or A type collet. ☞ P.145
★ All models are high pressure centre through tool coolant type.
SKT6: φ4~φ6, SKT10: φ6~φ10, SKT13: φ10~φ16, SKT20: φ6~φ20, SKT25: φ16~φ25
★ Please refer ☞ P.43, P.44 for the adjust screw (G No.)



Explanation of the Code No.



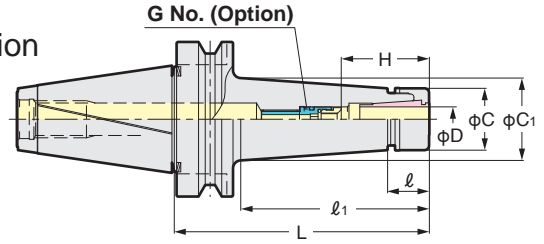
3LOCK MBT HIGH SPEED SLIM CHUCK

NIKKEN



NEW

SKT13, SKT20 Series Addition



SKT-P

Centre Through
MAX. 7MPa

High Speed **3LOCK** tooling (MBT) can be used as the triple contact tooling on the M/C where spindle is BT double face contact system.
When SK J type nut is used, the total chuck length will be extended by 6mm.

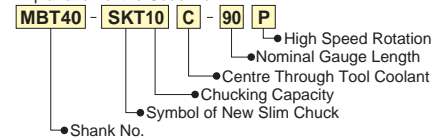
TAPER	Code No.	D	L	ℓ	ℓ ₁	C	C ₁	H	G No. (Option)	Weight (kg)	SK Collet
No.40	MBT40-SKT 6C- 90P	0.7~6.0	90	19.8	60	19.5	25.2	26~31	SKG 6- 6HG	1.1	SK 6
	-120P		120		90		29.4			1.4	
	-SKT10C- 90P	1.75~10.0	90	22	60	27.5	32.9	35~41	SKG10-10HG	1.2	SK10
	-120P		120		90		37.1			1.4	
	-150P		150		120		41.3			1.6	
	-SKT13C- 90P	2.75~13.0	90	26	60	33	37.8	39~51	SKG13-10HG	1.4	SK13
	-120P		120		90		42.0			1.6	
	-150P		150		120		46.2			1.8	
	-SKT16C- 90P		90		27		60			40	
	-120P	120	90	48.9		1.7					
	-150P	150	120	53.1		1.9					
	-SKT20C- 90P	3.5~20.0	90	28.5	60	48.5	53.0	47~63	SKG20-18HG	1.6	SK20
	-120P		120		92		57.4			2.0	
	-SKT25C- 90P	7.5~25.4	90	31	62.6	55	59.5	60~65	SKG25-18HGD	1.8	SK25
-120P	120		92.2		59.3		2.4				
No.50	MBT50-SKT 6C-105P	0.7~6.0	105	19.8	62	19.5	25.5	26~31	SKG 6- 6HG	3.8	SK 6
	-165P		165		122		33.8			4.0	
	-SKT10C-105P	1.75~10.0	105	22	62	27.5	33.1	35~41	SKG10-10HG	4.2	SK10
	-165P		165		122		41.5			4.6	
	-SKT13C-105P	2.75~13.0	105	26	62	33	38.1	39~51	SKG13-10HG	4.5	SK13
	-165P		165		122		46.5			4.9	
	-SKT16C-105P	2.75~16.0	105	27	62	40	44.9	45~57	SKG16-12HG	4.7	SK16
	-165P		165		122		53.3			5.1	
	-SKT20C-105P	3.5~20.0	105	28.5	62	48.5	53.2	47~63	SKG20-18HG	4.3	SK20
	-165P		165		122		61.6			5.0	
	-SKT25C-105P	7.5~25.4	105	31	62	55	59.4	60~70	SKG25-24HG	5.2	SK25
	-165P		165		122		67.8			5.6	

★ Collet, adjust screw (G No.) and GH Handle are available as an option.
The Code No. of the GH Handle is SKT6C-P: GH6, SKT10C-P: GH10, SKT13C-P: GH13, SKT16C-P: GH16, SKT20C-P: GH20, SKT25C-P: GH25

★ Please use P class collet or A type collet. ☞ P.145
★ All models are high pressure centre through tool coolant type.
SKT6: φ4~φ6, SKT10: φ6~φ10, SKT16: φ10~φ16, SKT20: φ6~φ20, SKT25: φ16~φ25
★ Please refer ☞ P.43, P.44 for the adjust screw (G No.)

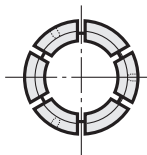
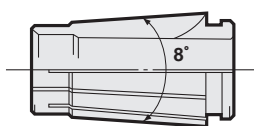


Explanation of the Code No.

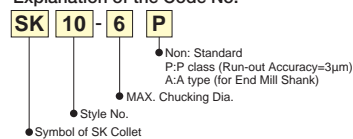


3LOCK

SLIM CHUCK COLLET



Explanation of the Code No.



SK “A” type SK collet (for End Mill Shank) are marked **A**. The acceptable shank tolerance is h8. Code No. is e.g. SK10-10A
 “P” class SK collet (for drill) are available for all series. e.g. SK10-10P

Code No.	Chucking D
SK 6- 0.8	0.7 ~ 0.8
- 1	0.9 ~ 1.0
- 1.25	1.15~ 1.25
- 1.5	1.3 ~ 1.5
- 1.75	1.55~ 1.75
- 2	1.8 ~ 2.0
- 2.25	2.05~ 2.25
- 2.5	2.3 ~ 2.5
- 2.75	2.55~ 2.75
- 3	2.8 ~ 3.0
- 3.5	3.0 ~ 3.5
- 4	3.5 ~ 4.0
- 4.5	4.0 ~ 4.5
- 5	4.5 ~ 5.0
- 5.5	5.0 ~ 5.5
- 6	5.5 ~ 6.0
SK10- 2	1.75~ 2.0
- 2.25	2.0 ~ 2.25
- 2.5	2.25~ 2.5
- 2.75	2.5 ~ 2.75
- 3	2.75~ 3.0
- 3.5	3.0 ~ 3.5
- 4	3.5 ~ 4.0
- 4.5	4.0 ~ 4.5
- 5	4.5 ~ 5.0
- 5.5	5.0 ~ 5.5
- 6	5.5 ~ 6.0
- 6.5	6.0 ~ 6.5
- 7	6.5 ~ 7.0
- 7.5	7.0 ~ 7.5
- 8	7.5 ~ 8.0
- 8.5	8.0 ~ 8.5
- 9	8.5 ~ 9.0
- 9.5	9.0 ~ 9.5
-10	9.5 ~10.0

Code No.	Chucking D
SK13- 3	2.75~ 3.0
- 3.5	3.0 ~ 3.5
- 4	3.5 ~ 4.0
- 4.5	4.0 ~ 4.5
- 5	4.5 ~ 5.0
- 5.5	5.0 ~ 5.5
- 6	5.5 ~ 6.0
- 6.5	6.0 ~ 6.5
- 7	6.5 ~ 7.0
- 7.5	7.0 ~ 7.5
- 8	7.5 ~ 8.0
- 8.5	8.0 ~ 8.5
- 9	8.5 ~ 9.0
- 9.5	9.0 ~ 9.5
- 10	9.5 ~10.0
- 10.5	10.0~10.5
- 11	10.5~11.0
- 11.5	11.0~11.5
- 12	11.5~12.0
- 12.5	12.0~12.5
- 13	12.5~13.0

Code No.	Chucking D
SK16- 3	2.75~ 3.0
- 3.5	3.0 ~ 3.5
- 4	3.5 ~ 4.0
- 4.5	4.0 ~ 4.5
- 5	4.5 ~ 5.0
- 5.5	5.0 ~ 5.5
- 6	5.5 ~ 6.0
- 6.5	6.0 ~ 6.5
- 7	6.5 ~ 7.0
- 7.5	7.0 ~ 7.5
- 8	7.5 ~ 8.0
- 8.5	8.0 ~ 8.5
- 9	8.5 ~ 9.0
- 9.5	9.0 ~ 9.5
- 10	9.5 ~10.0
- 10.5	10.0~10.5
- 11	10.5~11.0
- 11.5	11.0~11.5
- 12	11.5~12.0
- 12.5	12.0~12.5
- 13	12.5~13.0
- 13.5	13.0~13.5
- 14	13.5~14.0
- 14.5	14.0~14.5
- 15	14.5~15.0
- 15.5	15.0~15.5
- 16	15.5~16.0

Code No.	Chucking D
SK20- 4	3.5 ~ 4.0
- 4.5	4.0 ~ 4.5
- 5	4.5 ~ 5.0
- 5.5	5.0 ~ 5.5
- 6	5.5 ~ 6.0
- 6.5	6.0 ~ 6.5
- 7	6.5 ~ 7.0
- 7.5	7.0 ~ 7.5
- 8	7.5 ~ 8.0
- 8.5	8.0 ~ 8.5
- 9	8.5 ~ 9.0
- 9.5	9.0 ~ 9.5
- 10	9.5 ~ 10.0
- 10.5	10.0~ 10.5
- 11	10.5~ 11.0
- 11.5	11.0~ 11.5
- 12	11.5~ 12.0
- 12.5	12.0~ 12.5
- 13	12.5~ 13.0
- 13.5	13.0~ 13.5
- 14	13.5~ 14.0
- 14.5	14.0~ 14.5
- 15	14.5~ 15.0
- 15.5	15.0~ 15.5
- 16	15.5~ 16.0
- 16.5	16.0~ 16.5
- 17	16.5~ 17.0
- 17.5	17.0~ 17.5
- 18	17.5~ 18.0
- 18.5	18.0~ 18.5
- 19	18.5~ 19.0
- 19.5	19.0~ 19.5
- 20	19.5~ 20.0

Code No.	Chucking D
SK25- 8	7.5~8.0
- 10	9.5~10.0
- 12	11.5~12.0
- 16	15.5~16.0
- 16.5	16.0~16.5
- 17	16.5~17.0
- 17.5	17.0~17.5
- 18	17.5~18.0
- 18.5	18.0~18.5
- 19	18.5~19.0
- 19.5	19.0~19.5
- 20	19.5~20.0
- 20.5	20.0~20.5
- 21	20.5~21.0
- 21.5	21.0~21.5
- 22	21.5~22.0
- 22.5	22.0~22.5
- 23	22.5~23.0
- 23.5	23.0~23.5
- 24	23.5~24.0
- 24.5	24.0~24.5
- 25	24.5~25.0
- 25.4	25.0~25.4

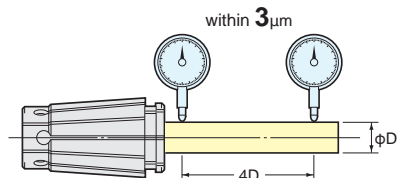
★SK6 collet with the special internal dia. is also available.



Collet removal (SKR-6) is supplied as standard only for SK6. SKR-10, SKR-16 and SKR-25 are available as an option. Collet removal is not necessary for the new types of collet (SK10 to SK25 collet including SK13 and SK20).

“P” class SK collet for drill

It guarantees the Run-out accuracy within 3 micron at the nose (4D) from the chuck. Additionally Collet Set is also available.



“A” type SK collet for endmill

The acceptable shank tolerance is h8.

SK Collet A type
SK 6-3A, 3.175A, 4A, 5A, 6A
SK10-3A, 3.175A, 4A, 5A, 6A, 8A, 10A
SK13-3A, 4A, 5A, 6A, 8A, 10A, 12A
SK16-3A, 4A, 5A, 6A, 8A, 10A, 12A, 16A
SK20-4A, 5A, 6A, 8A, 10A, 12A, 16A, 20A
SK25-8A, 10A, 12A, 16A, 20A, 25A

3LOCK MBT MINI-MINI CHUCK

The best chuck for the small dia. cutting tool

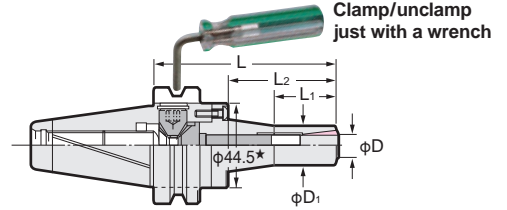


JAPAN PAT.



MMC

30,000min⁻¹ & G2.5
Gripping from Front Nose
Run-Out Accuracy : 3µm at 4D



★ MMC12 : φ52.4

High Speed

3LOCK tooling (MBT) can be used as the triple contact tooling on the M/C where spindle is BT double face contact system.

PAT.

TAPER	Code No.	Chucking Range φD	φD ₁	L	L ₁	L ₂	Collet	MAX. (min ⁻¹)	Weight (kg)
No.40	MBT40-MMC 4- 90	1~ 4	15	90	30	43	MPK 4	30,000	1.2
	-MMC 8- 90	2~ 8	20		36	42	PMK 8 VMK 8		1.4
	-120			43	72	PMK12 VMK12	1.5		
	-MMC12- 90	4~12	30	90	35		44		1.7
	-120			120	60		74		1.8
No.50	MBT50-MMC 4-105	1~ 4	15	105	30	43	MPK 4	20,000	3.8
	-MMC 8-105	2~ 8	20		36	42	PMK 8 VMK 8		4.4
	-135			135	43	72			4.5
	-165	165	102	4.6					
	-MMC12-105	4~12	30	105	35	44	PMK12 VMK12		4.6
	-135			135	60	74			4.7
	-165	165	70	104	4.8				

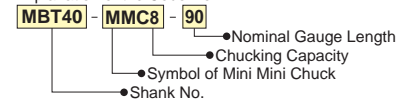
★Wrench is supplied as standard.

★MPK, PMK, VMK collet is available as an option. Please refer P.32

★Please add "C" for the centre through tool coolant type. e.g. MBT40-MMC8C-90

★Please add "F" for the flange through tool coolant type; MBT40-MMC 8F- 90,120 MBT50-MMC 8F-105,120
-MMC12F- 90,120 -MMC12F-105,120

Explanation of the Code No.

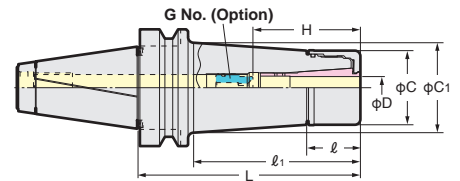


3LOCK MBT VC HOLDER



VC

Centre Through
MAX. 7MPa



High Speed

3LOCK tooling (MBT) can be used as the triple contact tooling on the M/C where spindle is BT double face contact system.

PAT.

TAPER	Code No.	D	L	l	l ₁	C	C ₁	H	G No. (Option)	Weight (kg)	MAX. (min ⁻¹)	Collet
No.40	MBT40-VC 6- 60	2.0~6.0	60	23	30	27.5	30.0	35~45	VCG 6- 8A	1.1	30,000	VCK 6
	- 90		90		60		32.7			1.3		
	-120		120		90		36.9			1.5		
	-VC13- 60	3.0~12.0	60	31	40.3	1.2	VCG13-15A					
	- 90		90	40	44.3	1.5						
-120	120	90	48.5	1.9								
No.50	MBT50-VC 6-105	2.0~6.0	105	23	62	27.5	33.0	35~45	VCG 6- 8A	3.9	20,000	VCK 6
	-135		135		92		37.1			4.1		
	-165		165		122		41.3			4.4		
	-VC13-105	3.0~12.0	105	62	44.6	4.1	VCG13-15A					
	-135		135	92	48.8	4.5						
	-165	165	122	53.0	4.9							

★Collet, adjust screw (G No.) and GH Handle are available as an option. The Code No. of the GH Handle is VC6: GH10, VC13: GH16

★When the axial stopper is required, please use Adjust Screw (G No.)

★MBT40-VC 6-150, MBT40-VC13-150, MBT50-VC13- 90, -120 are available as semi-standard.

★TiN Bearing Nut is supplied as standard.

★Please add "RP" at the end of Code No. for Rust Proof Treatment VC Holder. e.g. MBT40-VC13-60-RP

★Please use VC J type Nut & Cap for Centre Through Coolant.

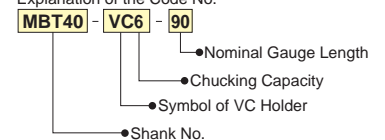
When VC J type Nut is used, the total holder length will be extended to 6mm.

★Please refer P.34 for VCK collet.



Please refer P.30

Explanation of the Code No.

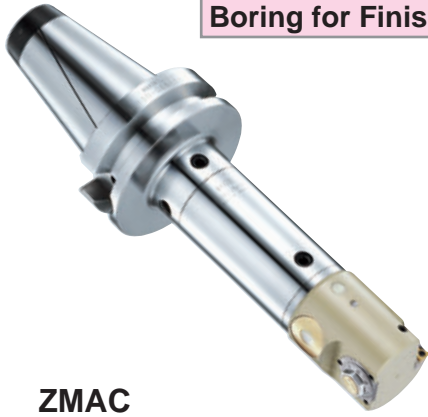


3LOCK

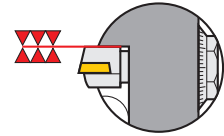
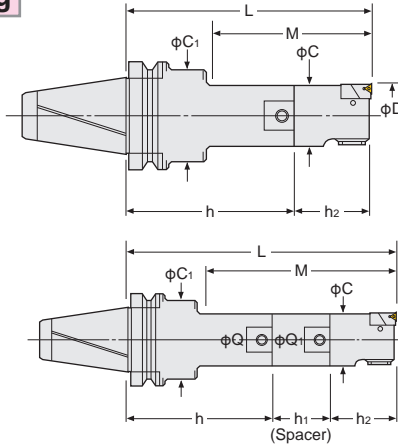
3BLOCK ZMAC BORING ARBOR



Boring for Finishing

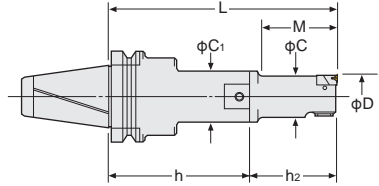


ZMAC
Photo shows ZMAC \times .



No Micro Vibration due to Double-Contact Support of Cartridge. Long Tool-Life & High Accuracy.

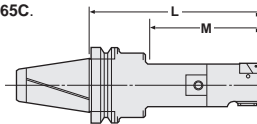
Only for ZMAC16



All codes shown are for heads with triangular inserts For heads with rhomboid inserts please add the letter "R" to the code No. e.g. MBT40-ZMAC32 R -150

TAPER	Code No. MBTNo.- Min.D - L	Boring Range D	Boring Depth M	Coupling Dia M	C	C1	P.98		Weight (kg)
							Head No. Q- Min.D -h2	Insert No.	
No.40	MBT40-ZMAC 16-125, 135	15.9~20.2	38, 48	12	15	24	12-ZMAC16-45, 55	3MP-C,B	1.9, 1.9
	-ZMAC 20-120, 135, 150	19.8~25.2	45, 67, 75	9	19	30	9-ZMAC20-40		1.9, 1.9, 2.0
	-ZMAC 25-120, 150, 165	24.8~32.2	52, 90, 97	12	24	35	12-ZMAC25-40		2.0, 2.1, 2.1
	-ZMAC 32-150, 180, 195	31.8~42.2	77, 110, 122	16	31	42	16-ZMAC32-55	4MP-C,B	2.5, 2.7, 2.7
	-ZMAC 42-150, 180, 210	41.8~55.2	97, 130, 157	20	40	50	20-ZMAC42-70	6MP-C,B	3.0, 3.2, 3.5
	-ZMAC 55-165, 210, 225	54.8~70.2	135, 180, 195	26	53	50	26-ZMAC55-70		3.9, 4.6, 4.6
	-ZMAC 70-165, 180, 225	69.8~85.2	165, 180, 225	34	67	64	34-ZMAC70-70		5.4, 5.8, 6.8
-ZMAC 85-195	84.8~100.2	195	42	83	62	42-ZMAC85-100	9.0		
No.50	MBT50-ZMAC 16-140, 150	15.9~20.2	38, 48	12	15	24	12-ZMAC16-45, 55	3MP-C,B	4.7, 4.7
	-ZMAC 20-150, 165, 180	19.8~25.2	45, 67, 75	9	19	40	9-ZMAC20-40		4.8, 4.8, 4.9
	-ZMAC 25-135, 165, 180	24.8~32.2	52, 90, 97	12	24	44	12-ZMAC25-40		4.8, 4.8, 4.9
	-ZMAC 32-180, 210, 225	31.8~42.2	77, 110, 122	16	31	50	16-ZMAC32-55	4MP-C,B	5.5, 5.6, 5.7
	-ZMAC 42-180, 195, 225, 240	41.8~55.2	97, 130, 142, 157	20	40	60	20-ZMAC42-70	6MP-C,B	6.0, 6.0, 6.4, 6.5
	-ZMAC 55-210, 240, 270	54.8~70.2	117, 182, 177	26	53	65	26-ZMAC55-70		7.5, 7.6, 8.1
	-ZMAC 70-240, 270, 300	69.8~85.2	190, 220, 250	34	67	80	34-ZMAC70-70		10.0, 10.6, 11.5
	-ZMAC 85-225, 290, 315	84.8~100.2	182, 247, 272	42	83	83	42-ZMAC85-100		12.5, 15.0, 16.0
	-ZMAC100-225, 290*	99.5~140.5	225, 290				42-ZMAC100-100		13.8, 16.5
-ZMAC140-225, 290*	139.5~180.5	42-ZMAC140-100					14.6, 17.3		

- ★MIN. dial readout : ZMAC25 & smaller is 0.02mm on diameter. ZMAC32 and larger are 0.01mm on diameter.
- ★"C" grade (Coated) insert for Steel, Stainless & Cast Iron is supplied as Standard with the head (Smooth boring & Long tool-life). We would recommend "B" grade (CBN) insert for Hardened Steel & High Speed boring of Cast Iron. Please refer P.96 for cutting condition.
- ★Please refer P.149 for Shank, and P.86 for Spacer, and P.77 for Head.
- ★For Centre Through Tool Coolant type, please add "C" at the end of Code No. e.g. MBT40-ZMAC55-165C.
- ★When L length is required longer than standard, please specify boring depth M.
- ★* : MBT50-ZMAC100-325, 375, 425, 475 are also available.
MBT50-ZMAC140-325, 375, 425, 475



High Pressure Coolant Through Tool

High Speed Boring ZMAC \times
Special Hardened Light Alloy Metal Head with Balancing for Anti-Vibration.
MAX12,000min⁻¹

ZMAC for Multi-Stage Boring Bar

Please contact us for the special boring bar.

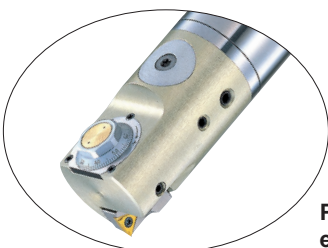
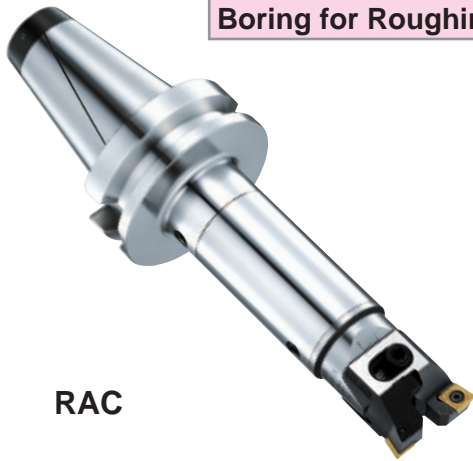


Photo. shows NC5 shank.

Please add "AA" at the end of Code No. for the boring arbor with ZMAC \times head. P.78
e.g. MBT40-ZMAC42-150AA

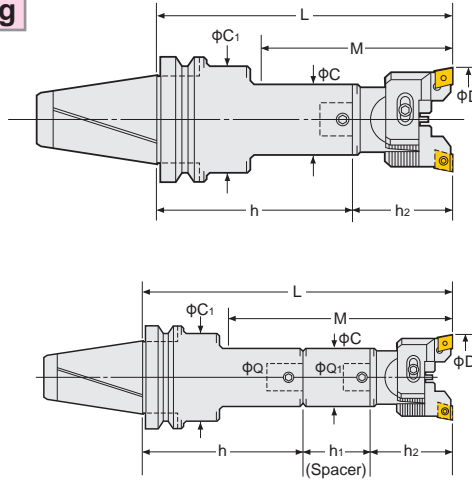
3BLOCK BALANCE-CUT BORING ARBOR

NIKKEN

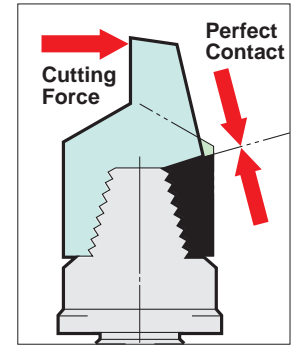


RAC

Boring for Roughing



Power of Shoulder Support

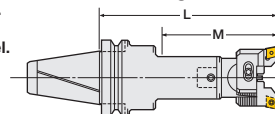


3Block

TAPER	Code No.	Boring Range D	Boring Depth M	Coupling Dia Q	C	C1	P.62		Weight (kg)
							Head No.	Insert No.	
	MBTNo.- Min.D -L						Q- Min.D -h2		
No.40	MBT40-RAC 25-135E, 165E, 180E	25~32	67, 105, 112	12	24	35	12-RAC025- 55E	CC07-C	2.0, 2.1, 2.1
	-RAC 32-150E, 180E, 195E	32~45	77, 110, 122	16	31	42	16-RAC 32- 55E	CC08-C	2.4, 2.6, 2.6
	-RAC 43-150E, 180E, 210E	43~55	97, 130, 157	20	40	50	20-RAC 43- 70E	CC12-C	2.7, 2.9, 3.2
	-RAC 53-165E, 210E, 225E	53~70	135, 180, 195	26	50	50	26-RAC 53- 70E		2.5, 3.3, 3.2
	-RAC 70-180E, 195E, 240E	70~100	180, 195, 240	34	64	64	34-RAC 70- 85E		4.8, 5.2, 6.2
	-RAC100-195E	100~130	195	42	83	62	42-RAC100-100E		6.8
No.50	MBT50-RAC 25-150E, 180E, 195E	25~32	67, 105, 112	12	24	44	12-RAC 25- 55E	CC07-C	4.7, 4.9, 4.8
	-RAC 32-180E, 210E, 225E	32~45	77, 110, 122	16	31	50	16-RAC 32- 55E	CC08-C	5.4, 5.6, 5.6
	-RAC 43-180E, 195E, 225E, 240E	43~55	97, 130, 142, 157	20	40	60	20-RAC 43- 70E	CC12-C	5.7, 5.8, 6.1, 6.2
	-RAC 53-210E, 240E, 270E	53~70	117, 182, 177	26	50	65	26-RAC 53- 70E		6.9, 7.0, 7.6
	-RAC 70-255E, 285E, 315E	70~100	205, 235, 265	34	64	80	34-RAC 70- 85E		9.5, 9.9, 10.9
	-RAC100-225E, 290E, 325E *	100~130	225, 290, 325	42	83	83	42-RAC100-100E		12.5, 12.5, 16.5

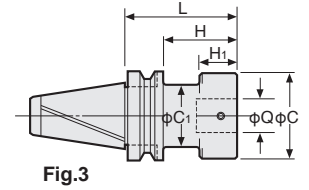
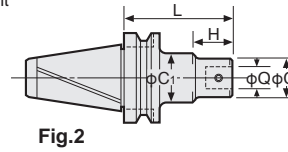
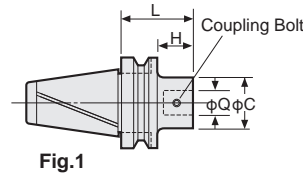
- ★ "C" grade (Coated) inserts are supplied as standard with the head. P.62 Please refer P.93 for cutting condition.
- ★ Please refer P.149 for base holder, P.86 for spacer and P.67 for head.
- ★ For centre through tool coolant type, please add "-C" at the end of Code No. e.g. MBT40-RAC53-165E-C
- ★ Cartridges & Insert tips for the Heavy Duty Boring of Iron and Cast Iron (No letter), for Aluminum (A), and for Through Hole & Multiple Sheets (K) are available. Please refer P.69 for cartridges. Please add the letter "No letter", "A" or "K" at the end of Code No. e.g. MBT40-RAC53-165A
- ★ For MBT30, modular connection system is applied. Please refer P.149 for Base Holder.
- ★ When L length is required longer than standard, please specify the boring depth M.
- ★ Cartridge & Insert for Alloy Steel (E) is recommended for boring on steel and stainless steel.
- ★ * : MBT50-RAC100-375E, 425E and 475E are also available.

Code No. of RAC25 and RAC32 with CC inserts are changed to RAC25E and RAC32E.
Please refer P.61, P.62



High Pressure Coolant Through Tool

3LOCK MODULAR TYPE BORING BASE HOLDER



Q

3LOCK tooling (MBT) can be used as the triple contact tooling on the M/C where spindle is BT double face contact system.

TAPER	Code No.	Coupling φQ	L	C	C ₁	H	H ₁	Coupling Bolt No.	Fig.	Weight (kg)
No. 40	MBT40-Q26- 50,95,140	26	50, 95,140	50	-	20,65,110	-	B26N	1	1.1, 1.7, 2.5
	(MIT40)-Q34- 95,110	34	95,110	64	62	68,83	55,70	B34	3	2.2, 2.6
	-Q42- 95	42	95	83	62	68	55	B42		2.8
No. 50	MBT50-Q26- 65,140,170N	26	65,140,170	50	65	27,47,112	-	B26N	1,2,2	3.7, 5.3, 5.4
	(MIT50)-Q34-140,170,200	34	140,170,200	64	80	102,120,150	-	B34		5.6, 6.5, 7.1
	-Q42-125,190	42	125,190	83	-	87,152	-	B42	1	6.5, 9.1

★φC of Q26 base holder has been increased from 45mm to 50mm due to improvement of its rigidity.

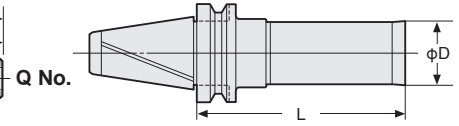
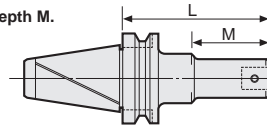
★All base holders have a centre through-tool coolant hole.

★The Coupling screw & wrench are supplied as standard.

★When L length is required longer than standard, please specify the boring depth M.

★MBT50-Q42-225A, 275A, 325A and 375A are the arbor with tapered shape.

★Blank arbor with **3LOCK** shank is available.
MIN. order quantity of blank arbor is 5 off.



Please specify ;

· Hardness of arbor : Raw or HRC40±2

· φD×L

e.g. φD=50mm, L=200mm MBT50-BLK50-200

3LOCK DJ BORING HEAD with DJ BORING BIT

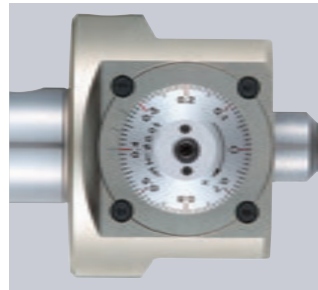


High Pressure Coolant Through type is available Please contact with us.

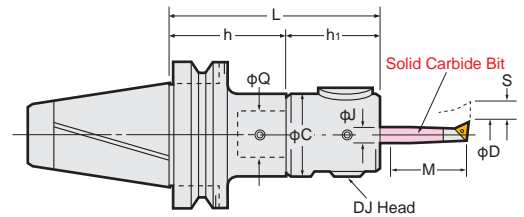
Easy to Set Micron Accuracy



DJ



▲1Graduation:0.01mm on dia.



TAPER	Code No.	Boring Range	Boring Depth	L	C	Bit Hole Size	Shank Code No.	Head Code No.	Bit Stroke	Insert Tip Code No.
	MBTNo.-MinD-L					D				
No. 40	MBT40-DJ3- 86	3~28	14~ 80	86	45	10	MBT40-Q26- 50	Q26-DJ3-36	5.2	J10
	(MIT40) -131			131						
	-DJ8- 94AN	3~50	14~130	94	59	16	MBT40-Q26- 50	-DJ8-44AN	6.0	J16
	-139AN			139						
No. 50	MBT50-DJ3-101	3~28	14~ 80	101	45	10	MBT50-Q26- 65	Q26-DJ3-36	5.2	J10
	(MIT50) -206			206						
	-DJ8-109AN	3~50	14~130	109	59	16	MBT50-Q26- 65	-DJ8-44AN	6.0	J16
	-214AN			214						

★MIN. dial readout on dia.: 0.01mm, Sub scale: 0.005mm, 0.8mm/rev.

★Each boxed set of DJ3 and DJ8 Boring Bars include 4 pcs of DJ Boring Bits as standard.

★Bits included for MBT40-DJ8-94A : J16-8-40, J16-18-80, J16-28-85, J16-38-85

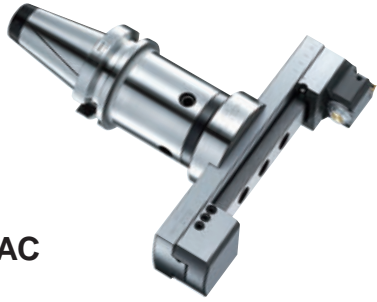
★Bits included for MBT40-DJ8-94AN : J16-8-40, J16-18-60, J16-28-65, J16-38-65

★DJ Boring Bar without Boring Bits is also available. Please add "-BD" at the end of Code No. e.g. MBT40-DJ3-86-BD

★Shank and DJ Head (including Boring Bits) are delivered in separate packages.

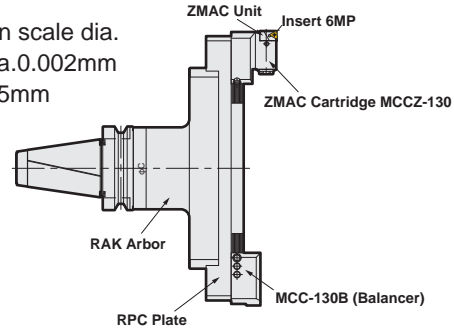
★Please refer P.84 for Boring Bits. Please refer P.97 for cutting condition.

3LOCK BALANCE-CUT BAC BORING ARBOR for LARGE DIA. NIKKEN



BAC

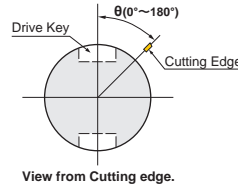
- Min. dial read out: main scale dia. 0.02mm, sub scale dia. 0.002mm
- Boring Dia: $\phi 130 \sim 595\text{mm}$



Boring Dia: $\phi 130 \sim 595\text{mm}$ for Finishing.

TAPER	Code.No	D		L	C	Arbor No.	RPC Plate No	Cartridge (Balancer)	Weight (kg)
		MIN.	MAX.						
No.40	MBT40 -BAC130-205	130	195	205	61	MBT40-RAK-130	RPC-130	MCCZ-130 (MCC-130B)	6.8
	(MIT40) -BAC180-205	180	245				-180		7.8
No.50	MBT50 -BAC130-185, 235, 285	130	195	185, 235, 285	90	MBT50-RAK-110A, -160A, -210A	RPC-130	MCCZ-130 (MCC-130B)	13.0, 14.5, 17.5
	(MIT50) -BAC180-185, 235, 285	180	245				-180		13.5, 15.0, 18.0
	-BAC230-185, 235, 285	230	295				-230		14.0, 15.5, 18.5
	-BAC280-185, 235, 285	280	345	210 (220*)	98	MBT50-RAK330-125 MIT50-RAK330-135	-280	Insert Tip 6MP	14.5, 16.0, 19.0
	-BAC330-210*	330	395				RPC-330		16.2
	-BAC380-210*	380	445				-380		16.5
	-BAC430-210*	430	495				-430		17.5
	-BAC480-210*	480	545				-480		18.5
	-BAC530-210*	530	595				-530		19.5

- ★ "C" grade (Coated) Inserts are supplied as standard. Please refer P.96 for cutting condition.
- ★ Unit "M5HZ-55" is provided as standard, please refer P.72 for Arbor (RAK) and Plate (RPC).
- ★ Arbor, Plate and Cartridge are delivered in separate packages.
- ★ When ordering, please let us know machine maker and model no. to avoid the interference with tool magazine of ATC.
- ★ The location of cutting edge is same as drive key in standard.
- ★ The different location is available, please specify θ in Code No. e.g. MBT50-BAC180-235 (90°)
- ★ The boring arbors marked* with MIT50, L (gauge length) is 220. e.g. MIT50-BAC330-220

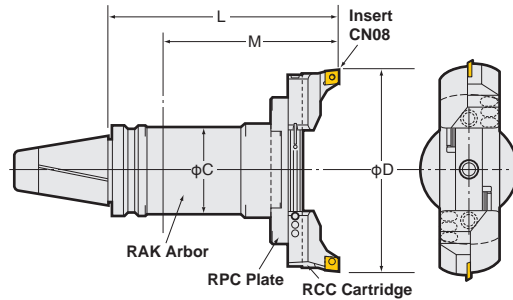


3LOCK BALANCE-CUT BAC BORING ARBOR for LARGE DIA. NIKKEN



RAC

- With slight adjust screw
- Boring Dia: $\phi 130 \sim 580\text{mm}$



Boring Dia: $\phi 130 \sim 580\text{mm}$ for Roughing.

TAPER	Code.No	D		L	C	Arbor No.	RPC Plate No	Cartridge No. for Large dia.	Weight (kg)
		MIN.	MAX.						
No.40	MBT40 -RAC130-205	130	180	205	61	MBT40-RAK-130	RPC-130		6.8
	(MIT40) -RAC180-205	180	230				-180		7.8
No.50	MBT50 -RAC130-185, 235, 285	130	180	185, 235, 285	90	MBT50-RAK-110A, -160A, -210A	RPC-130	For Heavy Duty Boring of Iron and Cast Iron	11.3, 12.8, 15.8
	(MIT50) -RAC180-185, 235, 285	180	230				-180		11.8, 13.3, 16.3
	-RAC230-185, 235, 285	230	280				-230		12.3, 13.8, 16.8
	-RAC280-185, 235, 285	280	330	210 (220*)	98	MBT50-RAK330-125 MIT50-RAK330-135	-280	RCC-130 x2	12.8, 14.3, 17.3
	-RAC330-210*	330	380				RPC-330		15.5
	-RAC380-210*	380	430				-380		16.5
	-RAC430-210*	430	480				-430		17.5
	-RAC480-210*	480	530				-480		18.5
	-RAC530-210*	530	580				-530		19.5

- ★ The Code No. on above table are the boring arbors with RCC-130 cartridge (Insert tip: CN08) the Heavy Duty Boring of Iron and Cast Iron. Please refer P.95 for cutting condition.
- ★ Boring arbor with cartridges & insert for Steel, Stainless Steel and Cast Iron (E), for Aluminum (A) and for Through Hole & Multi Sheets (K) are available. Please refer P.72 for cartridges. e.g. MBT50-RAC130-185E
- ★ Please refer P.72 for Arbor (RAK) and Plate (RPC).
- ★ Arbor, Plate and Cartridge are delivered in separate packages.
- ★ When ordering, please let us know machine maker and model no. to avoid the interference with tool magazine of ATC.
- ★ The location of cutting edge is same as drive key in standard.
- ★ The different location is available, please specify θ in Code No. e.g. MBT50-RAC180-235 (90°)
- ★ The boring arbors marked* with MIT50, L (gauge length) is 220. e.g. MIT50-RAC330-220

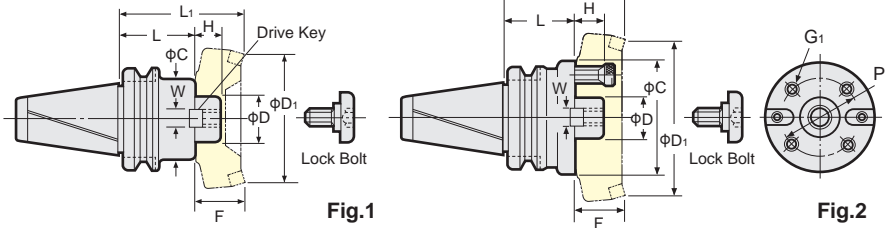
3LOCK

3LOCK MBT FACE MILL ARBOR TYPE A/SHOULDER CUTTER ARBOR



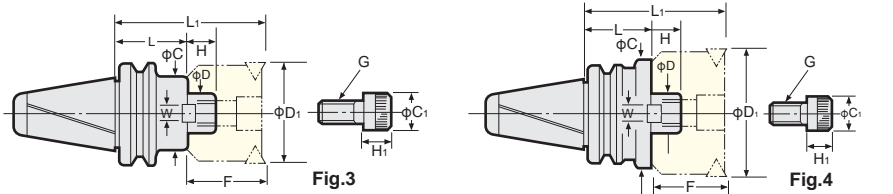
FMA
Photo shows with face mill cutter.

JIS B4113 Face Mill Cutter



3LOCK tooling (MBT) can be used as the triple contact tooling on the M/C where spindle is BT double face contact system.

TAPER	Code No. (ϕD -L)	Arbor			Weight (kg)	With Cutter			Drive Key	Lock Bolt	Fig.
		H	C	W		L ₁	D ₁	F			
No.40	MBT40-FMA25.4 - 45, 90	22	50	9.5	1.5, 3.1	95,140	80	50	FW 5	FM12	1
	-FMA31.75 - 45, 75	30	60	12.7	1.7, 3.1	105,135	100		FW13	FM16	
	-FMA38.1 - 60	34	80	15.9	2.9	120	125	60	FW18	FM20	
No.50	MBT50-FMA25.4 - 45, 90,150	22	58	9.5	3.7, 4.6, 5.5	95,140,200	80	50	FW 5	FM12	1
	-FMA31.75 - 45, 75,105	30	70	12.7	4.5, 5.3, 6.1	105,135,165	100		FW12,13	FM16	
	-FMA38.1 - 45, 75	34	80	15.9	4.3, 5.6		125	60	FW18,19	FM20	
	-FMA50.8 - 45, 75	36	100	19	4.9, 6.8	105,135	160		FW23,24	FM24	
	-FMA47.625- 75*	38	128.57	25.4	7.7	135	200		FW26	*	



3LOCK tooling (MBT) can be used as the triple contact tooling on the M/C where spindle is BT double face contact system.

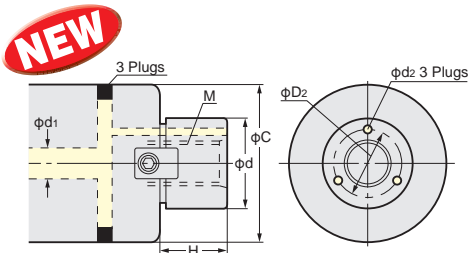
FMC

TAPER	Code No. (ϕD -L)	Arbor			Weight (kg)	With Cutter			C ₁	H ₁	Fig.	
		H	C	W		L ₁	D ₁	F				
No.40	MBT40-FMC22-45, 90	18	45	10	1.3, 2.0	85, 130	50	40	M10×30	16	10	3
	-FMC27-60, 90	20	60	12	1.5, 2.2	110, 140	80		M12×35	18	12	4
	-FMC32-60, 75	22	85	14	2.3, 2.6	110, 125	125	50	M16×35	24	16	
No.50	MBT50-FMC22-60,105,150	18	45	10	4.2, 4.7, 5.3	100,145,190	50	40	M10×30	16	10	3
	-FMC27-45, 90,150	20	70	12	4.1, 5.5, 7.3	95,140,200	80		M12×35	18	12	
	-FMC32-45, 75,105	22	85	14	4.2, 5.5, 7.0	95,125,155	125	50	M16×35	24	16	

- ★ Drive keys, L wrench and bolt are supplied as standard.
- ★ The arbor weight is only for the arbor.
- ★ The different type of the cap bolt may be used for the recent cutter. Please check the specification.
- ★ The arbor marked * requires 4 fixing bolts (FMA47.625 : M16, P=101.6)
- ★ Extended length is available as an option. MBT50-FMA25.4 -200, 250, ...500
-FMA31.75-150, 200, ...500
-FMA38.1 -150, 200, ...500



High Feed Cutter Arbor with Coolant Hole



Code No.	Cutter Dia.	ϕd	ϕC	M	H	Coolant Hole		
						ϕD_2	ϕd_1	ϕd_2
FMH22 (22.225)	$\phi 50, \phi 52$	22(22.225)	47	M10×1.5	18(17)	16	6~8	3
	$\phi 63, \phi 66$		60					
FMH27 (25.4)	$\phi 80$	27(25.4)	76(70)	M12×1.75	20(22)	19.5(18.5)	8~10	3.5
FMH32 (31.75)	$\phi 100$	32(31.75)	96	M16×2.0	22(30)	24	10~13	4
FMH40 (38.1)	$\phi 125$	40(38.1)	100	M20×2.5	26(34)	30(29)	10~15	5
FMH50.8	$\phi 160$	50.8		M24×3.0	36	37.5	15~20	7

★ Fixing dimension is basically based on FMA/FMC. ★ The combination of the other cutter dia. are also available.

3LOCK tooling (MBT) can be used as the triple contact tooling on the M/C where spindle is BT double face contact system.

FMH High Feed Cutter Arbor with Coolant Hole

TAPER	Code No. (ϕD - ϕC -L)	Arbor						Weight (kg)	Drive Key	Lock Bolt	G Cap Bolt
		H	C	W	C ₁	C ₂	H ₁				
No.40	MBT40-FMH22 - 47(60)-45	18	47(60)	10	16		10	1.3(1.4)	FW 8		M10×30
	-FMH27 - 60(76)-60	20	60(76)	12	18		12	1.8(2.2)	FW11		M12×35
	-FMH32 - 96-60	22	96	14	24		16	2.9	FW16		M16×35
	-FMH40 -100-60	26	100	16	50	27	14	6	3.1	FW22	FM20
No.50	MBT50-FMH22 - 47(60)-60	18	47(60)	10	16		10	4.2(4.5)	FW 8		M10×30
	-FMH27 - 60(76)-45	20	60(76)	12	18		12	3.9(4.1)	FW10		M12×35
	-FMH32 - 96-45	22	96	14	24		16	4.2	FW15		M16×35
	-FMH40 -100-45	26		16	50	27	6	5.1	FW20	FM20	
	-FMH50.8 -100-45	36	100	19	65	37	14	10	4.4	FW23	FM24

★ FMH22.225, FMH25.4, FMH31.75, FMH38.1 are also available.

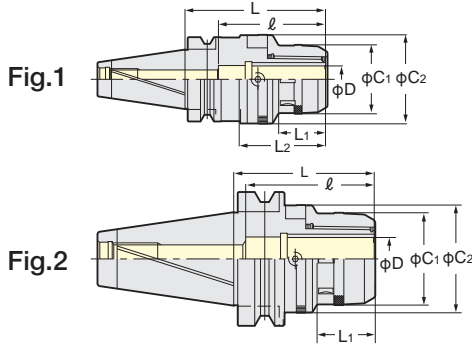
★ For FMH22, there are two types of ϕC , $\phi 47$ and $\phi 60$.
For FMH27, there are two types of ϕC , $\phi 60$ and $\phi 76$.

3LOCK MBT ZERO FIT TYPE MILLING CHUCK

NIKKEN



NEW



Explanation of the Code No.

MBT40 - CZF20 - 105

- Nominal Gauge Length
- Chucking Capacity ϕD
- Zero Fit Type Milling Chuck
- Shank No.

CZF

3LOCK tooling (MBT) can be used as the triple contact tooling on the M/C where spindle is BT double face contact system.

PAT.

TAPER	Code No.	C1	C2	L	L1	L2	l	Weight(kg)	Fig.	Collet
No.40	MBT40-CZF20-105, 120	51.5	66.5	105, 120	35	64.5	80	2.1, 2.5	1	KM20 CCK20
	-CZF25-105, 120	59.5	74.5			68		2.4, 2.9		KM25 CCK25
	-CZF32-120	69	80.5	120	42	81		105		2.8
No.50	MBT50-CZF20-105, 165	51.5	66.5	105, 165	35	-	80	4.6, 6.0	2	KM20 CCK20
	-CZF25-105, 165	59.5	74.5			5.0, 6.8		KM25 CCK25		
	-CZF32-105, 165	69	80.5	42	105	5.3, 7.4		KM32 CCK32		

★Spanner is available as an option.

CZF20 type : 9HC22, CZF25 type : 9HC25, CZF32 type : 9HC32

★Wrench to adjust run-out(9ZFL) is available as an option.

Wrench to adjust
9ZFL



★For How to Adjust the Run-Out, please refer P.156.

★Please note that the acceptable shank tolerance is h_6-h_7 .

★Please add "P" at the end of Code No. for the high speed type. e.g. MBT40-CZF25-105P

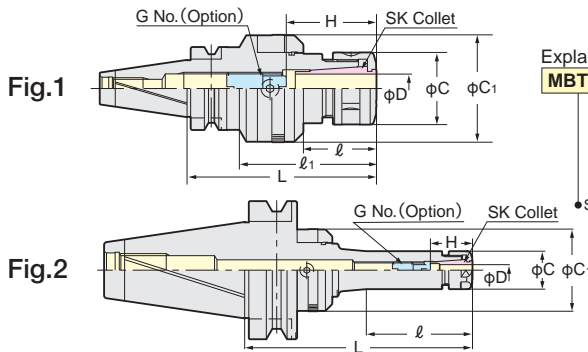
★Please refer P.31, P.32 for KM, CCK collet.

3LOCK MBT ZERO FIT TYPE SLIM CHUCK

NIKKEN



NEW



Explanation of the Code No.

MBT40 - SZF10 C - 90

- Nominal Gauge Length
- High Pressure Centre Through
- Chucking Capacity
- Zero Fit Type Slim Chuck
- Shank No.

SZF

3LOCK tooling (MBT) can be used as the triple contact tooling on the M/C where spindle is BT double face contact system.

PAT.

TAPER	Code No.	D	L	l	l1	C	C1	H	G No.(Option)	Weight(Kg)	Fig.	Collet
No.40	MBT40-SZF 6C- 90,150	0.7~6.0	90, 150	37, 60	-	19.5	40.5,48.5	26~31	SKG 6- 6HG	1.3, 1.7	2	SK 6
	-SZF10C- 90,150	1.75~10.0		37, 97		27.5	48.5	35~41	SKG10-10HG	1.5, 1.9		SK10
	-SZF16C- 90,150	2.75~16.0	55, 86	84, 114	40	59.5	45~57	SKG16-12HG	1.8, 2.2	SK16		
	-SZF25C-120,150	7.5~25.4	120, 150	55, 86	84, 114	55	66.5	60~65	SKG25-18HGD	2.4, 2.9	1	SK25
No.50	MBT50-SZF 6C-105,165	0.7~6.0	105, 165	41, 63	-	19.5	40.5,59.5	26~31	SKG 6- 6HG	4.0, 4.2	2	SK 6
	-SZF10C-105,165	1.75~10.0		41, 101		27.5	48.5	35~41	SKG10-10HG	4.5, 4.9		SK10
	-SZF16C-105,165	2.75~16.0	71, 101	71, 101	40	59.5	45~57	SKG16-12HG	5.0, 5.4	SK16		
	-SZF25C-135,165	7.5~25.4	135, 165	71, 101	71, 101	55	66.5	60~70	SKG25-24HG	5.8, 6.0	1	SK25

★Adjust screw(G No.), wrench to adjust run-out(9ZFL) and SKL spanner are available as an option. SZF6C: SKL-6W, SZF10C: SKL-10, SZF16C: 9HC16, SZF25C: 9HC25

★Please use "P" class or "A" type SK collet. P.145

★For centre through coolant application please use SK J type nut and cap for your preference. Please note that the length of J type nut is 6mm longer than the standard SK Nut. P.43, P.44

★For High Speed type, Code No. is "GSZF-P". e.g. MBT40-GSZF10C-90P

In this case, GH Handle is required. P.30

★For How to Adjust the Run-Out, please refer P.156.

• Drill chuck, side lock holder or morse taper sleeve are not supplied with 3LOCK shank. To prevent the swarf contamination to the gap between spindle flange and tool flange, these kinds of chucks with 2LOCK shank is available.

3LOCK

3LOCK SPINDLE FLANGE CLEANER

NIKKEN

NEW



CLEF

JAPAN PAT.P

Spindle Flange Cleaner for **3LOCK** Tooling and NC5 Tooling.

■ Let's clean your spindle flange just before the fine machining to keep ATC repeatability accuracy higher.

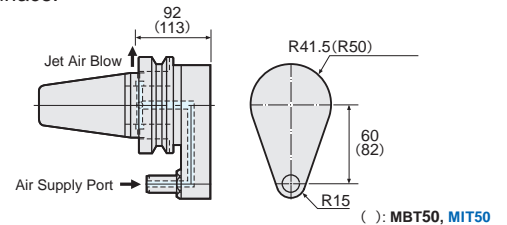
Do not rotate your spindle, just supply the 0.5MPa dry air from the stopper block in approx. 30sec., then the intermittent jet air blow from the spindle flange cleaner will clean your spindle flange surface.

MBT40-CLEF- 92

MBT50-CLEF-113

MIT40-CLEF- 92

MIT50-CLEF-113



★Stopper Block is not included. When ordering, please specify the name of M/C builder, model No. and the drawing of the spindle flange. P.266

SPINDLE TAPER CLEANER

NIKKEN



CLE

■ Let's clean your spindle taper just before the fine machining.

Rotate your spindle at 50~150min⁻¹, then the spindle cleaner will rotate to clean your spindle taper.

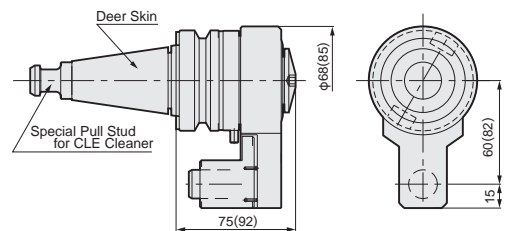
Please be careful, MAX. rotation speed of your spindle is 150min⁻¹.

BT40-CLE-100

BT50-CLE-120

IT40-CLE-100

IT50-CLE-120



★Special Pull Stud for CLE Cleaner is supplied as standard. Please specify the Pull Stud Code No.

★Stopper Block is not included. When ordering, please specify the name of M/C builder, model No. and the drawing of the spindle flange. P.266

AUTOMATIC OIL SUPPLY HOLDER

NIKKEN



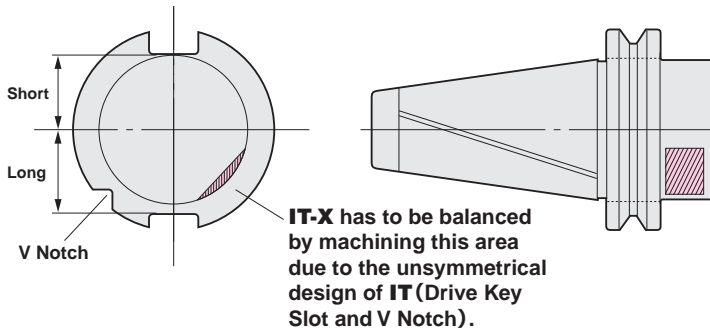
ZP

■ For Improvement of Tap run-out accuracy and extended tap life.

Automatic oil or grease supply of a required amount can be done with this holder before your tapping operation.

TAPER	Code No.	φD ₁	φD ₂	L	Capacity of tank	Discharge /Stroke	Weight (Kg)	Nozzle (Standard Accessories)
No.30	BT30-ZP60-200	60	64	200	100cm ³	0~3.0cm ³	1.2	ZP-10, ZP-10G, ZP-20
No.40	BT40-ZP80-279	80	84	279	300cm ³	0~3.5cm ³	3.3	ZP-10, ZP-10G, ZP-20, ZP-30
No.50	BT50-ZP95-312	96	100	312	500cm ³	0~3.5cm ³	6.0	

What is MIT Shank Tooling?



MIT Shank is **3LOCK SYSTEM** for IT shank. IT shank is based on ISO 7388/1-'83 (DIN69871-'90) and its flange has an unsymmetrical shape.

- Depth of Drive Key Slots are different.
- V Notch on one side.

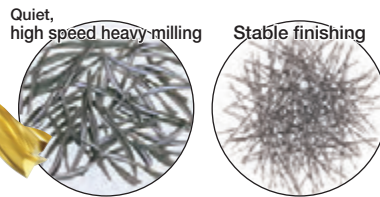
Therefore, MIT shank Multi-Lock Milling Chuck, MINI-MINI Chuck, Slim Chuck and VC Holder have a flat cut just under the V flange for mass balancing as standard.

3LOCK

3LOCK MIT MULTI LOCK MILLING CHUCK

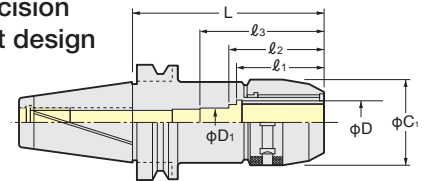


The cutting chips show us the actual machining capability.



ANNIVERSARY Type

- Powerful gripping torque -
- High rigidity
- High precision
- Compact design



TAPER	Code No.	C ₁	D	D ₁	l ₁	l ₂	l ₃	Collet	Weight (kg)
No.40	MIT40-C12- 90, 120 st	33	12	12	48	53	58	KM12 CCK12	1.6, 1.9
	-C16- 60, 90, 120	44	16	16	51	58	65	KM16 CCK16	1.4, 1.7, 2.0
	-C20- 80, 90, 120	52	20	20	59	66	80	KM20 CCK16 CCNK16	1.6, 1.8, 2.2
	-C25- 85, 120	60	25	25	61	70,72	75,80	KM25 CCK25 CCNK25	2.1, 2.5
	-C32- 95 st , 105, 120	64	32	25	67	82,81,77	-,95,107	KM32 CCK32 CCNK32	2.1, 2.5, 2.8
No.50	MIT50-C12-105, 165 st	33	12	12	48	53	58	KM12 CCK12	4.0, 4.6
	-C16-105, 165 st , 200 st	44	16	16	51	58	65	KM16 CCK16	4.2, 4.8, 5.1
	-C20-105, 165 st , 200 st	52	20	20	59	66	80	KM20 CCK20 CCNK20	4.5, 5.1, 5.7
	-C25-105, 135 st , 165 st	60	25	25	61	72	80	KM25 CCK25 CCNK25	4.8, 5.2, 5.6
	-C32- 90, 105, 120, 135, 165	69	32	25	70	81	107	KM32 CCK32 CCNK32	4.3, 4.6, 5.1, 5.6, 6.4
	-C42- 95 st , 120 st , 135 st , 165 st	86	42	42	74	80,100,115,115	85,110,125,125	KM42 CCK42 CCNK42	5.5, 6.6, 7.2, 8.6

- ★Spanner is available as an option.
- C12(φ30) : 9HC12, C12A(φ33) : 9HC12A, C16:9HC16, C20:9HC20, C25:9HC25, C32&φC1=64:9HC25, C32:9HC32, C42:9HC42
- ★Please note the acceptable shank tolerance is h7.
- ★Please refer to P.142 for KM, CCK and CCNK collets.
- ★For heavy duty milling, please grip the end mill shank longer than l₁.
- ★For the chucks except*, the stopper for direct chucking, ONK collet and OJK collet can be used.
- The Code No. of the stopper C20:9MC20, C25:9MC25, C32:9MC32, C42:9MC42
- ★CCNK Collet can not be used for MIT50-C42-95st.
- ★MIT Milling Chucks marked *1 are available as an option.
- ★MIT50-C32-200, 250 and MIT50-C42-200, 250 are available as an option.
- ★C22 style is available.
- ★Please add "F" for the flange through tool coolant type;
 - MIT40-C20F- 90, MIT50-C20F-105
 - C25F- 90, -C25F-105
 - C32F-105, -C32F-105
 - C32F-105, -C42F-120



High Speed Milling Chuck



Code No.	MAX. (min ⁻¹)	Code No.	MAX. (min ⁻¹)
MIT40-C12- 90G	30,000	MIT50-C12-105G	20,000
-C16- 60G	25,000	-C16-105G	
-C20- 80G	20,000	-C20-105G	15,000
-C25- 85G		-C25-105G	
-C32- 95G st , 105G		-C32- 90G, 105G, 120G	
		-C42- 95P st	

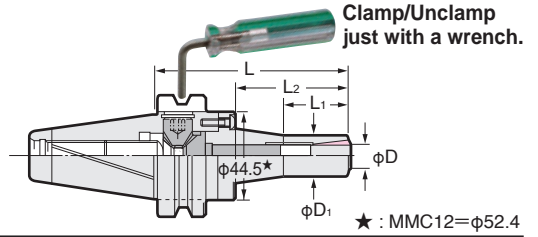
- ★For the chucks except*, the stopper for direct chucking, ONK collet and OJK collet can be used.
- ★CCNK Collet can not be used for MIT50-C42-95st.
- ★The extended gauge length(L) is available. Please contact with us.

3LOCK MIT MINI-MINI CHUCK

The best chuck for the small dia. cutting tool



MAX. 30,000min⁻¹ & G2.5
Gripping from Front Nose
Run-Out Accuracy: 3µm at 4D



MMC

TAPER	Code No.	Chucking Range φD	L	φD ₁	L ₁	Collet	MAX.(min ⁻¹)	Weight (kg)
No.40	MIT40-MMC 8- 90,120	2~ 8	90,120	20	33,40	PMK 8 VMK 8	30,000	1.4 , 1.5
	-MMC12- 90,120	4~12	90,120	30	35,60	PMK12 VMK12	30,000	1.7 , 1.8
No.50	MIT50-MMC 8-105,135,165	2~ 8	105,135,165	20	33,40,40	PMK 8 VMK 8	20,000	4.4, 4.5, 4.6
	-MMC12-105,135,165	4~12	105,135,165	30	35,60,70	PMK12 VMK12	20,000	4.6, 4.7, 4.8

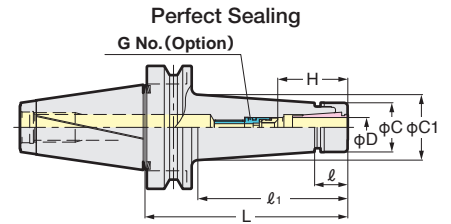
★Wrench is supplied as standard. ★MPK, PMK, VMK collet is available as an option. Please refer P.32
★Please add "C" for the centre through tool coolant type. e.g. MIT40-MMC8C-90
★Please add "F" for the flange through tool coolant type; MIT40-MMC 8F-90,120 MIT50-MMC 8F-105,120
-MMC12F-90,120 -MMC12F-105,120

3LOCK MIT SLIM CHUCK

Dampening effect



Jet Spray Coolant Supply
II
Over 3 times of extended Tool life
(for HSS & Carbide Drills)



When SK J type nut is used, the total chuck length will be extended by 6mm.

TAPER	Code No.	D	L	ℓ	ℓ ₁	C	C ₁	H	G No. (Option)	Weight (kg)	SK Collet
No.40	MIT40-SKT 6C- 90, 120	0.7~6.0	90,120	19.8	60,90	19.5	25.2, 29.4	26~31	SKG 6- 6HG	1.1,1.4	SK 6
	-SKT10C- 90, 120, 150	1.75~10.0	90,120,150	22	60,90,120	27.5	32.9, 37.1, 41.3	35~41	SKG10-10HG	1.2,1.4,1.6	SK10
	-SKT13C- 90, 120, 150	2.75~13.0	90,120,150	26	52,85,110	33	36.6, 41.2, 44.7	39~51	SKG13-10HG	1.4,1.6,1.8	SK13
	-SKT16C- 90, 120, 150	2.75~16.0	90,120,150	27	60,90,120	40	44.7, 48.9, 53.1	45~57	SKG16-12HG	1.5,1.7,1.9	SK16
	-SKT20C- 90, 120	4.0~20.0	90,120	28.5	60,92	48.5	53.0, 57.4	47~63	SKG20-18HG	1.6,2.0	SK20
	-SKT25C- 90, 120	8.0~25.4	90,120	31	62.6, 92.2	55	59.5, 59.3	60~65	SKG25-18HGD	1.8,2.4	SK25
No.50	MIT50-SKT 6C-105, 165	0.7~6.0	105,165	19.8	62,122	19.5	25.5, 33.8	26~31	SKG 6- 6HG	3.8,4.0	SK 6
	-SKT10C-105, 165	1.75~10.0	105,165	22	62,122	27.5	33.1, 41.5	35~41	SKG10-10HG	4.2,4.6	SK10
	-SKT13C-105, 165	2.75~13.0	105,165	26	65,125	33	38.4, 46.8	39~51	SKG13-10HG	4.0,4.3	SK13
	-SKT16C-105, 165	2.75~16.0	105,165	27	62,122	40	44.9, 53.3	45~57	SKG16-12HG	4.7,5.1	SK16
	-SKT20C-105, 165	4.0~20.0	105,165	28.5	62,122	48.5	53.2, 61.6	47~63	SKG20-18HG	4.3,5.0	SK20
	-SKT25C-105, 165	8.0~25.4	105,165	31	62,122	55	59.4, 67.8	60~70	SKG25-24HG	5.2,5.6	SK25

★Adjust screw (G No.) of MIT40-SKT25C-90* is SKG25-18HGD.
★Collet, adjust screw (G No.) and GH Handle are available as an option.
The Code No. of the GH Handle is SKT6C-P: GH6, SKT10C-P: GH10, SKT13C-P: GH13, SKT16C-P: GH16, SKT20C-P: GH20, SKT25C-P: GH25
★Please refer P.145 for SK collet and please refer P.43 for J type nut.
★All chucks are high pressure centre through tool coolant type.
SK6C: φ4~φ6, SK10C: φ6~φ10, SK16C: φ10~φ16, SK25C: φ16~φ25
★Please add "F" for the flange through tool coolant type;
MIT40-SK 6F- 90,120 MIT50-SK 6F-105,165
-SK10F- 90,120 -SK10F-105,165
-SK13F- 90,120 -SK13F-105,165
-SK16F- 90,120 -SK16F-105,165
-SK25F-120 -SK25F-105,165



High Speed SLIM CHUCK



GH Handle P.30

Code No.	MAX. (min ⁻¹)	Code No.	MAX. (min ⁻¹)
MIT40-SKT 6C- 90P, 120P	30,000	MIT50-SKT 6C-105P, 165P	20,000
-SKT10C- 90P, 120P		-SKT10C-105P, 165P	
-SKT13C- 90P, 120P		-SKT13C-105P, 165P	
-SKT16C- 90P, 120P	-SKT16C-105P, 165P		
-SKT20C- 90P, 120P	25,000	-SKT20C-105P, 165P	
-SKT25C- 90P, 120P	20,000	-SKT25C-105P, 165P	

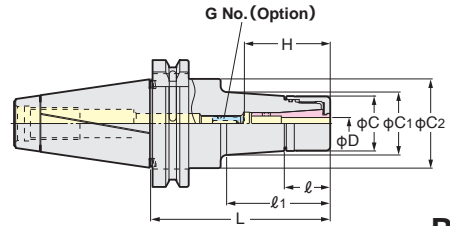
★The extended gauge length (L) is available. Please contact with us.

3LOCK MIT VC HOLDER

NIKKEN



**With TiN Bearing Nut
MAX.40,000min⁻¹ & G2.5
Run-Out Accuracy:3µm at 4D**



PAT.P

TAPER	Code No.	D	L	ℓ	ℓ ₁	C	C ₁	C ₂	H	G No. (Option)	Weight (kg)	MAX. (min ⁻¹)	Collet
No.40	MIT40-VC 6- 60	2.0~6.0	60	23	23	27.5	27.5	44.7	35~45	VCG 6- 8A	1.1	30,000	VCK 6
	- 90										1.3		
	-120										1.5		
	-VC13- 60	3.0~12.0	60	29	70	40	44.7	50~60	VCG13-15A	1.2			
										- 90	1.5		
										-120	1.9		
No.50	MIT50-VC 6-105	2.0~6.0	105	23	64.9	27.5	33.4	70.1	35~45	VCG 6- 8A	3.9	20,000	VCK 6
	-135										4.1		
	-165										4.4		
	-VC13-105	3.0~12.0	105	29	94.9	40	49.2	50~60	VCG13-15A	4.1			
										-135	4.5		
										-165	4.9		

- ★TiN Bearing Nut is supplied as standard.
- ★When the axial stopper is required, please use Adjust Screw (G No.)
- ★Please add "-RP" at the end of Code No. for Rust Proof Treatment VC Holder. e.g. MIT40-VC13-60-RP
- ★Please use VC J type Nut & Cap for Centre Through Coolant.
- When VC J type Nut is used, the total holder length will be extended to 6mm.
- ★MIT40-VC 6-150, MIT40-VC13-150, MIT50-VC13- 90, -120 are available as semi-standard.
- ★Collet, Adjust Screw (G No.) and GH Handle are available an option.
- ★All series are for High Speed Rotation.

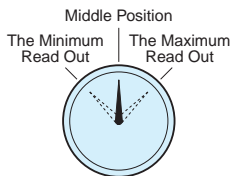
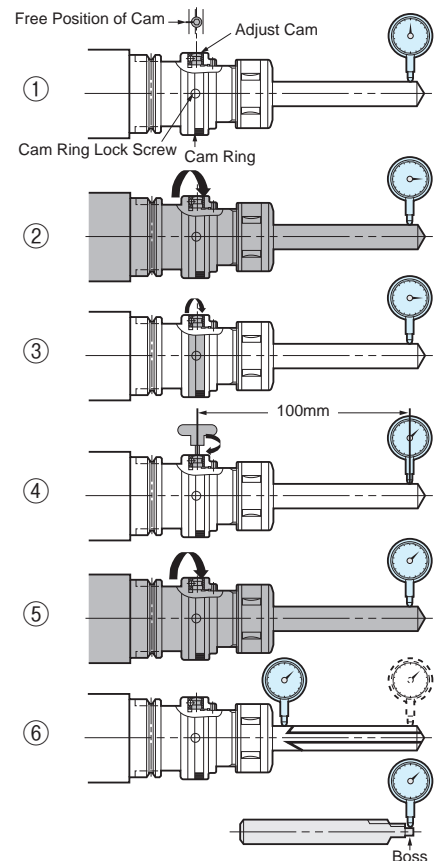


GH Handle P.30

ZERO FIT HOLDER INSTRUCTION (HOW TO ADJUST A RUN-OUT)

NIKKEN

- Loosen 2 off Cam Ring Lock Screws and rotate the Adjust Cam to the free position. Set the Dial Gauge at front end of the cutting tool.
- Rotate the Zero Fit Holder and stop at the position where the Maximum run-out figure is shown.
- Turn the Cam Ring and locate the Adjust Cam to the "Maximum Run-out" position. Turning the Cam Ring is not affected to the balancing grade, because the Cam Ring itself is well balanced.
- Turn the Adjust Cam by wrench (9ZF) to adjust the run-out to be the middle between the maximum and the minimum. Adjustments made with small movements may take some time to achieve the correct accuracy. It is better to try to adjust the full error in one attempt. With practice this becomes easier.



Wrench to adjust 9ZF



Adjustable range of run-out at 100mm from Adjust Cam. (The range will be double at 200mm)		
SZF 6	L < 150	0.050mm / dia.
	L ≥ 150	0.040mm / dia.
SZF10		0.050mm / dia.
SZF16		0.040mm / dia.
SZF25		0.025mm / dia.
CZF20		0.050mm / dia.
CZF25		0.050mm / dia.
CZF32		0.030mm / dia.

- To make sure please rotate the Zero Fit Holder and check the run-out is adjusted correctly. If adjustment is not correct, loosen the screw to get the Adjust Cam back to the free position and repeat the above procedure from (1). Please ensure that the 2 off Cam Ring Lock Screws are tightened after the above operations.
- Please note that there are certain cutters which have the difficulty to check the run-out at their front end. In that case, put the dial gauge on the cylindrical shank portion under the teeth as (6) and proceed the above operation (1)~(5). Then, move the dial gauge to the front end and confirm the run-out. If further fine adjustment is required, please do so by using the Adjust Cam only without rotating the Cam ring. When new special cutter is designed, we will recommend to design to add the boss to check the run-out accuracy at the front end.

3LOCK

3LOCK MIT FACE MILL ARBOR TYPE A/SHOULDER CUTTER ARBOR



Photo shows with face mill cutter.

JIS B4113 Face Mill Cutter

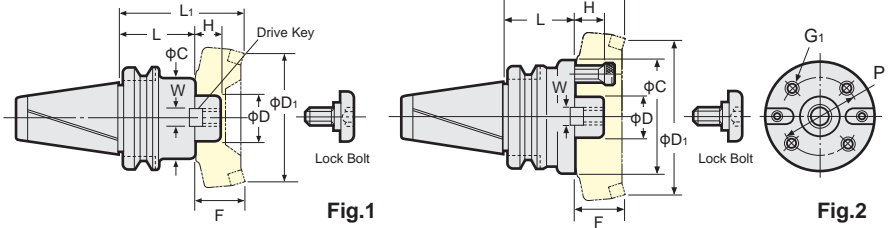


Fig.1

Fig.2

FMA

3LOCK tooling (MIT) can be used as the triple contact tooling on the M/C where spindle is IT double face contact system.

TAPER	Code No. (φD-L)	Arbor			Weight (kg)	With Cutter			Drive Key	Lock Bolt	Fig.
		H	C	W		L ₁	D ₁	F			
No.40	MIT40-FMA25.4 - 45, 90	22	50	9.5	1.5, 3.1	95,140	80	50	FW 5	FM12	1
	-FMA31.75 - 45, 75	30	60	12.7	1.7, 3.1	105,135	100	60	FW13	FM16	
	-FMA38.1 - 60	34	80	15.9	2.9	120	125	60	FW18	FM20	
No.50	MIT50-FMA25.4 - 45, 90,150	22	58	9.5	3.7, 4.6, 5.5	95,140,200	80	50	FW 5	FM12	1
	-FMA31.75 - 45, 75,105	30	70	12.7	4.5, 5.3, 6.1	105,135,165	100	60	FW12,13	FM16	
	-FMA38.1 - 45, 75	34	80	15.9	4.3, 5.6	105,135	125	60	FW18,19	FM20	
	-FMA50.8 - 45, 75	36	100	19	4.9, 6.8	105,135	160	60	FW23,24	FM24	
	-FMA47.625- 75*	38	128.57	25.4	7.7	135	200	60	FW26	*	

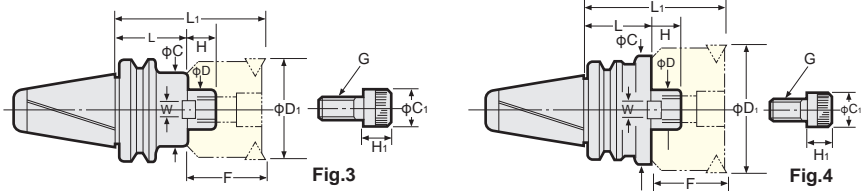


Fig.3

Fig.4

3LOCK tooling (MIT) can be used as the triple contact tooling on the M/C where spindle is IT double face contact system.

FMC

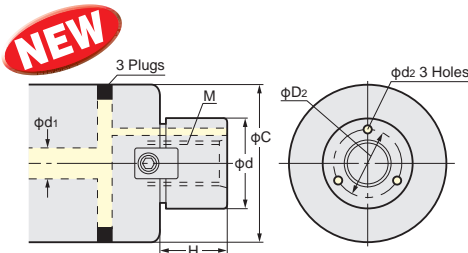
FMA For SANDVIK T-MAX Shoulder Face Mill/SUMITOMO CHE5,000 Series

TAPER	Code No. (φD-L)	Arbor			Weight (kg)	With Cutter			C ₁	H ₁	Fig.	
		H	C	W		L ₁	D ₁	F				G Cap Bolt
No.40	MIT40-FMC22-45, 90	18	45	10	1.3, 2.0	85, 130	50	40	M10×30	16	10	3
	-FMC27-60, 90	20	60	12	1.5, 2.2	110, 140	80	50	M12×35	18	12	4
	-FMC32-60, 75	22	85	14	2.3, 2.6	110, 125	125	50	M16×35	24	16	
No.50	MIT50-FMC22-60,105,150	18	45	10	4.2, 4.7, 5.3	100,145,190	50	40	M10×30	16	10	3
	-FMC27-45, 90,150	20	70	12	4.1, 5.5, 7.3	95,140,200	80	50	M12×35	18	12	
	-FMC32-45, 75,105	22	85	14	4.2, 5.5, 7.0	95,125,155	125	50	M16×35	24	16	

- ★ Drive keys, L wrench and bolt are supplied as standard.
- ★ The arbor weight is only for the arbor.
- ★ The different type of the cap bolt may be used for the recent cutter. Please check the specification.
- ★ The arbor marked * requires 4 fixing bolts (FMA47.625 : M16, P=101.6)
- ★ Extended length is available as an option. MIT50-FMA25.4 -200, 250, ...500
-FMA31.75-150, 200, ...500
-FMA38.1 -150, 200, ...500



High Feed Cutter Arbor with Coolant Hole



Code No.	Cutter Dia.	φd	φC	M	H	Coolant Hole		
						φD ₂	φd ₁	φd ₂
FMH22 (22.225)	φ50, φ52	22(22.225)	47	M10×1.5	18(17)	16	6~8	3
	φ63, φ66		60					
FMH27 (25.4)	φ80	27(25.4)	76(70)	M12×1.75	20(22)	19.5(18.5)	8~10	3.5
FMH32 (31.75)	φ100	32(31.75)	96	M16×2.0	22(30)	24	10~13	4
FMH40 (38.1)	φ125	40(38.1)	100	M20×2.5	26(34)	30(29)	10~15	5
FMH50.8	φ160	50.8	100	M24×3.0	36	37.5	15~20	7

★ Fixing dimension is basically based on FMA/FMC. ★ The combination of the other cutter dia. are also available.

3LOCK tooling (MIT) can be used as the triple contact tooling on the M/C where spindle is IT double face contact system.

FMH High Feed Cutter Arbor with Coolant Hole

TAPER	Code No. (φD-L)	Arbor						Weight (kg)	Drive Key	Lock Bolt	G Cap Bolt
		H	C	W	C ₁	C ₂	H ₁				
No.40	MIT40-FMH22 - 47(60)-45	18	47(60)	10	16		10	1.3(1.4)	FW 8		M10×30
	-FMH27 - 60(76)-60	20	60(76)	12	18		12	1.8(2.2)	FW11		M12×35
	-FMH32 - 96-60	22	96	14	24		16	2.9	FW16		M16×35
	-FMH40 -100-60	26	100	16	50	27	14	6	3.1	FW22	FM20
No.50	MIT50-FMH22 - 47(60)-60	18	47(60)	10	16		10	4.2(4.5)	FW 8		M10×30
	-FMH27 - 60(76)-45	20	60(76)	12	18		12	3.9(4.1)	FW10		M12×35
	-FMH32 - 96-45	22	96	14	24		16	4.2	FW15		M16×35
	-FMH40 -100-45	26		16	50	27	6	5.1	FW20	FM20	
	-FMH50.8 -100-45	36	100	19	65	37	14	10	4.4	FW23	FM24

★ FMH22.225, FMH25.4, FMH31.75, FMH38.1 are also available.

★ For FMH22, there are two types of φC, φ47 and φ60. For FMH27, there are two types of φC, φ60 and φ76.

2LOCK TOOLING SYSTEM

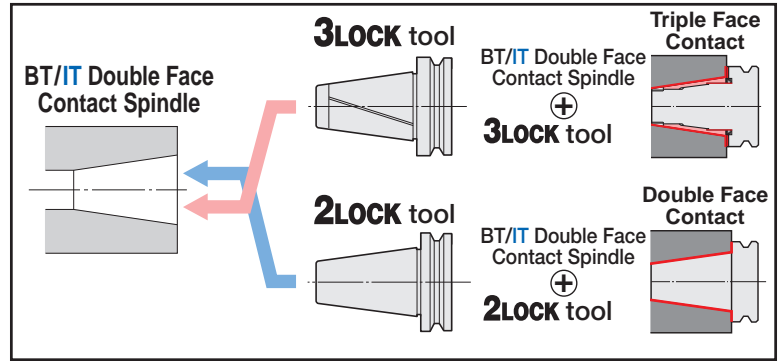
NIKKEN

2LOCK tool(NBT)is created from the technology of the **3LOCK** tool(MBT)with its acclaimed cutting and safe and reliable triple contact type. A series of MAJOR DREAM Holders and high speed tooling were created using the **2LOCK** tool system.

- MIN. Z-axis displacement at high speed rotation
- Improved run-out accuracy of ATC repeatability

Extremely low Z-axis displacement

ATC Repeatability

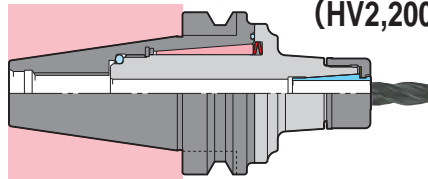


2LOCK tool can also be used on the machine with BT/IT standard spindle.

The Nikken **2LOCK** tooling system is not a simple taper/flange double face contact tool. The built-in dampening mechanism and front chucking mechanism have a variety of features.

MAJOR DREAM Holder P169 ··· Dampening Mechanism ⊕ TiN Bearing Nut (HV2,200)

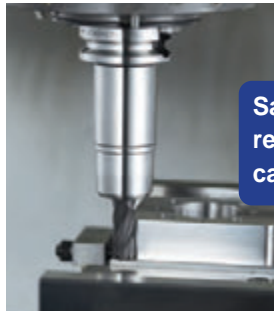
The dampening effect generates the excellent cutting.



Run-Out Accuracy



High Speed Milling Chuck P160



Same Appearance, but a remarkable improvement can be found when cutting.

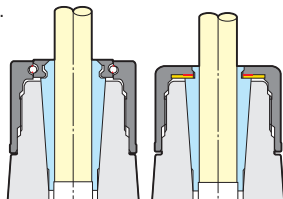
Within 3µm

High Speed Slim Chuck P165, Anniversary type VC Holder P168

Unstable accuracy caused by tightening torque and the possibility of rust.

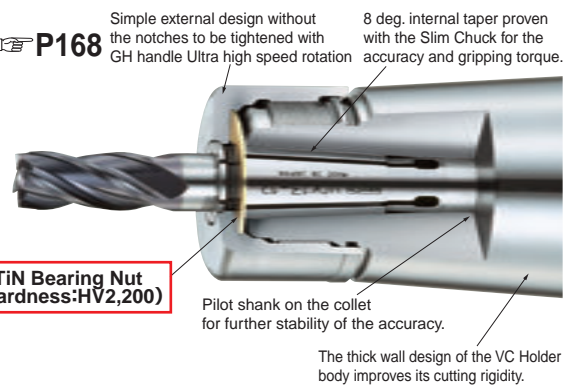


The Tin coated bearing plate reduced friction. This is the best for the thrust load.



Competitors

NIKKEN



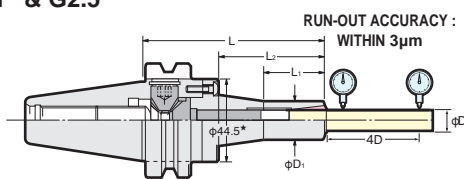
TiN Bearing Nut (Hardness:HV2,200)

Pilot shank on the collet for further stability of the accuracy.

The thick wall design of the VC Holder body improves its cutting rigidity.

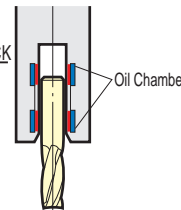
Mini-Mini Chuck P162 ··· Expert for Small Dia. End Milling

30,000min⁻¹ & G2.5

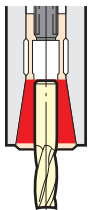


RUN-OUT ACCURACY : WITHIN 3µm

× HYDRAULIC CHUCK
No Gripping at Front Nose
Gripping Torque?



○ MINI-MINI CHUCK
Gripping from Front Nose
Powerful Gripping Torque/3times



⚠ Caution Please read.

If chattering instability occurs during processing with the BT/IT double face contact tool(eg, if the M/C pulling force is reduced), be sure to select the **3LOCK** tool of the internal expanding mechanism. This enables stable cutting by the taper, flange and the internal expanding mechanism.

MBT40, MIT40: Pulling force of 500 kg or greater

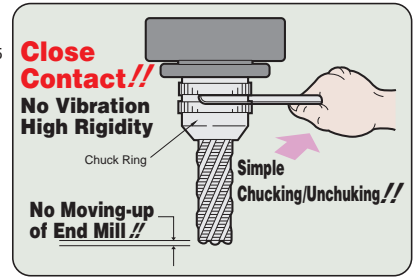
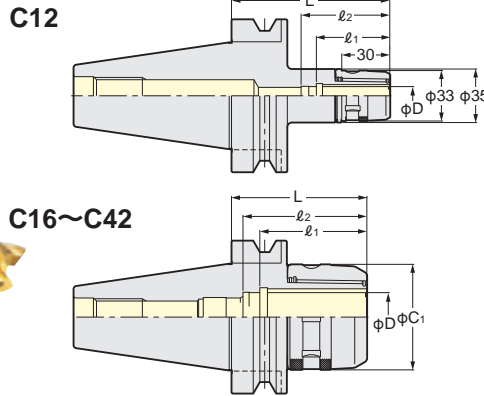
MBT50, MIT50: Pulling force of 1,500 kg or greater

2LOCK

2LOCK MILLING CHUCK

NIKKEN

JAPAN, USA, FRANCE, ITALY, SPAIN, KOREA, TAIWAN PAT. PAT.P
GERMANY PAT.P



C

Centre Through
MAX. 7MPa

2LOCK tooling (NBT) can be used as the double face contact tooling on the M/C where spindle is BT double face contact system.
2LOCK tooling can also be used on the M/C with BT standard spindle.

TAPER	Code No.	C ₁	L	l ₁	l ₂	Collet	Weight(kg)
No.30	NBT30-C12- 55	33	58	48	58	CCK12 KM12	0.6
	-C16- 55	44	57	50	65	CCK16 KM16	0.7
	-C20- 65* ¹ , 75	52	67, 75	57	80	CCK20 CCNK20 KM20 NK20	1.0, 1.1
	-C25- 75* ² , 80	55	75, 82	56	68	CCK25 CCNK25 KM25 NK25	1.2, 1.3
	-C32- 90* ³ , 100	64	90, 100	67	68, 76	CCK32 CCNK32 KM32 NK32	1.4, 1.5
No.40	NBT40-C12- 65, 90, 120	33	65, 90, 120	48	58	CCK12 KM12	1.3, 1.6, 1.9
	-C16- 60, 90, 120	44	63, 90, 120	50	65	CCK16 KM16	1.4, 1.7, 2.0
	-C20- 70, 90, 105, 120	52	71, 90, 105, 120	57	80	CCK20 CCNK20 KM20 NK20	1.6, 1.8, 2.0, 2.2
	-C25- 70, 90, 120	60	70, 90, 120	60		CCK25 CCNK25 KM25 NK25	1.8, 2.1, 2.5
	-C32- 85, 105, 120	69	85, 105, 120	64, 70, 70	77, 81, 81	CCK32 CCNK32 KM32 NK32	2.1, 2.5, 2.8
No.50	NBT50-C12-105, 135, 165	33	105, 135, 165	48	58	CCK12 KM12	4.0, 4.3, 4.6
	-C16-105, 135, 165	44		50	65	CCK16 KM16	4.2, 4.5, 4.8
	-C20-105, 135, 165, 180	52	105, 135, 165, 180	57	80	CCK20 CCNK20 KM20 NK20	4.5, 4.8, 5.1, 5.4
	-C25-105, 135, 165	60	105, 135, 165	60		CCK25 CCNK25 KM25 NK25	4.8, 5.2, 5.6
	-C32- 90, 105, 120, 135, 165 -200, 250, 300	69	90, 105, 120, 135, 165 200, 250, 300	70	81	CCK32 CCNK32 KM32 NK32	4.3, 4.6, 5.1, 5.6, 6.4 7.8, 9.2, 10.6
	-C42- 95, 105, 120, 135, 165 -200, 250, 300	86		73	125	CCK42 CCNK42 KM42 NK42	5.5, 5.8, 6.6, 7.2, 8.6 9.5, 11.7, 14.0

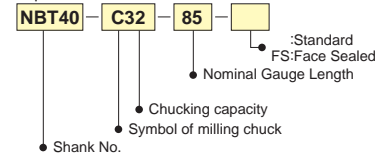
★MULTI LOCK Milling Chuck is a Base Holder for machining centre.

The following straight shank tooling to suit Milling Chucks are available.

[S-C] Milling Chuck (Extension Type) P.31
[K-MMP] MINI-MINI Chuck P.33
[K-MMC] MINI-MINI Chuck P.33
[K-SK] Slim Chuck P.40
[S-SK] Long Size Slim Chuck P.40
[D-NPU] NC Drill Chuck P.45
[NZ] Tapper Chuck P.56

[K-MT] Morse Taper Socket P.47
[K-ZMAC] ZMAC Boring Bar P.89
[K-RAC] RAC Boring Bar P.89
[S-ZMACX] ZMAC Boring Bar for Deep Hole P.90
[K-DJ] DJ Boring Bar P.91
[K-SCA] Stub Arbor P.104
[S-MDPE] PRO-END MILL P.103
[MSO-AO-O] Straight shank shrink fit holder P.172

Explanation of the Code No.



- ★Please refer P.159 for heavy duty type milling chuck with larger arbor diameter.
- ★Please refer P.161 for KM, NK, CCK, CCNK collet.
- ★CKFN-D and CKFN-DC (With O-ring) can be used for the direct chucking application, when centre through tool coolant. CCK collet and CKFN nut can be used for collet application.
- ★For "L" dimension of centre through coolant type milling chuck is same as the above standard, however, refer P.105 for Code No.
- ★For "L" dimension of flange through coolant type milling chuck is same as the above standard, however, refer P.107 for Code No.
- ★Please refer P.57 to use milling chuck as a tap holder for synchronizing tapping.
C25 (φC₁=55mm): 9HC22, C25 (φC₁=60mm): 9HC25, C32 (φC₁=64mm): 9HC25, C32 (φC₁=69mm): 9HC32, C42: 9HC42
- ★Please note the acceptable shank tolerance is h7.
- ★The milling chucks marked *1, *2 and *3 may not be used by the restriction of the diameter under V flange of your M/C.
- ★FS (Face Seal) types are available for C25~C42 of BT40/BT50. There are 2 types; FSJ: With J groove, FS: Without J groove

★Heavy duty type milling chucks with larger arbor diameter are available. Please add "R" at the end of Code No.

NBT50-C32-200R, 250R, 300R
-C42-200R, 250R, 300R



FS type
For machining
of aluminum



2LOCK HIGH SPEED MILLING CHUCK

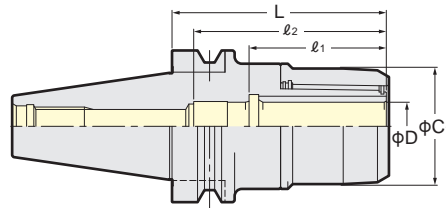


JAPAN, USA, FRANCE, ITALY, SPAIN, KOREA, TAIWAN PAT. GERMANY PAT.P

Anniversary type & High Speed
Applicable for High Pressure
Centre Through Coolant by CCK Collet



C-G



GFS type
For machining
of aluminum

Centre Through
MAX. 7MPa

2LOCK tooling (NBT) can be used as the double face contact tooling on the M/C where spindle is BT double face contact system.
2LOCK tooling can also be used on the M/C with BT standard spindle.

High Speed

PAT.

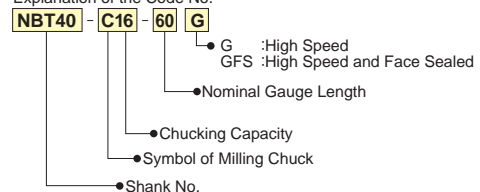
TAPER	Code No.	D	C ₁	L	l ₁	l ₂	MAX. min ⁻¹	Collet	Weight (kg)
No.30	NBT30-C12- 55G	12	33	58	48	58	40,000	CCK12 KM12	0.5
	-C16- 55G	16	40	57	50	65		CCK16 KM16	0.6
	-C20- 65G* ¹ , 75G	20	48	67, 75	57	80	30,000	CCK20 CCNK20 KM20 NK20	0.9, 1.0
	-C25- 75G* ² , 80G	25	55	75, 82	56	68		CCK25 CCNK25 KM25 NK25	1.2, 1.3
	-C32- 90G* ³ , 100G	32	62	90, 100	67	68, 76		CCK32 CCNK32 KM32 NK32	1.4, 1.5
No.40	NBT40-C12- 65G, 90G	12	33	65, 90	48	58	30,000	CCK12 KM12	1.1, 1.3
	-C16- 60G, 90G	16	40	63, 90	50	65		CCK16 KM16	1.2, 1.5
	-C20- 70G, 90G	20	48	71, 90	57	80	25,000	CCK20 CCNK20 KM20 NK20	1.4, 1.7
	-C25- 70G, 90G	25	55	70, 90	60			CCK25 CCNK25 KM25 NK25	1.6, 2.0
	-C32- 85G, 105G	32	68	85, 105	64, 70	77, 81	20,000	CCK32 CCNK32 KM32 NK32	1.9, 2.3
No.50	NBT50-C12-105G, 135G	12	33	105, 135	48	58	20,000	CCK12 KM12	3.9, 4.2
	-C16-105G, 135G	16	40		50	65		CCK16 KM16	4.1, 4.4
	-C20-105G, 135G	20	48		57	80	CCK20 CCNK20 KM20 NK20	4.4, 4.8	
	-C25-105G, 135G	25	55	60	15,000	CCK25 CCNK25 KM25 NK25	4.6, 5.2		
	-C32- 90G, 105G, 120G	32	68	90, 105, 120		70	81	CCK32 CCNK32 KM32 NK32	4.3, 4.7, 5.2
	-C42-* ⁴ 95P, 120P	42	86	95, 120	73	125	12,000	CCK42 CCNK42 KM42 NK42	5.5, 6.6

- ★GH Handle is available as an option. Please refer P.30
- C12-G:GH12, C16-G:GH16, C20-G:GH20, C25-G:GH25, C32-G(φC₁=68mm):GH32, C32-G(φC₁=62mm):GH32S,
- ★Please note the acceptable shank tolerance is h8.
- ★Please add "RP" at the end of Code No. for Rust Proof Treatment Milling Chuck. e.g. NBT40-C32-85G-RP
- ★Centre Through Coolant application:
For direct chucking, CKFN-D nut is recommended.
With a collet, CCK collet and CKFN nut are recommended.
- ★NBT30-C20-65G marked * may not be used by the M/C restriction. In this case, please use NBT30-C20-75G.
- ★NBT50-C42-110P is also available.
- ★Please refer P.161 for KM, NK, CCK and CCNK collet.



CCK collet & CKFN nut
The Jet Coolant Pressure
creates a tornado effect,
ensuring efficient swarf
dispersal.

Explanation of the Code No.



2LOCK

CENTRE COOLANT STRAIGHT COLLET

PAT.



The Jet Coolant Pressure creates a tornado effect, ensuring efficient swarf dispersal.



CCK

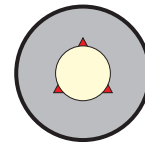
Suitable for all models of the NIKKEN MILLING CHUCK



CCK Collet

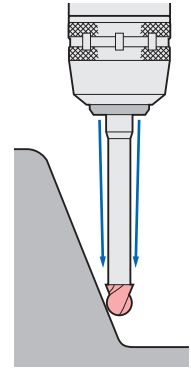


Front Nut

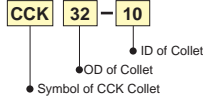


Jet Coolant

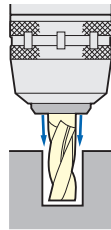
Prevention of Swarf entering the collet through the slots



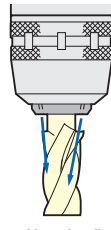
Explanation of the Code No.



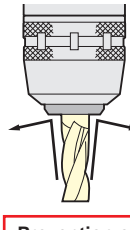
CCK : Centre Coolant
CCNK : Centre Coolant, Adjustable
KM : Standard
NK : Adjustable
ONK : Oil Hole Drill
OJK-A: Jet Coolant
OJK-S: Multiple Nozzles



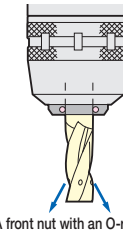
For grooving.



For cutters with cutting diameter which is larger than the shank diameter.



Prevention of the swarf contamination.



A front nut with an O-ring seal, for use with oil hole cutter, is also available as option.



CKFN-MN



CKFN-C

CCK Collet CKFN front nut and CCKL spanner are available as an option.



Photo shows with front nut.

CCK

Style	CCK Collet Code No. (OD-ID)	Front Nut Code No.
CCK12	CCK12-3, 4, 5, 6, 8, 10	CKFN12
CCK16	CCK16-3, 4, 5, 6, 8, 10, 12	CKFN16
CCK20	CCK20-6, 8, 10, 12, 16	CKFN20
CCK25	CCK25-6, 8, 10, 12, 16, 20	CKFN25
CCK32	CCK32-6, 8, 10, 12, 16, 20, 25	CKFN32, CKFN32T
CCK42	CCK42-6, 8, 10, 12, 16, 20, 25, 32	CKFN42

★Above bold figures indicate "ANNIVERSARY" type CCK Collet.
★Please note the acceptable shank tolerance is h_6-h_7 .
★Other metric sizes and imperial sizes, 1/8, 1/4, 5/16, 3/8, 7/16, 1/2, 5/8, 3/4, 13/16, 7/8, 1, 1-1/8, 1-1/4, 1-1/2" are also available.



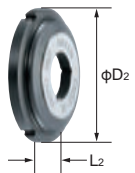
Photo shows with front nut.

CCNK

Style	CCNK Collet Code No. (OD-ID)	Front Nut Code No.
CCNK20	CCNK20-6, 8, 10, 12, 16	CKFN20
CCNK25	CCNK25-6, 8, 10, 12, 16, 20	CKFN25
CCNK32	CCNK32-6, 8, 10, 12, 16, 20, 25	CKFN32, CKFN32T
CCNK42	CCNK42-6, 8, 10, 12, 16, 20, 25, 32	CKFN42

★Please note the acceptable shank tolerance is h_6-h_7 .
★Other metric sizes and imperial sizes, 1/8, 1/4, 5/16, 3/8, 7/16, 1/2, 5/8, 3/4, 13/16, 7/8, 1, 1-1/8, 1-1/4, 1-1/2" are also available.

Front Nut CKFN



Explanation of the Code No.

CKFN 32 - 10

- Symbol of Front Nut
- 32: OD of Collet
- 10: ID of Collet

Style	phi D2	L2	Front Nut Code No.
CKFN12	19.5	7	CKFN12 -3, 4, 5, 6, 8, 10
CKFN16	28.5	8	CKFN16 -3, 4, 5, 6, 8, 10, 12
CKFN20	33	8	CKFN20 -6, 8, 10, 12, 16
CKFN25	39	8.5	CKFN25 -6, 8, 10, 12, 16, 20
CKFN32	46.5	9	CKFN32 -6, 8, 10, 12, 16, 20, 25
CKFN32T	43	9	CKFN32T -6, 8, 10, 12, 16, 20, 25
CKFN42	59.5	9	CKFN42 -6, 8, 10, 12, 16, 20, 25, 32



★The front nut for direct chucking is also available.
e.g. CKFN20-20D, CKFN25-25D, CKFN32-32D

★The Code No. fitted with O-ring is:
e.g. CKFN20-20DC, CKFN25-25DC, CKFN32-32DC

★For C32 there are 2 sizes, CKFN32 = for nose ring diameter of phi 69mm, CKFN32T = for nose ring diameter of phi 64mm.
★Jet Coolant type for the cutter with a cutter dia. larger than shank dia. is also available.
CKFN25-20MN, CKFN32-25MN, CKFN42-32M
★Front Nut fitted with an O-ring is also available.
e.g. The Code No. is CKFN32-10C
★The spanner is available as an option.
CKFN12:CCKL12, CKFN16:CCKL16
CKFN20:CCKL20
CKFN25, CKFN32T:CCKL25
CKFN32:CCKL32, CKFN42:CCKL42



KM Photo shows ANNIVERSARY type KM Collet.

Style	KM Collet Code No. (OD-ID)
KM12	KM12-2, 3, 4, 5, 6, 7, 8, 9, 10
KM16	KM16-2, 3, 4, 5, 6, 7, 8, 9, 10, 11, 12
KM20	KM20-2, 3, 4, 5, 6, 7, 8, 9, 10, 11, 12, 13, 14, 15, 16
KM25	KM25-3, 4, 5, 6, 7, 8, 9, 10, 11, 12, 13, 14, 15, 16, 17, 18, 19, 20, 21, 22
KM32	KM32-3, 4, 5, 6, 7, 8, 9, 10, 11, 12, 13, 14, 15, 16, 17, 18, 19, 20, 21, 22, 23, 24, 25, 26, 30
KM42	KM42-3, 4, 5, 6, 7, 8, 9, 10, 11, 12, 13, 14, 15, 16, 17, 18, 19, 20, 21, 22, 23, 24, 25, 26, 27, 28, 29, 30, 31, 32, 40

★[For Synchronous Tapping Program] : Special ID Collets for Tap Shank are also available.
★Other metric sizes and imperial sizes, 1/8, 1/4, 5/16, 3/8, 7/16, 1/2, 5/8, 3/4, 13/16, 7/8, 1, 1-1/8, 1-1/4, 1-1/2" are also available.
★The collets with bold character are the "ANNIVERSARY" type KM Collet.
Ordinary KM Collet can be used with "ANNIVERSARY" type Milling Chuck, but better performance can be found with the "ANNIVERSARY" type KM Collet.
★Please note the acceptable shank tolerance is h_6-h_7 .

Cutter length adjustment on the collet is possible from front and back.



NK

Style	NK Collet Code No. (OD-ID)
NK20	NK20-3, 4, 5, 6, 7, 8, 9, 10, 11, 12, 13, 14, 15, 16
NK22	NK22-3, 4, 5, 6, 7, 8, 9, 10, 11, 12, 13, 14, 15, 16, 17, 18
NK25	NK25-3, 4, 5, 6, 7, 8, 9, 10, 11, 12, 13, 14, 15, 16, 17, 18, 19, 20, 21, 22
NK32	NK32-3, 4, 5, 6, 7, 8, 9, 10, 11, 12, 13, 14, 15, 16, 17, 18, 19, 20, 21, 22, 23, 24, 25, 26
NK42	NK42-3, 4, 5, 6, 7, 8, 9, 10, 11, 12, 13, 14, 15, 16, 17, 18, 19, 20, 21, 22, 23, 24, 25, 26, 27, 28, 29, 30, 31, 32

★[For Synchronous Tapping Program] : Special ID Collets for Tap Shank are also available.
★Other metric sizes and imperial sizes, 1/8, 1/4, 5/16, 3/8, 7/16, 1/2, 5/8, 3/4, 13/16, 7/8, 1, 1-1/8, 1-1/4, 1-1/2" are also available.
★The collets with bold character are standard.
★Please note the acceptable shank tolerance is h_6-h_7 .
★Collet removal (9CKR) is available as an option.
★Please refer P.31, P.32 for more detail of the straight collet.

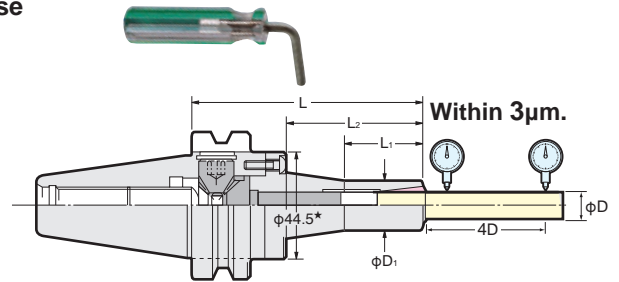


2LOCK MINI-MINI CHUCK EXPERT for SMALL DIA. END MILLING



30,000min⁻¹ & G2.5
Gripping from Front Nose
Run-Out Accuracy:
3μm at 4D

Clamp/Unclamp
just with a wrench.



MMC

2LOCK tooling (NBT) can be used as the double face contact tooling on the M/C where spindle is BT double face contact system.
2LOCK tooling can also be used on the M/C with BT standard spindle.

Dimension marked ★ is φ52.4 for MMC12.

High Speed

TAPER	Code No.	Chucking RangeφD	L	φD ₁	L ₁	L ₂	Collet	MAX.min ⁻¹	Weight(kg)
No.30	NBT30-MMC 4-105	1~ 4	105	15	30	43	MPK 4	30,000	0.9
	-MMC 8-105	2~ 8		20	36	42	PMK 8 VMK 8		0.9
	-MMC 12-105	4~12		30	35	44	PMK12 VMK12		1.1
No.40	NBT40-MMC 4- 90	1~ 4	90	15	30	43	MPK 4	30,000	1.2
	-MMC 8- 90	2~ 8		20	36	42	PMK 8 VMK 8		1.2
	-120		120	43	72		1.3		
	-MMC 12- 90	4~12	90	35	44	PMK12 VMK12	1.4		
	-120		120	60	74		1.5		
No.50	NBT50-MMC 4-105	1~ 4	105	15	30	43	MPK 4	20,000	3.8
	-MMC 8-105	2~ 8		20	36	42	PMK 8 VMK 8		3.8
	-135		135	43	72		3.9		
	-165	165	43	102		4.0			
	-MMC 12-105	4~12	105	35	44	PMK12 VMK12	4.0		
	-135		135	60	74		4.1		
	-165		165	70	104		4.2		

★Wrench is supplied as standard. Collet is available as an option.

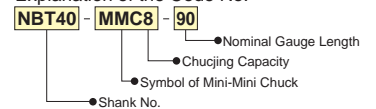
★MMC12 is a NEW type, therefore, Old style collets for MMC12 can not be used with it. Please Use VMK12 or PMK12 Collets.

★Centre Coolant Through type MINI-MINI Chuck is available MMC8 and MMC12 type only.

Please add the letter "C" to the Code No. e.g. NBT40-MMC8C-90 (P.104)

★MPK, PMK, VMK collet is available as an option. Please refer P.32

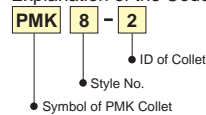
Explanation of the Code No.



PMK Collet Please select PMK collet for the MINI-MINI Chuck without coolant through capability.



Explanation of the Code No.



PMK Collet Code No.
MPK 4-1, 1.5, 2, 2.5, 3, 3.5, 4
PMK 8-2, 2.2, 2.4, ...3, ...4, ...5, ...6, ...7, ...8 (each 0.2mm)
PMK12-4, 5, 6, 8, 10, 12

★Please note the acceptable shank tolerance of MPK Collet is h₆.

★Even the gripping range of PMK collet is 0.2mm/dia. (e.g. PMK8-2 : 1.8~2.0), but the shank tolerance of h₆ is highly recommended for precision machining.

VMK, VMK-J Collet

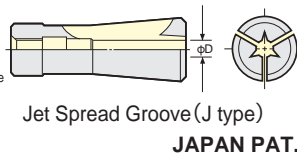
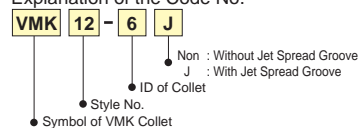
For centre through tool coolant type MINI-MINI Chuck ;

• Standard VMK collet is for the cutting tool with coolant hole.

• VMK-J collet is for the cutting tool without coolant hole.



Explanation of the Code No.



VMK Collet Code No.
VMK 8-2J,3J,4J,5J,6J,8J
VMK12-4J,5J,6J,8J,10J,12J

★Please note the acceptable shank tolerance is h₆.

★Please add "J" for the Jet Spread Coolant type.

e.g. VMK8-6J

★VMK8-2J is Jet Spread Hole type.

2LOCK

2LOCK SLIM CHUCK

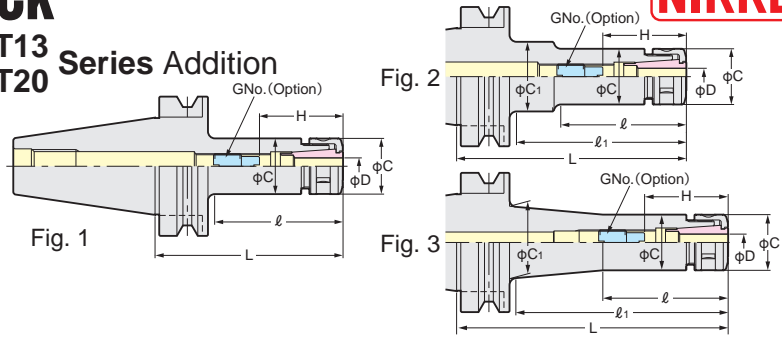


NEW

**SKT13
SKT20 Series Addition**



SK
Photo shows SK10 type.



Centre Through
MAX. 7MPa

2LOCK tooling (NBT) can be used as the double face contact tooling on the M/C where spindle is BT double face contact system.
2LOCK tooling can also be used on the M/C with BT standard spindle.

When SK J type nut is used, the total chuck length will be extended by 6mm.

PAT.

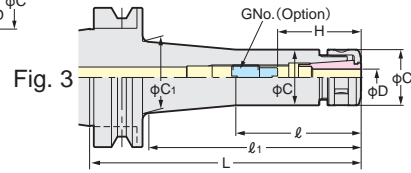
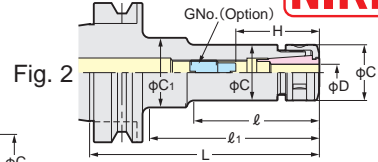
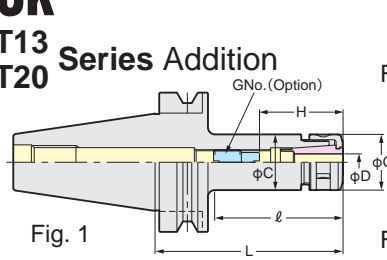
TAPER	Code No.	D	L	l	l ₁	C	C ₁	H	G No. (Option)	Weight (kg)	Fig	Collet	
No.30	NBT30-SK 6C- 60	0.7 ~ 6.0	60	33	33	19.5	19.5	26~31	SKG 6- 6HG	0.7	1	SK 6	
	- 90		90	56	65		32			0.7	2		
	-120		120	62	95		32			0.8			
	-SK10C- 45	1.75~10.0	45	22	22	27.5	27.5	33~41	SKG10-10HG	0.8	1	SK10	
	- 60		60	35	35					0.9			
	- 75		75	50	50					1.0			
	- 90	90	65	65	1.0								
	-120	120	95	95	1.1								
	-SK13C- 60	2.75~13.0	60	35	35	33	33	39~51	SKG13-10HG	1.0	1	SK13	
	- 75		75	50	50					1.1			
	- 90		90	65	65					1.1			
	-120	120	95	95	1.2								
	-SK16C- 60	2.75~16.0	60	37	37	40	40	47~52	SKG16-12HGE	1.1	1	SK16	
	- 75		75	52	52			45~52	SKG16-10HG	1.2			
	- 90		90	67	67			45~57	SKG16-12HG	1.2			
	-120	120	97	97	1.3								
	-SK20 - 60*	3.5~20.0	60	37	37	48.5	48.5	65~70	SKG-12S	0.7	1	SK20	
	-SK20C- 75		75	52	52			50~55	SKG20-12HGE	0.9			
- 90	90		67	67	47~63			SKG20-12HG	1.2				
-SK25 - 90*	7.5~25.4	90	67	67	55	55	55~75	SKG-12	1.5	1	SK25		
No.40	NBT40-SK 6C- 60	0.7 ~ 6.0	60	30	30	19.5	19.5	26~31	SKG 6- 6HG	1.0	1	SK 6	
	- 90		90	51	60		32			1.1	2		
	-120		120	60	90		25			1.4	3		
	-150		150	60	120		25			1.5			
	-SK10C- 60	1.75~10.0	60	32	32	27.5	27.5	33~41	SKG10-10HG	1.1	1	SK10	
	- 75		75	45	45					40	1.2		2
	- 90		90	48	60					40	1.2		
	-120		120	90	90					34.5	1.4		3
	-150		150	118	118					39	1.6		
	-180		180	73	148					39	1.6		
	-200		200	168	168					39	2.0		
	-250		250	218	218					39	2.3		
	-SK13C- 60	2.75~13.0	60	28	28	33	33	39~51	SKG13-10HG	1.2	1	SK13	
	- 75		75	43	43					40	1.3		
	- 90		90	58	58					40	1.4		
	-120		120	88	88					40	1.6		3
	-150		150	118	118					40	1.8		
	-180		180	88	148					40	1.8		
	-200		200	168	168					40	2.2		
	-250		250	218	218					40	2.6		
	-SK16C- 60	2.75~16.0	60	32	32	40	40	45~52	SKG16-10HG	1.3	1	SK16	
	- 75		75	43	43			45~57	SKG16-12HG	1.5			
	- 90		90	58	58			45~57	SKG16-12HG	1.5			
	-120		120	88	88			45~57	SKG16-12HG	1.7			
	-150		150	118	118			45~57	SKG16-12HG	1.9			
	-180		180	148	148			45~57	SKG16-12HG	2.0			
	-200		200	168	168			45~57	SKG16-12HG	2.3			
	-250		250	218	218			45~57	SKG16-12HG	2.8			
	-SK20C- 60	3.5~20.0	60	32	32	48.5	48.5	57~63	SKG20-16HG	1.3	1	SK20	
	- 75		75	45	45			47~63	SKG20-18HG	1.4			
	- 90		90	60	60			47~63	SKG20-18HG	1.6			
	-120		120	90	90			47~63	SKG20-18HG	2.0			
	-SK25C- 75	7.5~25.4	75	47	47	55	55	60~65	SKG25-18HGE	1.7	1	SK25	
	- 90		90	61	61			60~70	SKG25-18HGD	1.8			
	-120		120	91	91			60~70	SKG25-24HG	2.0			

2LOCK SLIM CHUCK

NIKKEN



NEW SKT13 SKT20 Series Addition



SK

Photo shows SK16 type.

Centre Through
MAX. 7MPa

2LOCK tooling (NBT) can be used as the double face contact tooling on the M/C where spindle is BT double face contact system.
2LOCK tooling can also be used on the M/C with BT standard spindle.

When SK J type nut is used, the total chuck length will be extended by 6mm.

PAT.

TAPER	Code No.	D	L	l	l ₁	C	C ₁	H	G No. (Option)	Weight (kg)	Fig	Collet
No.50	NBT50-SK 6C-105	0.7 ~ 6.0	105	55	64	19.5	32	26~31	SKG 6- 6HG	3.8	2	SK 6
	-135		135	60	92					3.9		
	-165		165	114	4.0							
	-200		200	151	4.2							
	-SK10C-105	1.75~10.0	105	57	57	27.5	36	33~41	SKG10-10HG	4.2	3	SK10
	-135		135	70	92					4.4		
	-165		165	114	4.6							
	-200		200	151	4.8							
	-225		225	75	178					5.0		
	-250		250	207	5.2							
	-SK13C-105	2.75~13.0	105	62	62	33	45	39~51	SKG13-10HG	4.5	1	SK13
	-135		135	92	92					4.7		
	-165		165	122	4.9							
	-200		200	157	5.2							
	-250		250	207	5.7							
	-300		300	257	6.7							
	-SK16C-105	2.75~16.0	105	62	62	40	50	45~57	SKG16-12HG	4.7	1	SK16
	-135		135	92	92					4.9		
	-165		165	122	5.1							
	-200		200	157	5.5							
	-250		250	207	6.2							
	-300		300	257	6.7							
	-SK20C-105	3.5~20.0	105	62	62	48.5	48.5	47~63	SKG20-18HG	4.3	1	SK20
	-135		135	92	92					4.6		
-165	165		122	122	5.0							
-200	200		157	157	5.4							
-250	250		207	207	6.2							
-300	300		257	257	7.0							
-SK25C-105	7.5~25.4	105	62	62	55	55	60~70	SKG25-24HG	5.2	1	SK25	
-135		135	92	92					5.4			
-165		165	122	122					5.6			
200		200	157	157					6.0			
-250		250	207	207					6.8			
-300		300	257	257					7.5			

★Please refer P.57 for use as Tap Holder for Synchronized Tapping.



★Please refer P.167 for SK collet.

★Collet, adjust screw (G No.) and spanner are available as an option.

The Code No. of the spanner is SK6 (C=φ18): SKL-6W, SK10: SKL-10, SK13: 9HC12A, SK16: 9HC16, SK20: 9HC22, SK25: 9HC25

★Please refer P.165, P.166 for High Speed Slim Chuck (40,000min⁻¹)

★All Slim Chucks can be used for Centre Through Coolant type. Please refer P.44 for Centre Through Coolant Adjust Screw and P.240 for Centre Through Pull Stud.

★Please refer P.105 for High Pressure (MAX.7MPa) Centre Through Coolant type.

★Please refer P.108 for Flange Through Coolant type.

★NBT40-SK10-200, 250 NBT50-SK10-250, 300 are also available as semi-standard.

-SK16-200, 250 -SK16-250, 300

★Please add "-RP" at the end of Code No. for Rust Proof Treatment Slim Chuck. e.g. NBT40-SK10-90-RP

★Extended gauge length slim chucks with the straight arbor like as Fig.1 are available.

NBT50-SK10C-200ST, -250ST, -300ST

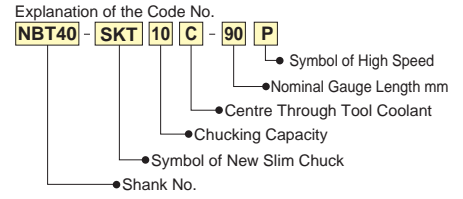
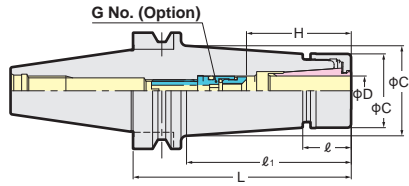
-SK13C-200ST, -250ST, -300ST

-SK16C-200ST, -250ST, -300ST

2LOCK HIGH SPEED SLIM CHUCK (TAPER TYPE)



MAX.40,000min⁻¹ & G2.5



SKT-P

Centre Through
MAX. 7MPa

2LOCK tooling (NBT) can be used as the double face contact tooling on the M/C where spindle is BT double face contact system.
2LOCK tooling can also be used on the M/C with BT standard spindle.

When SK J type nut is used, the total chuck length will be extended by 6mm.

JAPAN, USA PAT.

TAPER	Code No.	D	L	ℓ	ℓ ₁	C	C ₁	H	G No. (Option)	MAX. min ⁻¹	Collet	Weight (kg)						
No.30	NBT30-SKT 6C- 60P	0.7~6.0	60	19.8	35	19.5	21.7	26~31	SKG6-6HG	40,000	SK 6	0.7						
	- 75P				50							23.8	0.7					
	- 90P				65							25.9	0.7					
	-SKT10C- 60P	1.75~10.0	60	22	35	27.5	31.5	35~41	SKG10-10HG		30,000	SK10	0.9					
	- 75P				50								33.6	1.0				
	- 90P				65								36.4	1.0				
	-SKT13C- 60P	2.75~13.0	75	26	35	33	36.4	39~51	SKG13-10HG			25,000	SK13	1.0				
	- 75P				50									38.5	1.1			
	- 90P				65									41.4	1.1			
	-SKT16C- 60P	2.75~16.0	60	27	37	40	43.6	45~52	SKG16-12HGE				20,000	SK16	1.1			
	- 75P				52.6										45~52	1.2		
	- 90P				62.8										45~57	1.2		
No.40	NBT40-SKT 6C- 60P	0.7~6.0	60	19.8	30	19.5	21.0	26~31	SKG6-6HG	30,000				SK 6	1.0			
	- 75P				45										23.1	1.1		
	- 90P				60										25.2	1.1		
	-SKT10C- 60P	1.75~10.0	60	22	30	27.5	32.9	35~41	SKG10-10HG		25,000			SK10	1.4			
	- 75P				45										30.8	1.1		
	- 90P				60										37.1	1.2		
	-SKT13C- 60P	2.75~13.0	60	26	30	33	37.8	39~51	SKG13-10HG			20,000		SK13	1.4			
	- 75P				45										41.3	1.6		
	- 90P				60										44.7	1.3		
	-SKT16C- 60P	2.75~16.0	60	27	30	40	48.5	45~52	SKG16-10HG				15,000	SK16	1.3			
	- 75P				45										50.9	1.5		
	- 90P				60										53.0	1.7		
	-SKT20C- 60P	3.5~20.0	60	28.5	30	48.5	53.0	57~63	SKG20-16HG					15,000	SK20	1.9		
	- 75P				45											57.4	1.3	
	- 90P				60											60.6	1.6	
	-SKT25C- 75P	7.5~25.4	75	31	47	55	57.3	60~65	SKG25-18HGE		15,000				SK25	2.0		
	- 90P				62.6											59.5	1.7	
	-SKT25C- 90P				90											67.8	1.8	
	No.50	NBT50-SKT 6C-105P	0.7~6.0	105	19.8	62	19.5	25.5	26~31			SKG6-6HG			20,000	SK 6	3.8	
		-135P				92											29.6	3.9
		-165P				122											33.8	4.0
		-SKT10C-105P	1.75~10.0	105	22	62	27.5	37.3	35~41			SKG10-10HG	20,000			SK10	4.2	
		-135P				92											41.5	4.4
		-165P				122											45.1	4.6
-SKT13C-105P		2.75~13.0	105	26	62	33	42.3	39~51	SKG13-10HG	15,000		SK13		4.5				
-135P					92									46.5		4.7		
-165P					122									49.1		4.9		
-SKT16C-105P		2.75~16.0	105	27	62	40	49.1	45~57	SKG16-12HG		15,000	SK16		4.7				
-135P					92									53.3		4.9		
-165P					122									57.4		5.1		
-SKT20C-105P		3.5~20.0	105	28.5	62	48.5	57.4	47~63	SKG20-18HG			15,000		SK20		4.3		
-135P					92											61.6	4.6	
-165P					122											66.6	5.0	
-SKT25C-105P		7.5~25.4	105	31	62	55	59.4	60~70	SKG25-24HG				15,000	SK25		5.2		
-135P					92											63.6	5.4	
-165P					122											67.8	5.6	

★Please refer P.43 for TiN Bearing Nut. ★Please add "RP" at the end of the Code No. for Rust Proof Treatment Slim Chuck. e.g. NBT40-SKT10C-90P-RP
 ★Collet, adjust screw(G No.)and GH Handle are available as an option. ★Please use MDSK J type nut & cap for the Centre through tool coolant. P.43
 The Code No. of the GH Handle is SKT6C-P: GH6, SKT10C-P: GH10, SKT13C-P: GH13, SKT16C-P: GH16, SKT20C-P: GH20, SKT25C-P: GH25
 ★P class or A type SK collet is highly recommended to use. P.167



GH Handle
P.30

2LOCK

2LOCK HIGH SPEED SLIM CHUCK (STRAIGHT TYPE)

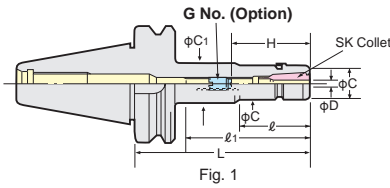


MAX.40,000min⁻¹ & G2.5



SK-P

Centre Through
MAX. 7MPa



Explanation of the Code No.

NBT40 - **GSK** **10** - **90** **P**

- Symbol of High Speed
- Nominal Gauge Length mm
- Chucking Capacity
- Symbol of New Slim Chuck
- Shank No.

2LOCK tooling (NBT) can be used as the double face contact tooling on the M/C where spindle is BT double face contact system.
2LOCK tooling can also be used on the M/C with BT standard spindle.

When SK J type nut is used, the total chuck length will be extended by 6mm.

JAPAN, USA PAT.

TAPER	Code No.	D	L	ℓ	ℓ ₁	C	C ₁	H	G No. (Option)	MAX. min ⁻¹	Collet	Weight (kg)	
No.30	NBT30-SK 6C- 60P	0.7 ~ 6.0	60	33	33	19.5	19.5	26~31	SKG 6- 6HG	40,000	SK 6	0.7	
	- 90P		90	56	65		32					0.7	
	-SK10C- 45P	1.75~10.0	45	22	22	27.5	27.5	33~41	SKG10-10HG		SK10	0.8	
	- 60P		60	35	35							0.9	
	- 75P		75	50	50							1.0	
	- 90P		90	65	65							1.0	
	-SK13C- 60P	2.75~13.0	60	35	35	33	33	39~51	SKG13-10HG		SK13	1.0	
	- 75P		75	50	50							1.1	
	- 90P		90	65	65							1.1	
	-SK16C- 60P	2.75~16.0	60	37	37	40	40	47~52	SKG16-12HGE		SK16	1.1	
	- 75P		75	52	52			45~52				1.2	
	- 90P		90	67	67			45~57				1.2	
-SK20 - 60P*	3.5~20.0	60	37	37	48.5	48.5	65~70	SKG-12S	SK20	0.7			
-SK20C- 75P		75	52	52			50~55			0.9			
- 90P		90	67	67			47~63			1.2			
-SK25 - 90P*	7.5~25.4	90	67	67	55	55	55~75	SKG-12	SK25	1.5			
No.40	NBT40-SK 6C- 60P	0.7 ~ 6.0	60	30	30	19.5	19.5	26~31	SKG 6- 6HG	30,000	SK 6	1.0	
	- 90P		90	51	60		32					1.1	
	-120P	120	60	90	27.5	40	33~41	SKG10-10HG	SK10		1.4		
	-SK10C- 60P	1.75~10.0	60	32							32	1.1	
	- 75P		75	45							45	1.2	
	- 90P		90	48							60	1.2	
	-120P		120	90	90	1.4							
	-150P	150	73	118	34.5	1.6							
	-SK13C- 60P	2.75~13.0	60	28	28	33	33	39~51	SKG13-10HG		SK13	1.2	
	- 75P		75	43	43							1.3	
	- 90P		90	58	58							1.4	
	-120P		120	88	88							1.6	
	-150P	150	118	118	40	1.8							
	-SK16C- 60P	2.75~16.0	60	32	32	40	40	45~52	SKG16-10HG		SK16	1.3	
	- 75P		75	43	43			1.5					
	- 90P		90	58	58			45~57				1.5	
	-120P		120	88	88			1.7					
	-150P	150	118	118	25,000	1.9							
	-SK20C- 60P	3.5~20.0	60	32	32	48.5	48.5	57~63	SKG20-16HG		SK20	1.3	
	- 75P		75	45	45			1.4					
	- 90P		90	60	60			47~63				1.6	
	-120P		120	90	90			2.0					
	-SK25C- 75P	7.5~25.4	75	47	47	55	55	60~65	SKG25-18HGE		SK25	1.7	
	- 90P		90	61	61			SKG25-18HGD				1.8	
-120P	120		91	91	60~70			2.0					
-150P	150		122	122	20,000			2.0					
No.50	NBT50-SK 6C-105P	0.7 ~ 6.0	105	55	64	19.5	32	26~31	SKG 6- 6HG	20,000	SK 6	3.8	
	-135P		135	60	92							3.9	
	-165P		165	114	114							4.0	
	-SK10C-105P	1.75~10.0	105	57	57	27.5	27.5	33~41	SKG10-10HG		SK10	4.2	
	-135P		135	70	92							4.4	
	-165P		165	75	114							32	4.6
	-SK13C-105P		2.75~13.0	105	62							62	33
	-135P	135		92	92	45	4.7						
	-165P	165		122	122	4.9							
	-SK16C-105P	2.75~16.0	105	62	62	40	40	45~57	SKG16-12HG		SK16	4.7	
	-135P		135	92	92							50	4.9
	-165P		165	90	122							15,000	5.1
	-SK20C-105P	3.5~20.0	105	62	62	48.5	48.5	47~63	SKG20-18HG		SK20	4.3	
	-135P		135	92	92							4.6	
	-165P		165	122	122							5.0	
	-SK25C-105P		7.5~25.4	105	62							62	55
	-135P	135		92	92	5.4							
	-165P	165		122	122	5.6							

*Please refer P.43 for TiN Bearing Nut.

*Please add "RP" at the end of the Code No. for Rust Proof Treatment Slim Chuck. e.g. NBT40-SKT10C-90P-RP

*Collet, adjust screw(G No.)and GH Handle are available as an option.

*Please use MDSK J type nut & cap for the Centre through tool coolant. P.43

The Code No. of the GH Handle is SK6C-P: GH6, SK10C-P: GH10, SK13C-P: GH13, SK16C-P: GH16, SK20C-P: GH20, SK25C-P: GH25

*P class or A type SK collet is highly recommended to use. P.167

*Code No. marked * are not centre coolant tool coolant type.

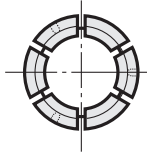
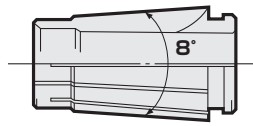


GH Handle
P.30

2LOCK

SLIM CHUCK COLLET

NIKKEN



Explanation of the Code No.

SK 10 - 6 P

- Non: Standard
- P: P class (Run-out Accuracy=3μm)
- A: A type (for End Mill Shank)
- MAX. Chucking Dia.
- Style No.
- Symbol of SK Collet

SK "A" type SK collet (for End Mill Shank) are marked **P**. The acceptable shank tolerance is h8. Code No. is e.g. SK10-10A
 "P" class SK collet (for drill) are available for all series. e.g. SK10-10P

Code No.	Chucking D
SK 6- 0.8	0.7 ~ 0.8
- 1	0.9 ~ 1.0
- 1.25	1.15 ~ 1.25
- 1.5	1.3 ~ 1.5
- 1.75	1.55 ~ 1.75
- 2	1.8 ~ 2.0
- 2.25	2.05 ~ 2.25
- 2.5	2.3 ~ 2.5
- 2.75	2.55 ~ 2.75
- 3	2.8 ~ 3.0
- 3.5	3.0 ~ 3.5
- 4	3.5 ~ 4.0
- 4.5	4.0 ~ 4.5
- 5	4.5 ~ 5.0
- 5.5	5.0 ~ 5.5
- 6	5.5 ~ 6.0
SK10- 2	1.75 ~ 2.0
- 2.25	2.0 ~ 2.25
- 2.5	2.25 ~ 2.5
- 2.75	2.5 ~ 2.75
- 3	2.75 ~ 3.0
- 3.5	3.0 ~ 3.5
- 4	3.5 ~ 4.0
- 4.5	4.0 ~ 4.5
- 5	4.5 ~ 5.0
- 5.5	5.0 ~ 5.5
- 6	5.5 ~ 6.0
- 6.5	6.0 ~ 6.5
- 7	6.5 ~ 7.0
- 7.5	7.0 ~ 7.5
- 8	7.5 ~ 8.0
- 8.5	8.0 ~ 8.5
- 9	8.5 ~ 9.0
- 9.5	9.0 ~ 9.5
- 10	9.5 ~ 10.0

Code No.	Chucking D
SK13- 3	2.75 ~ 3.0
- 3.5	3.0 ~ 3.5
- 4	3.5 ~ 4.0
- 4.5	4.0 ~ 4.5
- 5	4.5 ~ 5.0
- 5.5	5.0 ~ 5.5
- 6	5.5 ~ 6.0
- 6.5	6.0 ~ 6.5
- 7	6.5 ~ 7.0
- 7.5	7.0 ~ 7.5
- 8	7.5 ~ 8.0
- 8.5	8.0 ~ 8.5
- 9	8.5 ~ 9.0
- 9.5	9.0 ~ 9.5
- 10	9.5 ~ 10.0
- 10.5	10.0 ~ 10.5
- 11	10.5 ~ 11.0
- 11.5	11.0 ~ 11.5
- 12	11.5 ~ 12.0
- 12.5	12.0 ~ 12.5
- 13	12.5 ~ 13.0

Code No.	Chucking D
SK16- 3	2.75 ~ 3.0
- 3.5	3.0 ~ 3.5
- 4	3.5 ~ 4.0
- 4.5	4.0 ~ 4.5
- 5	4.5 ~ 5.0
- 5.5	5.0 ~ 5.5
- 6	5.5 ~ 6.0
- 6.5	6.0 ~ 6.5
- 7	6.5 ~ 7.0
- 7.5	7.0 ~ 7.5
- 8	7.5 ~ 8.0
- 8.5	8.0 ~ 8.5
- 9	8.5 ~ 9.0
- 9.5	9.0 ~ 9.5
- 10	9.5 ~ 10.0
- 10.5	10.0 ~ 10.5
- 11	10.5 ~ 11.0
- 11.5	11.0 ~ 11.5
- 12	11.5 ~ 12.0
- 12.5	12.0 ~ 12.5
- 13	12.5 ~ 13.0
- 13.5	13.0 ~ 13.5
- 14	13.5 ~ 14.0
- 14.5	14.0 ~ 14.5
- 15	14.5 ~ 15.0
- 15.5	15.0 ~ 15.5
- 16	15.5 ~ 16.0

Code No.	Chucking D
SK20- 4	3.5 ~ 4.0
- 4.5	4.0 ~ 4.5
- 5	4.5 ~ 5.0
- 5.5	5.0 ~ 5.5
- 6	5.5 ~ 6.0
- 6.5	6.0 ~ 6.5
- 7	6.5 ~ 7.0
- 7.5	7.0 ~ 7.5
- 8	7.5 ~ 8.0
- 8.5	8.0 ~ 8.5
- 9	8.5 ~ 9.0
- 9.5	9.0 ~ 9.5
- 10	9.5 ~ 10.0
- 10.5	10.0 ~ 10.5
- 11	10.5 ~ 11.0
- 11.5	11.0 ~ 11.5
- 12	11.5 ~ 12.0
- 12.5	12.0 ~ 12.5
- 13	12.5 ~ 13.0
- 13.5	13.0 ~ 13.5
- 14	13.5 ~ 14.0
- 14.5	14.0 ~ 14.5
- 15	14.5 ~ 15.0
- 15.5	15.0 ~ 15.5
- 16	15.5 ~ 16.0
- 16.5	16.0 ~ 16.5
- 17	16.5 ~ 17.0
- 17.5	17.0 ~ 17.5
- 18	17.5 ~ 18.0
- 18.5	18.0 ~ 18.5
- 19	18.5 ~ 19.0
- 19.5	19.0 ~ 19.5
- 20	19.5 ~ 20.0

Code No.	Chucking D
SK25- 8	7.5 ~ 8.0
- 10	9.5 ~ 10.0
- 12	11.5 ~ 12.0
- 16	15.5 ~ 16.0
- 16.5	16.0 ~ 16.5
- 17	16.5 ~ 17.0
- 17.5	17.0 ~ 17.5
- 18	17.5 ~ 18.0
- 18.5	18.0 ~ 18.5
- 19	18.5 ~ 19.0
- 19.5	19.0 ~ 19.5
- 20	19.5 ~ 20.0
- 20.5	20.0 ~ 20.5
- 21	20.5 ~ 21.0
- 21.5	21.0 ~ 21.5
- 22	21.5 ~ 22.0
- 22.5	22.0 ~ 22.5
- 23	22.5 ~ 23.0
- 23.5	23.0 ~ 23.5
- 24	23.5 ~ 24.0
- 24.5	24.0 ~ 24.5
- 25	24.5 ~ 25.0
- 25.4	25.0 ~ 25.4

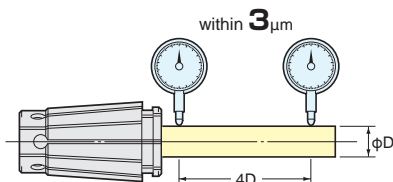
★SK6 collet with the special internal dia. is also available.



Collet removal (SKR-6) is supplied as standard only for SK6. SKR-10, SKR-16 and SKR-25 are available as an option. Collet removal is not necessary for the new types of collet (SK10 to SK25 collet including SK13 and SK20).

"P" class SK collet for drill

It guarantees the Run-out accuracy within 3 micron at the nose (4D) from the chuck. Additionally Collet Set is also available.



"A" type SK collet for endmill

The acceptable shank tolerance is h8.

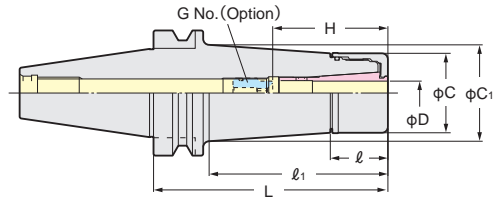
SK Collet A type
SK 6-3A, 3.175A, 4A, 5A, 6A
SK10-3A, 3.175A, 4A, 5A, 6A, 8A, 10A
SK13-3A, 4A, 5A, 6A, 8A, 10A, 12A
SK16-3A, 4A, 5A, 6A, 8A, 10A, 12A, 16A
SK20-4A, 5A, 6A, 8A, 10A, 12A, 16A, 20A
SK25-8A, 10A, 12A, 16A, 20A, 25A

2LOCK ANNIVERSARY TYPE VC HOLDER

NIKKEN



With TiN Bearing Nut
 MAX. 40,000min⁻¹ & G2.5
 Run-Out Accuracy : Within 3µm at 4D



VC

Centre Through
 MAX. 7MPa

2LOCK tooling (NBT) can be used as the double face contact tooling on the M/C where spindle is BT double face contact system.
2LOCK tooling can also be used on the M/C with BT standard spindle.

High Speed

PAT.

TAPER	Code No.	D	L	ℓ	ℓ ₁	C	C ₁	H	G No. (Option)	Weight (kg)	MAX. min ⁻¹	Collet	
No.30	NBT30-VC 6- 45	2.0~ 6.0	45	23	23	27.5	27.5	35~45	VCG 6- 8A	0.5	40,000	VCK 6	
	- 60		60		35		31.7			0.6			
	- 90		90		65		33.4			0.8			
	-VC13- 60	3.0~12.0	60	29	37	40	41.1	50~60	VCG13-15A	0.7			
			- 90		90		67			41.3			0.9
			-120		120		97			42.4			1.2
No.40	NBT40-VC 6- 60	2.0~ 6.0	60	23	30	27.5	30.0	35~45	VCG 6- 8A	1.1	30,000	VCK 6	
	- 90		90		60		32.7			1.3			
	-120		120		90		36.9			1.5			
	-VC13- 60	3.0~12.0	60	29	31	40	40.3	50~60	VCG13-15A	1.2			
			- 90		90		60			44.3			1.5
			-120		120		90			48.5			1.9
No.50	NBT50-VC 6-105	2.0~ 6.0	105	23	62	27.5	33.0	35~45	VCG 6- 8A	3.9	20,000	VCK 6	
	-135		135		92		37.1			4.1			
	-165		165		122		41.3			4.4			
	-VC13-105	3.0~12.0	105	29	62	40	44.6	50~60	VCG13-15A	4.1			
			-135		135		92			48.8			4.5
			-165		165		122			53.0			4.9

★TiN Bearing Nut is supplied as standard.

★Collet, Adjust Screw (G No.) and GH Handle are available as an option.

★Please add "-RP" at the end of Code No. for Rust Proof Treatment VC Holder. e.g:NBT40-VC13-60-RP

★Please use VC J type Nut & Cap for Centre Through Coolant. When VC J type Nut is used, the total holder length will be extended to 6mm.

★NBT40-VC 6-150, NBT40-VC13-150, NBT50-VC13- 90, -120 are available as semi-standard.

★When the axial stopper is required, please use Adjust Screw (G No.)

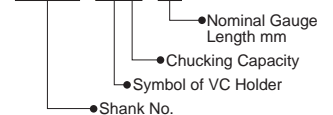
★All series are for High Speed Rotation.



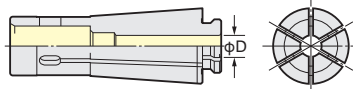
GH Handle P.30

Explanation of the Code No.

NBT40 - VC6 - 90



VCK Collet



VCK Collet Code No.

VCK 6-2, 3, (3.175), 4, 5, 6

VCK13-3, (3.175), 4, 5, 6, 7, 8, 9, 10, 11, 12

★The acceptable shank tolerance of VCK collet is h₈.

★Inch series is also available.

VCK 6-1/8, 3/16, 1/4 VCK13-1/8, 3/16, 1/4, 5/16, 3/8, 7/16, 1/2

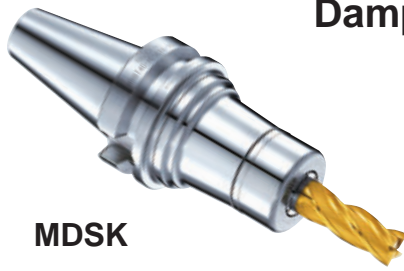
★VCK 6-3.175 is same as VCK 6-1/8.

★VCK13-3.175 is same as VCK13-1/8.

2LOCK

Holder with an adjust screw for axial adjustment is supplied as an option. Please contact us.

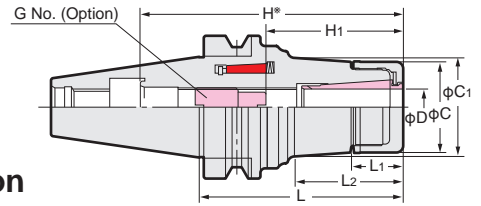
**Dampening Effect
TiN Bearing Effect**



MDSK

NEW

**MDSK6 Series Addition
MDSK13**



H : MAX. Cutter Shank Length to be inserted

2LOCK tool can be used on the M/C with BT standard spindle.

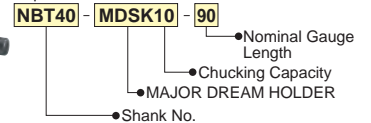
PAT.

TAPER	Code No.	D	L	L1	L2	C	C1	H*	H1	G No. (Option)	Weight (kg)	Collet
No.30	NBT30-MDSK 6- 50	3.0~6.0	50	16.2	19.5	19.5	20.0	73	21~35	SKG- 8	0.5	SK 6 A
	- 60		60		25.5		83	0.6				
	- 75		75		40.5		98	0.7				
	- 90		90		55.5		113	0.8				
	-MDSK10- 50	3.0~10.0	50	18.0	19.0	27.5	27.5	72	30~50	SKG-12L	0.5	SK10 A
	- 60		60		25.7		82	0.6				
	- 75		75		42.9		97	0.8				
	- 90		90		58.7		112	0.8				
	-MDSK13- 60	3.0~13.0	60	22.0	29.0	33.0	34.0	83	31~43	SKG-15	0.8	SK13 A
	- 75		75		45.0		98	0.8				
	- 90		90		60.0		113	0.8				
	-MDSK16- 75	3.0~16.0	75	23.0	47.5	40.0	60	75	45~60	SKG-12L	1.1	SK16 A
- 90	90		62.5		40.0		75	45~70	SKG-12	1.3		
No.40	NBT40-MDSK 6- 60	3.0~6.0	60	16.2	18.0	19.5	19.5	86	21~35	SKG- 8	0.8	SK 6 A
	- 75		75		33.0		101	0.9				
	- 90		90		48.0		116	1.1				
	-105		105		63.0		131	1.2				
	-120	120	78.0	146	1.4							
	-MDSK10- 60	3.0~10.0	60	18.0	19.0	27.5	27.5	86	30~50	SKG-12L	1.1	SK10 A
	- 75		75		33.0		101	1.3				
	- 90		90		48.0		116	1.5				
	-105		105		63.0		131	1.6				
	-120	120	78.0	146	1.8							
	-150	150	110.0	176	2.2							
	-MDSK13- 65	3.0~13.0	65	22.0	24.0	33.0	33.0	91	31~60	SKG-15	1.2	SK13 A
	- 75		75		33.0		101	1.4				
	- 90		90		48.0		116	1.7				
	-105		105		63.0		131	1.8				
	-120	120	78.0	146	2.0							
	-150	150	110.0	176	2.4							
	-180	180	144.0	206	2.6							
	-MDSK16- 65	3.0~16.0	65	23.0	24.0	40.0	40.0	91	45~60	SKG-18L	1.2	SK16 A
	- 75		75		33.0		101	1.5				
	- 90		90		48.0		116	1.9				
	-105		105		64.0		131	2.0				
	-120	120	80.0	146	2.2							
	-150	150	113.0	176	2.5							
-MDSK20- 75	4.0~20.0	75	25.2	41.2	48.0	51.3	80	50~73	SKG-12	1.9	SK20 A	
- 90		90		55.0		95	SKG-12-55L		2.1			
-105		105		70.0		110	SKG-12-70L		2.3			
-120		120		85.0		125	SKG-12-85L		2.6			

- ★Please use A type SK collet for the end milling operation. (P.170)
- ★Please refer P.43, P.44 for the Jet coolant system, J type nut and cap.
- ★GH handle is available as an option. (P.30) Please order with the Code No. GH6 : MDSK6 &, GH10 : MDSK10, GH16 : MDSK16, GH20 : MDSK20, GH25 : MDSK25
- ★Please add "P" at the end of Code No. for high speed specification, e.g NBT40-MDSK10-60P
- ★Holder with an adjust screw for axial adjustment is supplied as an option. Please contact us.



Explanation of the Code No.

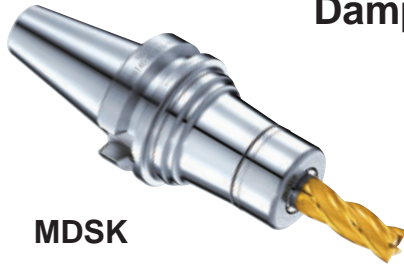


MAX. min⁻¹

Code No.	MAX. min ⁻¹	Code No.	MAX. min ⁻¹	Code No.	MAX. min ⁻¹
NBT30-MDSK 6-P	30,000	NBT40-MDSK 6-P	25,000	NBT50-MDSK 6-P	20,000
-MDSK10-P		-MDSK10-P		-MDSK10-P	
-MDSK13-P		-MDSK13-P		-MDSK13-P	
-MDSK16-P	25,000	-MDSK16-P	20,000	-MDSK16-P	
		-MDSK20-P		-MDSK20-P	
				-MDSK25-P	

Holder with an adjust screw for axial adjustment is supplied as an option. Please contact us.

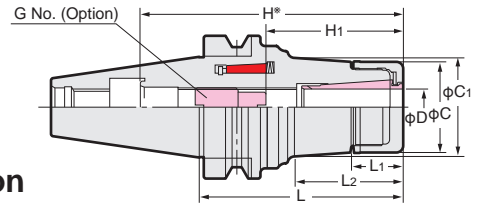
Dampening Effect
TiN Bearing Effect



MDSK

NEW

MDSK6 Series Addition
MDSK13



H : MAX. Cutter Shank Length to be inserted

2LOCK tool can be used on the M/C with BT standard spindle.

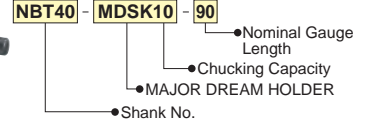
PAT.

TAPER	Code No.	D	L	L1	L2	C	C1	H*	H1	G No. (Option)	Weight (kg)	Collet	
No.50	NBT50-MDSK 6-105	3.0~6.0	105	16.2	48.0	19.5	24.0	116	21~35	SKG- 8	3.6	SK 6 A	
	-120		120		63.0		26.1				131		3.7
	-MDSK10-105	3.0~10.0	105	18.2	48.0	27.5	31.7	116	30~50	SKG-12L	4.3	SK10 A	
	-120		120		63.2		33.8				131		4.4
	-135		135		78.2		35.9				146		4.7
	-165		165		110.2		40.4				176		5.0
	-195	195	141.2	44.8	206	5.3							
	-MDSK13-105	3.0~13.0	105	22.0	48.0	33.0	36.7	116	31~60	SKG-15	4.2	SK13 A	
	-120		120		63.0		38.8				131		4.7
	-135		135		78.0		40.9				146		5.0
	-165		165		110.0		45.4				176		5.3
	-195		195		144.0		50.1				206		5.6
	-MDSK16-105	3.0~16.0	105	23.0	48.0	40.0	43.5	116	45~70	SKG-18L	4.1	SK16 A	
	-120		120		64.0		45.8				131		4.9
	-135		135		80.1		48.0				146		5.2
	-165		165		114.7		52.6				176		5.5
	-195		195		144.6		52.8				206		5.8
	-MDSK20-105	4.0~20.0	105	25.2	42.3	48.0	51.4	159	47~80	SKG-22	4.9	SK20 A	
	-135		135		72.0		55.6				175		5.3
	-165		165		102.0		59.8				205		5.9
	-195		195		132.0		64.0				235		6.7
	-MDSK25-105	8.0~25.4	105	27.0	42.3	55.0	57.2	159	55~85	SKG-28	4.9	SK25 A	
	-135		135		74.0		61.6				175		5.7
	-165		165		105.0		66.0				205		6.5
-195	195		135.0		70.2		235				7.5		

- ★Please use A type SK collet for the end milling operation. (P.170)
- ★Please refer P.43, P.44 for the Jet coolant system, J type nut and cap.
- ★GH handle is available as an option. (P.30) Please order with the Code No. GH6 : MDSK6 &, GH10 : MDSK10, GH16 : MDSK16, GH20 : MDSK20, GH25 : MDSK25
- ★Please add "P" at the end of Code No. for high speed specification, e.g NBT40-MDSK10-60P
- ★Holder with an adjust screw for axial adjustment is supplied as an option. Please contact us.



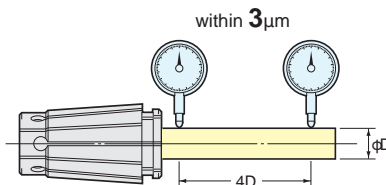
Explanation of the Code No.



A TYPE SLIM COLLET

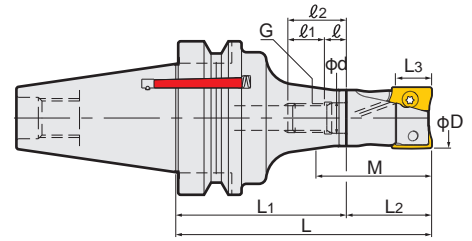
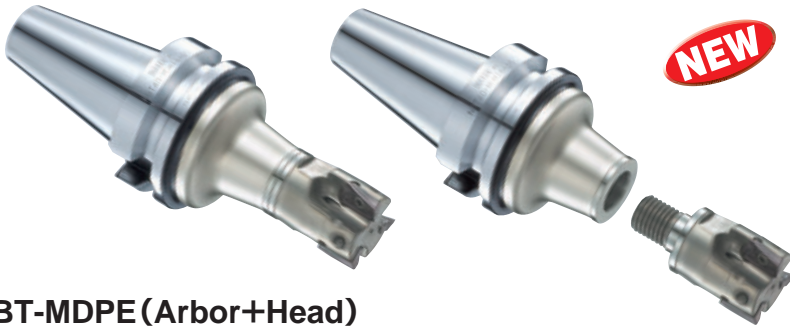


SK



SK Collet A Type
SK 6-3A, 3.175A, 4A, 5A, 6A
SK10-3A, 3.175A, 4A, 5A, 6A, 8A, 10A
SK13-3A, 4A, 5A, 6A, 8A, 10A, 12A
SK16-3A, 4A, 5A, 6A, 8A, 10A, 12A, 16A
SK20-4A, 5A, 6A, 8A, 10A, 12A, 16A, 20A
SK25-8A, 10A, 12A, 16A, 20A, 25A

★The acceptable shank tolerance of A Type collet is h8.



NBT-MDPE (Arbor+Head)

TAPER	Code No.	φD	L	L1	L2	MAX. Depth L3	M	Arbor Code No.	Head Code No.
No.30	NBT30-MDPE16- 75	16	75	45	30	10	37.5	NBT30-MDPE-M 8- 45	M 8-MDPE16-30
	-MDPE20- 75	20						-MDPE-M10- 45	M10-MDPE20-30
	-MDPE25- 80	25	80	35	15	43.4	-MDPE-M12- 45	M12-MDPE25-35	
	-MDPE32- 95	32	95	55	40	52.5	-MDPE-M16- 55	M16-MDPE32-40	
No.40	NBT40-MDPE16- 85,105,120	16	85,105,120	55, 75, 90	30	10	37.4	NBT40-MDPE-M 8- 55, 75, 90	M 8-MDPE16-30
	(NIT40)-MDPE20- 90,105,120	20	90,105,120	60, 75, 90				40.0	-MDPE-M10- 60, 75, 90
	-MDPE25- 90,105,120	25	90,105,120	55, 70, 85	35	15	45.3,47.5,47.5	-MDPE-M12- 55, 70, 85	M12-MDPE25-35
	-MDPE32-105,120,135	32	105,120,135	65, 80, 95	40	52.5	-MDPE-M16- 65, 80, 95	M16-MDPE32-40	
No.50	NBT50-MDPE16-100,120,135	16	100,120,135	70, 90,105	30	10	37.4	NBT50-MDPE-M 8- 70, 90,105	M 8-MDPE16-30
	(NIT50)-MDPE20-105,120,135	20	105,120,135	75, 90,105				40.0	-MDPE-M10- 75, 90,105
	-MDPE25-105,120,135	25	105,120,135	70, 85,100	35	15	45.3,47.5,47.5	-MDPE-M12- 70, 85,100	M12-MDPE25-35
	-MDPE32-120,135,150	32	120,135,150	80, 95,110	40	52.5	-MDPE-M16- 80, 95,110	M16-MDPE32-40	

★2pcs of tip clamp bolt and tip clamp wrench are supplied as standard.
★Insert tip is available as an option . Please refer P.171.
★Centre through tool coolant is available for all series.

★Please refer P.219 for cutting condition.

NBT-MDPE-M (Arbor)

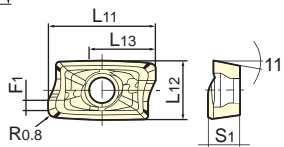
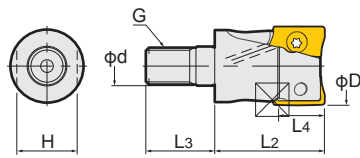
TAPER	Code No.	φD	L1	ID φd	Arbor Front Dia.	ℓ	ℓ1	ℓ2	Screw G
No.30	NBT30-MDPE-M 8- 45	16	45	8.5	14.7	9	11	20	M 8
	-MDPE-M10- 45	20		10.5	18.7		12	21	M10
	-MDPE-M12- 45	25		12.5	23.0		15	24	M12
	-MDPE-M16- 55	32		17.0	30.0		16	25	M16
No.40	NBT40-MDPE-M 8- 55, 75, 90	16	55, 75, 90	8.5	14.7		11	20	M 8
	(NIT40)-MDPE-M10- 60, 75, 90	20	60, 75, 90	10.5	18.7		12	21	M10
	-MDPE-M12- 55, 70, 85	25	55, 70, 85	12.5	23.0		15	24	M12
	-MDPE-M16- 65, 80, 95	32	65, 80, 95	17.0	30.0		16	25	M16
No.50	NBT50-MDPE-M 8- 70, 90,105	16	70, 90,105	8.5	14.7		11	20	M 8
	(NIT50)-MDPE-M10- 75, 90,105	20	75, 90,105	10.5	18.7		12	21	M10
	-MDPE-M12- 70, 85,100	25	70, 85,100	12.5	23.0		15	24	M12
	-MDPE-M16- 80, 95,110	32	80, 95,110	17.0	30.0		16	25	M16

★Head is available as an option. P.171

★Centre through tool coolant is available for all series.

★This is interchangeable with DEPO. When the connection interface (Screw G and ID φd) is same, the cutter head of other carbide makers can be used.

INTERCHANGABLE PRO-ENDMILL HEAD



AOMT (Insert Tip)

Insert Tip Code No.	L11	L12	L13	S1	F1
AOMT123608PEER-M	12	6.6	10	3.6	1.2
AOMT184808PEER-M	18	9	15	4.8	1.4

★Only Nose R = 0.8 is available. Please contact Mitsubishi for the rigid type insert tip and the insert tip with other Nose R.
★Only grade of VP15TF (for steel, cast iron, hardened steel) is available. Please contact Mitsubishi for VP20RT (for stainless steel) and TF15 (for aluminum).
★Minimum order quantity: 10pcs.

M-MDPE (Head)

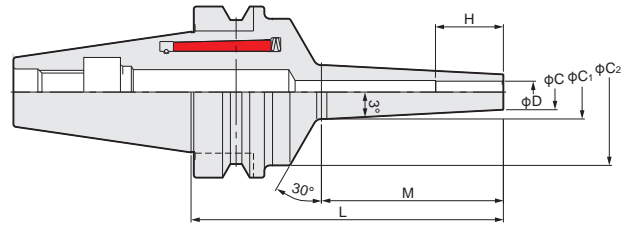
φD	Code No.	L2	L3	MAX. Depth L4	φd	G	No. of Teeth	Insert Tip	Tip Clamp Bolt	Tip Clamp wrench	Spanner Width H
16	M 8-MDPE16-30	30	18	10	8.5	M 8	2	AOMT123608PEER-M	TPS-25	TIP07F	10
20	M10-MDPE20-30		19		10.5	M10	3				14
25	M12-MDPE25-35	35	22	15	12.5	M12	2	AOMT184808PEER-M	TPS-4	TIP15W	19
32	M16-MDPE32-40				23	17.0	M16				3

★2pcs of tip clamp bolt and tip clamp wrench are supplied as standard.
★Insert tip is available as an option . Please refer P.171.
★Centre through tool coolant is available for all series.

★Please refer P.219 for cutting condition.



NEW



S Slim Style

TAPER	Code No.	φD	φC	φC ₁	φC ₂	L	M	H
No.30	NBT30-MDMS 3S- 80, -105	3	6	10.2, 12.8	41	80, 105	42, 67	10
	-MDMS 4S- 80, -105	4	7	11.2, 13.8				13
	-MDMS 6S- 80, -105	6	9	13.2, 15.8		19		
	-MDMS 8S- 80, -105	8	13	17.2, 19.8		25		
	-MDMS10S- 80	10	16	20.2		80	42	31
No.40	NBT40-MDMS 3S- 90, -115	3	6	10.2, 12.8	54	90, 115	42, 67	10
	(NIT40)-MDMS 4S- 90, -115	4	7	11.2, 13.8				13
	-MDMS 6S- 90, -115	6	9	13.2, 15.8				19
	-MDMS 8S- 90, -115	8	13	17.2, 19.8				25
	-MDMS10S- 90, -115	10	16	20.2, 22.8				31
	-MDMS12S- 90, -115	12	19	23.2, 25.8				31
No.50	NBT50-MDMS 3S-130	3	6	12.8	54	130	42, 67	10
	(NIT50)-MDMS 4S-105, -130	4	7	11.2, 13.8		105, 130		13
	-MDMS 6S-105, -130	6	9	13.2, 15.8				19
	-MDMS 8S-105, -130	8	13	17.2, 19.8				25
	-MDMS10S-105, -130	10	16	20.2, 22.8				31
	-MDMS12S-105, -130	12	19	23.2, 25.8				31

R Standard

TAPER	Code No.	φD	φC	φC ₁	φC ₂	L	M	H
No.30	NBT30-MDMS 4R- 80, -105	4	10	14.2, 16.8	41	80, 105	42, 67	13
	-MDMS 6R- 80, -105	6	12	16.2, 18.8				19
	-MDMS 8R- 80, -105	8	18	22.2, 24.8				25
	-MDMS10R- 80, -105	10	22	26.2, 28.8				31
No.40	NBT40-MDMS 4R- 90	4	10	14.2	54	90	42, 67	13
	(NIT40)-MDMS 6R- 90, -115	6	12	16.2, 18.8		90, 115		19
	-MDMS 8R- 90, -115	8	18	22.2, 24.8				25
	-MDMS10R- 90, -115	10	22	26.2, 28.8				31
	-MDMS12R- 90, -115	12	26	30.2, 32.8				31
No.50	NBT50-MDMS 6R-105, -130	6	12	16.2, 18.8	54	105, 130	42, 67	19
	(NIT50)-MDMS 8R-105, -130	8	18	22.2, 24.8				25
	-MDMS10R-105, -130	10	22	26.2, 28.8				31
	-MDMS12R-105, -130	12	26	30.2, 32.8				31

★Please note the acceptable shank tolerance is h6.

★Carbide tool can be used and HSS tool can not be used.

★The tool will become very hot during heat shrinking. Please use glove for safety.

★ID=φ16, φ20 and φ25mm are available.

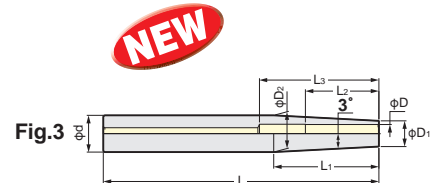
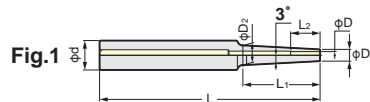
★The capacity of the drier is approx. 3KW.

★Inductive style of the heat shrinking unit is recommended.

STRAIGHT SHANK MASAMUNE SHRINK FIT HOLDER



MS-A



NEW

Style d	Code No.	L	φD	L ₁	L ₂	L ₃	D ₁	D ₂	Fig
10	MS10-A 3- 90	90	3	27	10	—	6	8.7	1
	-A 4- 90		4		13		7	9.7	
16	MS16-A 4-120	120	4	42	13	—	7	11.2	1
	-A 6-120		6		19		10	14.2	
	-A 8-120		8		25		12	16.0	2
20	MS20-A 6-150	150	6	72	19	—	10	17.4	1
	-A 8-150		8		25		12	19.4	
	-A10-150		10		31		14	20.0	3
	-A12-150		12		37		16	20.0	

★Please note the acceptable shank tolerance is h6.

★Carbide tool can be used and HSS tool can not be used.

★Minimum insertion length is L₂.

★Maximum insertion length is L₃. If cutting tool is inserted longer than L₃, the cutting tool bottom will be contacted to holder. Then, the run-out accuracy will be worse.

★The tool will become very hot during heat shrinking. Please use glove for safety.

★ID=φ16, φ20 and φ25mm are available.

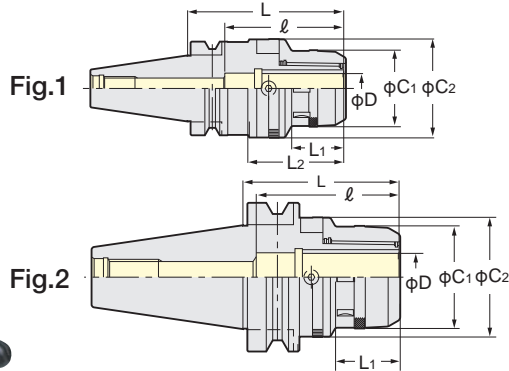
★The capacity of the drier is approx. 3KW.

★Inductive style of the heat shrinking unit is recommended.

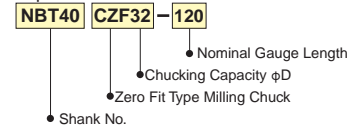
2LOCK NBT ZERO FIT TYPE MILLING CHUCK



NEW



Explanation of the Code No.



MAX. run-out at 100mm	
CZF20	0.050mm / dia.
CZF25	0.050mm / dia.
CZF32	0.030mm / dia.

PAT.

TAPER	Code No.	C ₁	C ₂	L	L ₁	L ₂	ℓ	Weight(Kg)	Fig.	Collet
No.30	NBT30-CZF20-100	51.5	66.5	100	35	68	80	1.5	1	KM20 CCK20
	-CZF25-100	59.5	74.5					1.6		KM25 CCK25
No.40	NBT40-CZF20-105, 120	51.5	66.5	105, 120	35	64.5	80	2.1, 2.5	1	KM20 CCK20
	(NIT40)-CZF25-105, 120	59.5	74.5			68		2.4, 2.9		KM25 CCK25
	-CZF32-120	69	80.5	120	42	78	105	2.8		KM32 CCK32
No.50	NBT50-CZF20-105, 165	51.5	66.5	105, 165	35	-	80	4.6, 6.0	2	KM20 CCK20
	(NIT50)-CZF25-105, 165	59.5	74.5					5.0, 6.8		KM25 CCK25
	-CZF32-105, 165	69	80.5	42	105	5.3, 7.4	KM32 CCK32			

★Please refer ☞ P.31, P.32 for KM, CCK collet.
 ★Spanner is available as an option.
 CZF20 type : 9HC22, CZF25 type : 9HC25, CZF32 type : 9HC32
 ★Wrench to adjust run-out(9ZFL) is available as an option.

★Please note that the acceptable shank tolerance is h₆~h₇.
 ★Please add "P" at the end of Code No. for the high speed type. e.g. MBT40-CZF25-105P



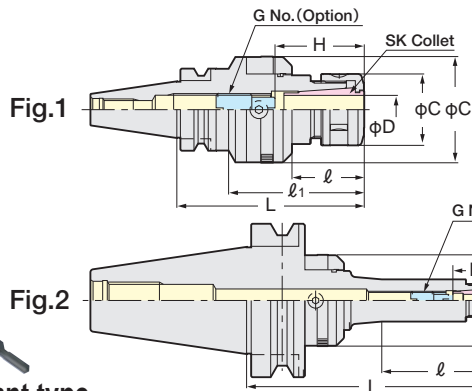
Wrench to adjust
9ZFL

★For How to Adjust the Run-Out, please refer ☞ P.156.

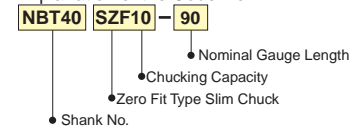
2LOCK NBT ZERO FIT TYPE SLIM CHUCK



NEW



Explanation of the Code No.



MAX. run-out at 100mm		
SZF 6	L < 150	0.050mm / dia.
	L ≥ 150	0.040mm / dia.
SZF10		0.050mm / dia.
SZF16		0.040mm / dia.
SZF25		0.025mm / dia.

PAT.

TAPER	Code No.	D	L	ℓ	ℓ ₁	C	C ₁	H	G No. (Option)	Weight (Kg)	Fig.	Collet
No.30	NBT30-SZF 6C- 90	0.7~6.0	90	42	-	19.5	40.5	26~31	SKG 6- 6HG	0.9	2	SK 6
	-SZF10C- 90	1.75~10.0		35	61	27.5	48.5	35~41	SKG10-10HG	1.3		SK10
	-SZF16C-105	2.75~16.0		105	40	76	40	59.5	45~57	SKG16-12HG		1.6
No.40	NBT40-SZF 6C- 90,150	0.7~6.0	90, 150	37, 60	-	19.5	40.5, 48.5	26~31	SKG 6- 6HG	1.3, 1.7	2	SK 6
	(NIT40)-SZF10C- 90,150	1.75~10.0		37, 97		27.5	48.5	35~41	SKG10-10HG	1.5, 1.9		SK10
	-SZF16C- 90,150	2.75~16.0	40	59.5	45~57	SKG16-12HG	1.8, 2.2	SK16				
	-SZF25C-120,150	7.5~25.4	120, 150	55, 86	84, 114	55	66.5	60~65	SKG25-18HGD	2.4, 2.9	1	SK25
No.50	NBT50-SZF 6C-105,165	0.7~6.0	105, 165	41, 63	-	19.5	40.5, 59.5	26~31	SKG 6- 6HG	4.0, 4.2	2	SK 6
	(NIT50)-SZF10C-105,165	1.75~10.0		41, 101		27.5	48.5	35~41	SKG10-10HG	4.5, 4.9		SK10
	-SZF16C-105,165	2.75~16.0	40	59.5	45~57	SKG16-12HG	5.0, 5.4	SK16				
	-SZF25C-135,165	7.5~25.4	135, 165	71, 101	55	66.5	60~70	SKG25-24HG	5.8, 6.0	1	SK25	

★Adjust screw (G No.), wrench to adjust run-out(9ZFL) and SKL spanner are available as an option. SZF6C: SKL-6W, SZF10C: SKL-10, SZF16C: 9HC16, SZF25C: 9HC25

★Please use "P" class or "A" type SK collet. ☞ P.167

★For centre through coolant application please use SK J type nut and cap for your preference. Please note that the length of J type nut is 6mm longer than the standard SK Nut. ☞ P.43

★For High Speed type, Code No. is "GSZF-P". e.g. MBT40-GSZF10C-90P

In this case, GH Handle is required. ☞ P.30

★For How to Adjust the Run-Out, please refer ☞ P.156.

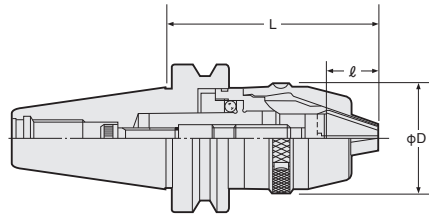
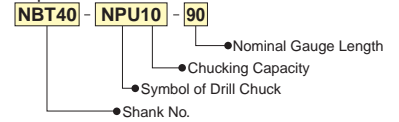


2LOCK NC DRILL CHUCK



Being given favorable reception its Compactness, High Precision & High Rigidity.

Explanation of the Code No.



l : Chucking Length
 NPU 8 : 18.8mm
 NPU13 : 26.5

NPU

TAPER	Code No.	Chucking Dia	D	L		Weight(kg)
				MIN.	MAX.	
No.30	NBT30-NPU 8- 70	0.3~8	38	76.5	83.5	0.7
	-NPU13- 95	1~13	48.5	102.1	113.1	1.2
No.40	NBT40-NPU 8- 70	0.3~8	38	76.5	83.5	1.2
	(NIT40) -110			115.5	122.5	1.5
	-155			160.5	167.5	1.7
	-NPU13- 80	1~13	48.5	86.1	97.1	1.5
	-130			137.1	148.1	2.2
	-175			182.1	193.1	2.7
No.50	NBT50-NPU 8- 85	0.3~8	38	87.5	94.5	3.8
	(NIT50) -110			115.5	122.5	3.9
	-170			175.5	182.5	4.3
	-NPU13- 90	1~13	48.5	97.1	108.1	4.1
	-130			137.1	148.1	4.6
	-190			197.1	208.1	5.2

★Wrench is available as an option. NPU 8: NPUL- 8
 NPU13: NPUL-13

2LOCK SIDE LOCK HOLDER



SLA

A TYPE (for END MILL)

Fig.1

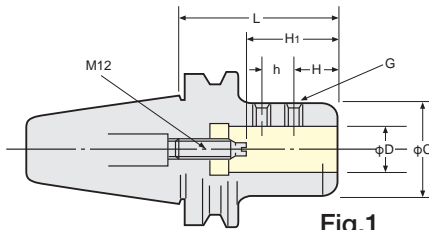


Fig.1

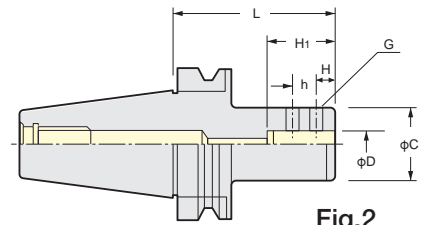


Fig.2

TAPER	Code No.	D	L	C	h	H	H ₁	G	Weight(kg)		
							MIN.~MAX.				
No.30	NBT30-SLA20- 75	20	75	50	21	15	55~ 70	M14 P=1.5	1.3		
No.40	NBT40-SLA20- 90	20	90	50	21	24	55~ 70	M14 P=1.5	1.8		
	(NIT40)-SLA25- 90	25							1.7		
No.50	-SLA32- 90,135*	32	90,135	60	25	25	55~ 70	M16 P=1.5	1.9,2,3		
	NBT50-SLA20-105,135*	20	105,135	50	21	24			55~ 70	M14 P=1.5	4.8,5,2
	(NIT50)-SLA25-105,135*,165*	25	105,135,165								4.7,5,2,5,7
	-SLA32-105,135*,165*	32		60	25	25			65~ 80	M16 P=1.5	4.0,4,9,5,5
	-SLA42-115*,150*	42	115,150	90	32	30	85~100	M20 P=2.0	6.6,7,5		

★Code No. of Side Lock Holder for Combination Shank is DM.
 ★The Code No. of Centre Through Coolant type is "SLOC". P.106

NBT50-DM32-120
 -DM50.8-120



★* marked is available semi-standart.

B TYPE (for DRILL)

Fig.2

TAPER	Code No.	D	L	C	h	H	H ₁	G	Weight(kg)	Collet
No. 40	NBT40-SL20C- 90	20	90	50	16	12	44.5	M10	1.8	—
	-SL25C- 90	25		55	17	14	54.5	M12 P1.25	1.7	OK25
	-SL32C- 90	32		60	16	15	59.5	M12 P1.25	1.9	OK32
No. 50	NBT50-SL20C-105	20	105	50	16	12	44.5	M10	4.8	—
	-SL25C-105	25		55	17	14	54.5	M12 P1.25	4.7	OK25
	-SL32C-105	32		60	16	15	59.5	M12 P1.25	4.9	OK32
	-SL40C-105	40		88	19	18	70	M12 P1.25	5.2	OK40

★Please refer P.111 for Collet and Sleeve.

2Lock

2LOCK MORSE TAPER ADAPTER A TYPE



■ Taper contact area of more than 80% ensures high repeatability run-out accuracy.



MTA

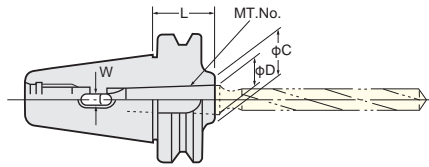


Fig. 1

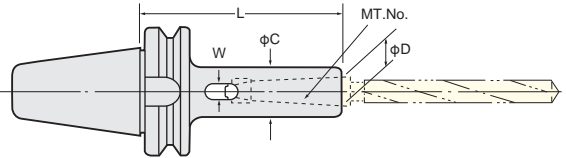


Fig. 2

TAPER	Code No. -L	MT. No.	D	L	C	W	Fig	Weight(kg)
No.30	NBT30-MTA1- 45, 105	1	12.065	45, 105	20, 25	5.6	1, 2	0.8, 0.9
	-MTA2- 60, 120	2	17.780	60, 120	30	6.6		0.9, 1.2
	-MTA3- 80	3	23.825	80	40	8.4	1	1.0
No.40	NBT40-MTA1- 45, 120	1	12.065	45, 120	25	5.6	1, 2	1.0, 1.3
	(NIT40)-MTA2- 60, 120	2	17.780	60, 120	32	6.6		1.1, 1.4
	-MTA3- 75, 135	3	23.825	75, 135	40	8.4		1.2, 1.8
	-MTA4- 95, 165	4	31.267	95, 165	50	12.4		1.4, 2.4
No.50	NBT50-MTA1- 45, 120, 180	1	12.065	45, 120, 180	25	5.6	1, 2, 2	4.0, 4.3, 4.3
	(NIT50)-MTA2- 45, 135, 180	2	17.780	45, 135, 180	32	6.6		4.0, 4.4, 4.6
	-MTA3- 45, 150, 180	3	23.825	45, 150, 180	40	8.4	1, 2	3.9, 4.7, 4.9
	-MTA4- 75, 180	4	31.267	75, 180	50	12.4		4.0, 5.4
	-MTA5-105	5	44.399	105	65	16.5	1	4.6

2LOCK MORSE TAPER ADAPTER B TYPE with DRAW BOLT



■ Taper contact area of more than 80% ensures high repeatability run-out accuracy.



MTB

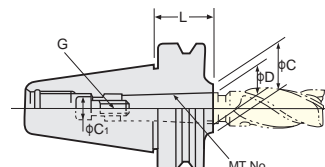


Fig. 1

Draw bolt type

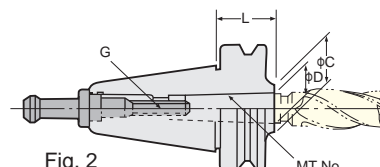


Fig. 2

Pull stud draw bolt type.

TAPER	Code No.	MT.No.	D	L	C	C ₁	G	Fig	Weight(Kg)
No.30	NBT30-MTB1- 45	1	12.065	45	25	10	M 6×1	1	0.8
	-MTB2- 25	2	17.780	25	32	—	M10×1.5	2	0.8
	-MTB3- 80	3	23.825	80	40	—	M12×1.75		1.0
No.40	NBT40-MTB1- 45	1	12.065	45	25	10	M 6×1	1	1.0
	-MTB2- 60	2	17.780	60	32	13.5	M10×1.5		1.1
	-MTB3- 45	3	23.825	45	40	—	M12×1.75	2	1.1
	-MTB4- 85	4	31.267	85	50	—	M16×2		1.3
No.50	NBT50-MTB1- 45	1	12.065	45	25	10	M 6×1	1	3.9
	-MTB2- 45	2	17.780		32	16	M10×1.5		3.9
	-MTB3- 60	3	23.825	60	40	18	M12×1.75		3.9
	-MTB4- 75	4	31.267	75	50	20.5	M16×2		3.9
	-MTB5-105-M16	5	44.399	105	70	—			4.2
	-MTB5-105						M20×2.5		2

★Adapter in Fig.1 is supplied with a special draw bolt.

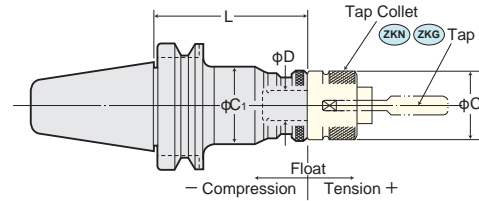
★Morse Taper Adapters B type as illustrated in Fig.2 need the special pull stud. The pull stud is optional accessory. When ordering, please specify the pull stud code number.

2LOCK TAPPER CHUCK

NIKKEN



- Most suitable for tapping gas threads, blind-end threads and light alloys.
- When normal rotation of machine is stopped at specified position, the Tapper Chuck runs idle after progressing by its elongation (4mm for ZL12 type). Simply rotate the machine in the reverse direction, and the tap depth will be made uniform within a high-precision.



ZL AUTO. DEPTH CONTROL

TAPER	Code No.	Tapping Capability			D	L	C	Float		Tap Collet	Weight (kg)
		M	U	P				F ₁	F ₂		
No.40	NBT40-ZL 8-120*1	M 2~ 8	1/8~1/4	—	13	120	34	3	3	ZKN 8*1	1.6
	(NIT40)-ZL12-100	M 2~12	1/8~1/2	P1/16~1/4	19	100	58	5	4	ZKG12	1.9
	-ZL12-130					130					2.3
	-ZL16-150	M 3~16	1/8~5/8	P1/8~3/8	25	150	60			ZKG16	2.9
	-ZL24-160	M 8~24	1/2~ 1	P1/4~5/8	30	160	73	6	7	ZKG24	3.3
	-ZL38-190	M18~38	3/4~13/8	P3/8~ 1	45	190	92	8	10	ZKN38	6.0
No.50	NBT50-ZL 8-130*1	M 2~ 8	1/8~1/4	—	13	130	34	3	3	ZKN 8*1	4.2
	(NIT50)-ZL12- 85	M 2~12	1/8~1/2	P1/16~1/4	19	85	58	5	4	ZKG12	3.4
	-ZL12-130					130					4.3
	-ZL16-135	M 3~16	1/8~5/8	P1/8~3/8	25	135	60			ZKG16	4.6
	-ZL24-100	M 8~24	1/2~ 1	P1/4~5/8	30	100	73	6	7	ZKG24	4.5
	-ZL24-142					142					5.8
-ZL38-150	M18~38	3/4~13/8	P3/8~ 1	45	150	92	8	10	ZKN38	6.9	

★In case of NIT40, NIT40-ZL16-160 and NIT40-ZL24-175 are standard.

★In case of NIT50, NIT50-ZL12-130, NIT50-ZL24-142 and NIT50-ZL38-180 are standard.

★Marked *1 ZL8 Tapper Chuck and ZK8 Tap Collet are available as semi-standard.

★Please refer P.51 (ZKG)~P.52 (ZK) for ISO, IMPERIAL, DIN Tap Collet, P.53 (ZKG)~P.54 (ZKN) for JIS Tap Collet, and P.55 for Long Size Tap Collet.

Z FLOATING

TAPER	Code No.	Tapping Capability			D	L	C	C ₁	Float		Tap Collet	Weight (kg)
		M	U	P					F ₁	F ₂		
No.40	NBT40-Z 8- 90*1	M 2~ 8	1/8~1/4	—	13	90	23	33	5	15	ZKN 8*1	1.4
	(NIT40)-Z12- 90	M 2~ 12	1/8~1/2	P1/16~1/4	19	90	32	45	5	15	ZKG12	1.5
	-Z12-130					130			1.6			
	-Z16-109	M 3~ 16	1/8~5/8	P1/8~3/8	25	109	39	55	8	20	ZKG16	2.0
	-Z24-100	M 8~ 24	1/2~ 1	P1/4~5/8	30	100	46	68	10	20	ZKG24	2.1
	-Z24-187					187			63			20
-Z38-140	M18~ 38	3/4~13/8	P3/8~ 1	45	140	78	85	8	22	ZKN38	6.7	
No.50	NBT50-Z 8-105*1	M 2~ 8	1/8~1/4	—	13	105	23	33	5	15	ZKN 8*1	4.2
	(NIT50)-Z12-130	M 2~ 12	1/8~1/2	P1/16~1/4	19	130	32	45	15	15	ZKG12	4.3
	-Z12-175					175						4.8
	-Z12-220					220						5.0
	-Z16-135	M 3~ 16	1/8~5/8	P1/8~3/8	25	135	39	55	8	20	ZKG16	5.2
	-Z24-142	M 8~ 24	1/2~ 1	P1/4~5/8	30	142	46	63	20	20	ZKG24	5.8
	-Z24-187					187						6.2
	-Z38-175	M18~ 38	3/4~13/8	P3/8~ 1	45	175	78	98	10	25	ZKN38	8.3
-Z65-160	M36~100	1~33/4	P1~ 3	68	160	^{110*2} ₍₁₂₅₎	110	10	25	ZKN65	9.0	

★In case of NIT40, IT40-ZL8-95*1 and NIT40-ZL24-1255 are standard.

★In case of NIT50, IT50-ZL8-105*1, NIT50-ZL38-187 and NIT50-ZL65-165 are standard.

★Marked *1 Z8 Tapper Chuck and ZK8 Tap Collet are available as semi-standard.

★Please refer P.51 (ZKG)~P.52 (ZK) for ISO, IMPERIAL, DIN Tap Collet, P.53 (ZKG)~P.54 (ZKN) for JIS Tap Collet, and P.55 for Long Size Tap Collet.

★Marked *2 () dimension is for M65 or more size of ZK Tap Collet.

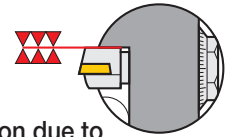
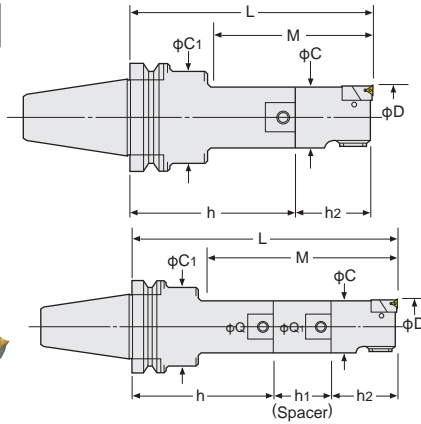
2LOCK

2LOCK ZMAC BORING ARBOR

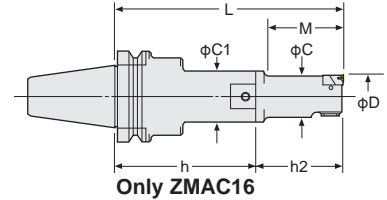


ZMAC

Boring for Finishing



No Micro Vibration due to Double-Contact Support of Cartridge. Long Tool-Life & High Accuracy.

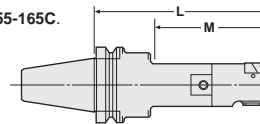


Only ZMAC16

All codes shown are for heads with triangular inserts For heads with rhomboid inserts please add the letter "R" to the code No. e.g. NBT40-ZMAC32 R -150

TAPER	Code No. NBTNo.- Min.D - L	Boring Range D	Boring Depth M	Cupling Dia Q	C	C1	P.98		Weight (kg)
							Head No. Q- Min.D -h2	Insert No.	
No.40	NBT40-ZMAC 16-125, 135	15.9~20.2	38, 48	12	15	24	12-ZMAC16-45, 55	3MP-C,B	1.9, 1.9
	(NIT40)-ZMAC 20-120, 135, 150	19.8~25.2	45, 67, 75	9	19	30	9-ZMAC20-40		1.9, 1.9, 2.0
	-ZMAC 25-120, 150, 165	24.8~32.2	52, 90, 97	12	24	35	12-ZMAC25-40		2.0, 2.1, 2.1
	-ZMAC 32-150, 180, 195	31.8~42.2	77, 110, 122	16	31	42	16-ZMAC32-55	4MP-C,B	2.5, 2.7, 2.7
	-ZMAC 42-150, 180, 210	41.8~55.2	97, 130, 157	20	40	50	20-ZMAC42-70	6MP-C,B	3.0, 3.2, 3.5
	-ZMAC 55-165, 210, 225	54.8~70.2	135, 180, 195	26	53		26-ZMAC55-70		3.9, 4.6, 4.6
	-ZMAC 70-165, 180, 225	69.8~85.2	165, 180, 225	34	67	64	34-ZMAC70-70		5.4, 5.8, 6.8
-ZMAC 85-195	84.8~100.2	195	42	83	62	42-ZMAC85-100	9.0		
No.50	NBT50-ZMAC 16-140, 150	15.9~20.2	38, 48	12	15	24	12-ZMAC16-45, 55	3MP-C,B	4.7, 4.7
	(NIT50)-ZMAC 20-150, 165, 180	19.8~25.2	45, 67, 75	9	19	40	9-ZMAC20-40		4.8, 4.8, 4.9
	-ZMAC 25-135, 165, 180	24.8~32.2	52, 90, 97	12	24	44	12-ZMAC25-40	4.8, 4.8, 4.9	
	-ZMAC 32-180, 210, 225	31.8~42.2	77, 110, 122	16	31	50	16-ZMAC32-55	4MP-C,B	5.5, 5.6, 5.7
	-ZMAC 42-180, 195, 225, 240	41.8~55.2	97, 130, 142, 157	20	40	60	20-ZMAC42-70	6MP-C,B	6.0, 6.0, 6.4, 6.5
	-ZMAC 55-210, 240, 270	54.8~70.2	117, 182, 177	26	53	65	26-ZMAC55-70		7.5, 7.6, 8.1
	-ZMAC 70-240, 270, 300	69.8~85.2	190, 220, 250	34	67	80	34-ZMAC70-70		10.0, 10.6, 11.5
	-ZMAC 85-225, 290, 315	84.8~100.2	182, 247, 272	42	83	83	42-ZMAC85-100		12.5, 15.0, 16.0
-ZMAC100-225, 290*	99.5~140.5	225, 290	42-ZMAC100-100				13.8, 16.5		
-ZMAC140-225, 290*	139.5~180.5						42-ZMAC140-100	14.6, 17.3	

- ★MIN. dial readout : ZMAC25 & smaller is 0.02mm on diameter. ZMAC32 and larger are 0.01mm on diameter.
- ★"C" grade (Coated) insert for Steel, Stainless & Cast Iron is supplied as Standard with the head (Smooth boring & Long tool-life). P.98 Please refer P.96 for cutting condition. We would recommend "B" grade (CBN) insert for Hardened Steel & High Speed boring of Cast Iron.
- ★Please refer P.85 for Shank&Spacer, and P.77, P.78 for Head.
- ★For Centre Through Tool Coolant type, please add "C" at the end of Code No. e.g. BT40-ZMAC55-165C.
- ★For BT30, modular connection system is applied. Please refer P.85 for Base Holder.
- ★When L length is required longer than standard, please specify boring depth M.
- ★* : NBT50-ZMAC100-325, 375, 425, 475 are also available. NBT50-ZMAC140-325, 375, 425, 475



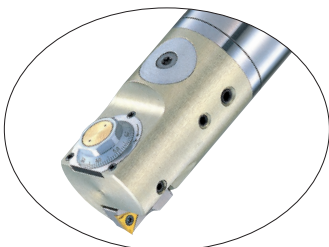
High Pressure Coolant Through Tool

High Speed Boring ZMAC
Special Hardened light alloy metal head with balancing for preventing from high frequency vibration.
Ultra high speed boring: MAX.12,000min⁻¹

ZMAC for Multi-Stage Boring Bar
Please contact us for the special boring bar.



Photo. shows NC5 shank.



Please contact us for your application with the boring diameter. P.78
e.g. NBT40-ZMAC42-150AA
Boring dia.: φ43.5mm

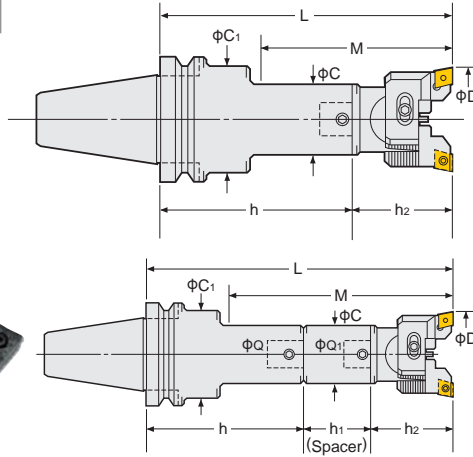
2LOCK BALANCE-CUT BORING ARBOR

NIKKEN

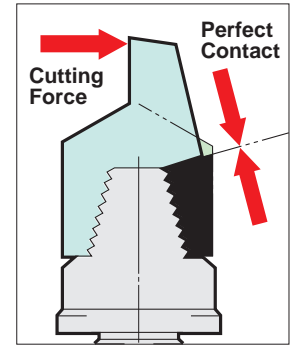
Boring for Roughing



RAC

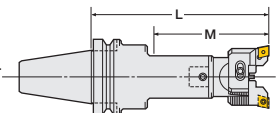


Power of Shoulder Support



TAPER	Code No.	Boring Range D	Boring Depth M	Cupling Dia Q	C	C1	P.62		Weight (kg)
							Head No.	Tip No.	
	NBTPNo.- Min.D -L						Q- Min.D -h2		
No.40	NBT40-RAC 25-135E, 165E, 180E	25~32	67, 105, 112	12	24	35	12-RAC025- 55E	CC07-C	2.0, 2.1, 2.1
	(NIT40)-RAC 32-150E, 180E, 195E	32~45	77, 110, 122	16	31	42	16-RAC 32- 55E	CC08-C	2.4, 2.6, 2.6
	-RAC 43-150E, 180E, 210E	43~55	97, 130, 157	20	40	50	20-RAC 43- 70E	CC12-C	2.7, 2.9, 3.2
	-RAC 53-165E, 210E, 225E	53~70	135, 180, 195	26	50	60	26-RAC 53- 70E		2.5, 3.3, 3.2
	-RAC 70-180E, 195E, 240E	70~100	180, 195, 240	34	64	64	34-RAC 70- 85E		4.8, 5.2, 6.2
	-RAC100-195E	100~130	195	42	83	62	42-RAC100-100E		6.8
No.50	NBT50-RAC 25-150E, 180E, 195E	25~32	67, 105, 112	12	24	44	12-RAC 25- 55E	CC07-C	4.7, 4.9, 4.8
	(NIT50)-RAC 32-180E, 210E, 225E	32~45	77, 110, 122	16	31	50	16-RAC 32- 55E	CC08-C	5.4, 5.6, 5.6
	-RAC 43-180E, 195E, 225E, 240E	43~55	97, 130, 142, 157	20	40	60	20-RAC 43- 70E	CC12-C	5.7, 5.8, 6.1, 6.2
	-RAC 53-210E, 240E, 270E	53~70	117, 182, 177	26	50	65	26-RAC 53- 70E		6.9, 7.0, 7.6
	-RAC 70-255E, 285E, 315E	70~100	205, 235, 265	34	64	80	34-RAC 70- 85E		9.5, 9.9, 10.9
	-RAC100-225E, 290E, 325E*	100~130	225, 290, 325	42	83	83	42-RAC100-100E		12.5, 12.5, 16.5

- ★ "C" grade (Coated) inserts are supplied as standard with the head. P.62 Please refer P.93 for cutting condition.
- ★ Please refer P.179 for base holder, P.86 for spacer and P.67 for head.
- ★ For centre through tool coolant type, please add "C" at the end of Code No. e.g. NBT40-RAC53-165-C
- ★ Cartridges & Insert tips for the Heavy Duty Boring of Iron and Cast Iron (No letter), for Aluminum (A), and for Through Hole & Multiple Sheets (K) are available. Please refer P.69 for cartridges. Please add the letter "No letter", "A" or "K" at the end of Code No. e.g. NBT40-RAC53-165A
- ★*: NBT50-RAC100-375E, 425E and 475E are also available.



Code No. of RAC25 and RAC32 with CC inserts are changed to RAC25E and RAC32E. Please refer P.61, P.62

2LOCK MAJOR DREAM HOLDER BASE HOLDER for MODULAR TYPE

NIKKEN



MDQ

Photo shows with A1 spacer and ZMAC head.

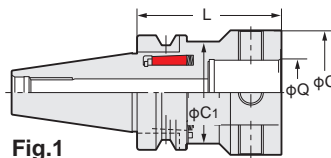


Fig.1

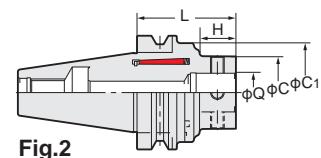
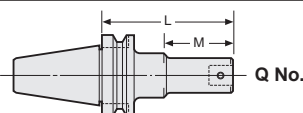


Fig.2

TAPER	Code No.	Q	L	C	C1	H	Weight (kg)	ZMAC Boring Range	Fig
No.30	NBT30-MDQ26- 60	26	60	50	50	37.5	-	16~70	1
No.40	NBT40-MDQ26- 65	26	65	50	54	30.0	1.3	16~70	2
	(NIT40)-MDQ26- 65								
No.50	NBT50-MDQ26- 80	26	80	50	87	22.0	4.6	16~70	2
	(NIT50)-MDQ34- 90	34	90	64	87	32.0	4.9	16~85	
	-MDQ42-100	42	100	83	87	45.0	5.7	16~180	

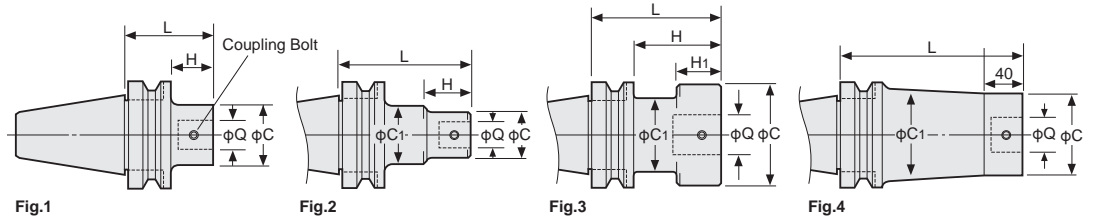
- ★ All base holders are used for centre through tool coolant.
- ★ Coupling bolt and wrench are supplied as standard.
- ★ ZMAC head is recommended to use with the MAJOR DREAM base holder for anti-vibration.
- ★ When L length is required longer than standard, please specify the boring depth M and Q No.



2Lock

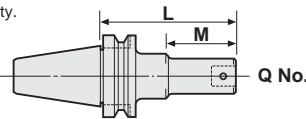
2LOCK BASE HOLDER for MODULAR TYPE

NIKKEN



TAPER	Code No.	Coupling Dia Q	L	C	C ₁	H	H ₁	Coupling Bolt No.	Fig.	Weight(kg)
No.30	NBT30-Q 9- 50	9	50	19	30	20		B19	2	0.5
	-Q12- 65	12	65	24		40		B12	1	
	-Q16- 50	16	50	31	-	25		B16		
	-Q20- 50	20		40		26		B20		
	-Q26- 40	26	40	50	45	18	6	B26N	3	
No.40	NBT40-Q 9- 80, 95N	9	80,95	19	30	5,27		B19	2	1.2, 1.2
	(NIT40)-Q12- 80,110	12	80,110	24	35	12,50		B12		1.2, 1.3
	-Q16- 95,125	16	95,125	31	42	22,55		B16		1.5, 1.6
	-Q20- 80,110	20	80,110	40	50	27,60		B20	1	1.5, 1.7
	-Q26- 50, 95,140	26	50,95,140	50	-	20,65,110		B26N		1.1, 1.8, 2.4
	-Q34- 95,110	34	95,110	64	62	68,83	55,70	B34	3	2.2, 2.6
	-Q42- 95	42	95	83	62	68	55	B42		2.8
No.50	NBT50-Q 9-110,125N	9	110,125	19	40	5,27		B19	2	4.1, 4.1
	(NIT50)-Q12- 95,125	12	95,125	24	44	12,50		B12		4.0, 4.0
	-Q16-125N,155	16	125,155	31	50	22,55		B16		4.5, 4.6
	-Q20-110,125	20	110,125	40	60	27,60		B20	1,2,2	4.6, 4.5
	-Q26- 65,140,170N	26	65,140,170	50	65	27,47,112		B26N		3.7, 5.3, 5.4
	-Q34-140,170,200	34	140,170,200	64	80	102,120,150		B34	1,2,2	5.6, 6.5, 7.1
	-Q42-125,190		125,190	83	-	87,152				1
-Q42-225A,275A 325A,375A	42	225,275 325,375	83	98	-		B42	4	12.9, 15.6 18.3, 21.0	

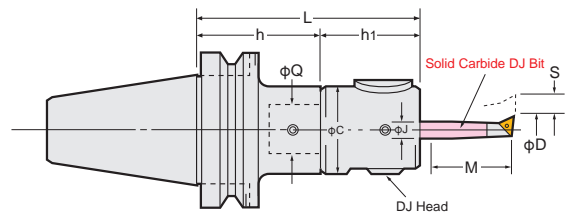
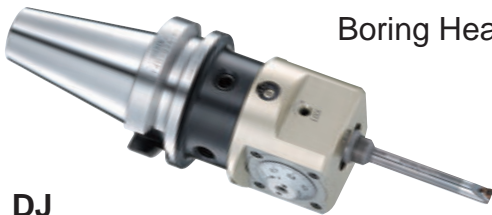
- ★φC of Q26 base holder has been increased from 45mm to 50mm due to improvement of its rigidity.
- ★All base holders have a centre through-tool coolant hole.
- ★The Coupling screw & wrench are supplied as standard.
- ★When L length is required longer than standard, please specify the boring depth M.



2LOCK DJ BORING BAR

NIKKEN

For both wide range small quantity production and mass production
Boring Head with **Power of Solid Carbide DJ Bit**

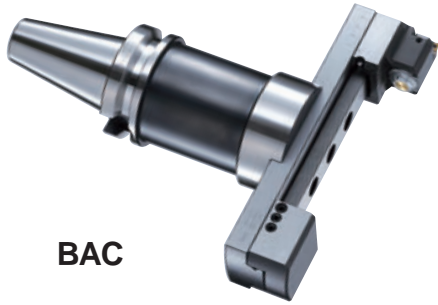


TAPER	Code No.	Boring Range	Boring Depth	L	C	Bit Hole Size	Shank Code No.	Head Code No.	Bit Stroke	DJ Bit Code No.
	NBTNo.-MinD-L	D	M			J	NBTNo.Q-h	Q-MinD-h ₁	S	
No.30	NBT30-DJ3- 76	3~28	14~ 80	76	45	10	NBT30-Q26- 40	Q26-DJ3-36	5.2	J10
	-DJ8- 84AN	3~50	14~130	84	59	16		-DJ8-44AN	6.0	J16
No.40	NBT40-DJ3- 86	3~28	14~ 80	86	45	10	NBT40-Q26- 50	Q26-DJ3-36	5.2	J10
	(NIT40) -131			131						
	-DJ8- 94AN	3~50	14~130	94	59	16	NBT40-Q26- 50	-DJ8-44AN	6.0	J16
	-139AN			139						
No.50	NBT50-DJ3-101	3~28	14~ 80	101	45	10	NBT50-Q26- 65	Q26-DJ3-36	5.2	J10
	(NIT50) -206			206						
	-DJ8-109AN	3~50	14~130	109	59	16	NBT50-Q26- 65	-DJ8-44AN	6.0	J16
	-214AN			214						

- ★MIN. dial readout on dia.: 0.01mm, Sub scale: 0.005mm, 0.8mm/rev.
- ★Bits included for NBT40-DJ8-94A : J16-8-40, J16-18-80, J16-28-85, J16-38-85
- ★Bits included for NBT40-DJ8-94AN : J16-8-40, J16-18-60, J16-28-65, J16-38-65
- ★DJ Boring Bar without Boring Bits is also available. Please add“-BD”at the end of Code No. e.g. NBT40-DJ3-86-BD
- ★Shank and DJ Head(including Boring Bits)are delivered in separate packages.
- ★Each boxed set of DJ3 and DJ8 Boring Bars include 4 pcs of DJ Boring Bits as standard.
- ★Please refer P.84 for Boring Bits. Please refer P.97 for cutting condition.

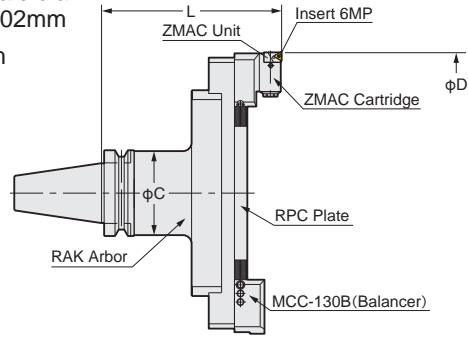
2LOCK BALANCE-CUT BAC BORING ARBOR for LARGE DIA.

NIKKEN



BAC

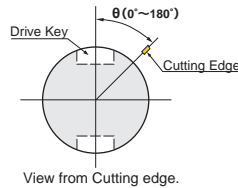
- Min. dial read out: main scale dia. 0.02mm, sub scale dia. 0.002mm
- Boring Dia: $\phi 130 \sim 595\text{mm}$



Boring Dia: $\phi 130 \sim 595\text{mm}$ for Finishing.

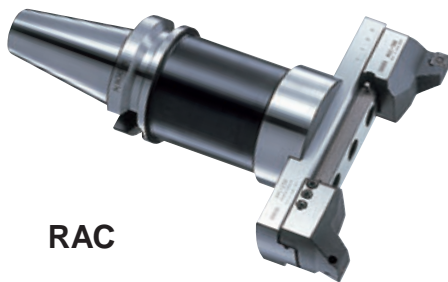
TAPER	Code.No	D	L	C	RAK Arbor Code No.	PPC Plante No	Cartridge (Balancer)	Weight (kg)
		MIN.~MAX.						
No.40	NBT40 -BAC130-205	130~195	205	61	NBT40-RAK-130	RPC-130	MCCZ-130 (MCC-130B)	6.8
	(NIT40) -BAC180-205	180~245				-180		7.8
No.50	NBT50 -BAC130-185, 235, 285	130~195	185, 235, 285	90	NBT50-RAK-110, 160, 210	RPC-130	Insert Tip 6MP	13.0, 14.5, 17.5
	(NIT50) -BAC180-185, 235, 285	180~245				-180		13.5, 15.0, 18.0
	-BAC230-185, 235, 285	230~295				-230		14.0, 15.5, 18.5
	-BAC280-185, 235, 285	280~345				-280		14.5, 16.0, 19.0
	-BAC330-210*	330~395	210 (220*)	98	NBT50-RAK330-125 NIT50-RAK330-135*	RPC-330		16.2
	-BAC380-210*	380~445				-380		16.5
	-BAC430-210*	430~495				-430		17.5
	-BAC480-210*	480~545				-480		18.5
-BAC530-210*	530~595	-530	19.5					

- ★ "C" grade (Coated) Inserts are supplied as standard. ★ Please refer P.95 for cutting condition.
- ★ Unit "M5HZ-55" is provided as standard, please refer P.72 for Arbor (RAK) and Plate (RPC).
- ★ Arbor, Plate and Cartridge are delivered in separate packages.
- ★ When ordering, please let us know machine maker and model no. to avoid the interference with tool magazine of ATC.
- ★ The location of cutting edge is same as drive key in standard.
- The different location is available, please specify θ in Code No. e.g. NBT50-BAC180-235 (90°)
- ★ The boring arbors marked*with NIT50, L (gauge length) is 220. e.g. NIT50-BAC330-220



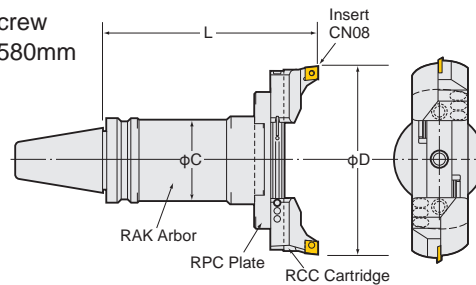
2LOCK BALANCE-CUT BAC BORING ARBOR for LARGE DIA.

NIKKEN



RAC

- With slight adjust screw
- Boring Dia: $\phi 130 \sim 580\text{mm}$



Boring Dia: $\phi 130 \sim 580\text{mm}$ for Roughing.

TAPER	Code.No	D	L	C	RAK Arbor Code No.	PPC Plante No	Cartridge No. for Large dia.	Weight (kg)	
		MIN.~MAX.							
No.40	NBT40 -RAC130-205	130~180	205	61	NBT40-RAK-130	RPC-130	For Heavy Duty Boring of Iron and Cast Iron	6.8	
	(NIT40) -RAC180-205	180~230				-180		7.8	
No.50	NBT50 -RAC130-185, 235, 285	130~180	185, 235, 285	90	NBT50-RAK-110, 160, 210	RPC-130	RCC-130 x2	11.3, 12.8, 15.8	
	(NIT50) -RAC180-185, 235, 285	180~230				-180		11.8, 13.3, 16.3	
	-RAC230-185, 235, 285	230~280				-230		12.3, 13.8, 16.8	
	-RAC280-185, 235, 285	280~330				-280		12.8, 14.3, 17.3	
	-RAC330-210*	330~380	210 (220*)	98	NBT50-RAK330-125 NIT50-RAK330-135*	RPC-330		Insert Tip CN08	15.5
	-RAC380-210*	380~430				-380			16.5
	-RAC430-210*	430~480				-430			17.5
	-RAC480-210*	480~530				-480			18.5
-RAC530-210*	530~580	-530	19.5						

- ★ The Code No. on above table are the boring arbors with RCC-130 cartridge (Insert tip: CN08) the Heavy Duty Boring of Iron and Cast Iron. Please refer P.95 for cutting condition.
- ★ Boring arbor with cartridges & insert for Steel, Stainless Steel and Cast Iron (E), for Aluminum (A) and for Through Hole & Multi Sheets (K) are available. Please refer P.72 for cartridges. e.g. NBT50-RAC130-185E
- ★ Arbor, Plate and Cartridge are delivered in separate packages. ★ When ordering, please let us know machine maker and model no. to avoid the interference with tool magazine of ATC.
- ★ The location of cutting edge is same as drive key in standard. The different location is available, please specify θ in Code No. e.g. NBT50-RAC180-235 (90°)
- ★ The boring arbors marked*with NIT50, L (gauge length) is 220. e.g. NIT50-RAC330-220

2Lock

2LOCK FACE MILL ARBOR (JIS)

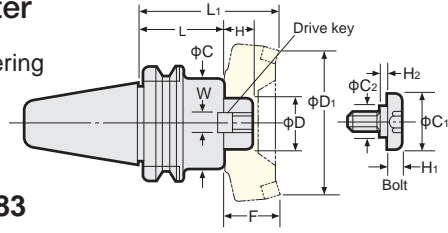


FMA

For JIS B4113 Face Mill Cutter

Taper contact area of more than 80% ensures reliable milling with no chattering accompanied

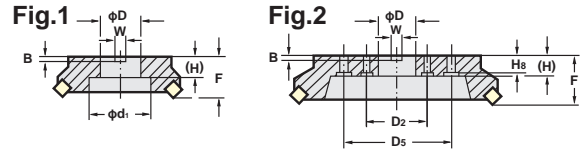
FMH Arbor for High Feed with Coolant Through P.183



TAPER	Code No. (ϕD -L)	Dimensions								Weight (kg)	Dimension of Arbor with cutter			Drive Key	Bolt
		H	C	W	C ₁	C ₂	H ₁	H ₂	L ₁		D ₁	F			
No.30	NBT30-FMA25.4 - 45	22	50	9.5	33	23	10	2	1.3	95	80	50	FW 5	FM12	
	NBT40-FMA25.4 - 45	22	50	9.5	33	23	10	2	1.5	95	80	50	FW 5	FM12	
No.40	-FMA25.4 - 90								3.1	140			FW 5		
	-FMA31.75 - 45	30	60	12.7	40	23	10	6	1.7	105	100	60	FW13	FM16	
	-FMA31.75 - 75								3.1	135					
	-FMA38.1 - 60	34	80	15.9	50	27	14	6	2.9	120	125	60	FW18	FM20	
No.50	NBT50-FMA25.4 - 45								3.7	95					
	-FMA25.4 - 90	22	58	9.5	33	23	10	2	4.6	140	80	50	FW 5	FM12	
	-FMA25.4 -150								5.5	200					
	-FMA31.75 - 45								4.5	105			FW12		
	-FMA31.75 - 75	30	70	12.7	40	23	10	6	5.3	135	100	60	FW13	FM16	
	-FMA31.75 -105								6.1	165					
	-FMA38.1 - 45	34	80	15.9	50	27	14	6	4.3	105	125	60	FW18	FM20	
	-FMA38.1 - 75								5.6	135			FW19		
	-FMA50.8 - 45	36	100	19	65	37	14	10	4.9	105	160	60	FW23	FM24	
	-FMA50.8 - 75								6.8	135			FW24		
	-FMA47.625- 75	38	128.57	25.4	—	—	—	—	7.7	135	200	60	FW26	*	

- ★ Drive keys, L-Wrench & Bolt are supplied as standard.
- ★ The arbor marked *requires 4 fixing bolts.
- ★ Above weight is for Arbor only. (Not include Face Mill Cutter)
- ★ FMA25.4 type Arbor is suitable for NIKKEN PRO-END MILL $\phi 60$ (PE60HC) and $\phi 80$ (PE80HC).
- ★ FMA31.75 type Arbor is suitable for NIKKEN PRO-END MILL $\phi 100$ (PE100HC). Please refer P.103.
- ★ Code No. of Centre Through Coolant type FMA Arbor for NIKKEN PRO-END MILL is : e.g. NBT40-FMA25.4C-45
- ★ Extended length Face Mill Arbors are available on request.
- NBT50-FMA25.4 -200,-250
- FMA31.75-150,-200
- FMA38.1 -150,-200
- ★ Diameter ϕC of NBT50-FMA25.4 and NBT50-FMA31.75 are enlarged.

In case of the special cutter, please specify the dimensions below.



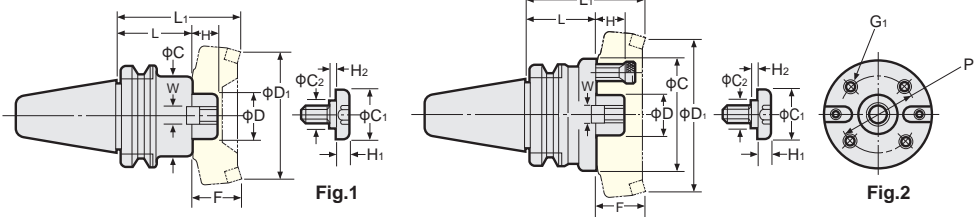
2LOCK FACE MILL ARBOR



FMB

Inch Series

Taper contact area of more than 80% ensures reliable milling with no chattering accompanied



(●) figures for Metric Series

Metric Series

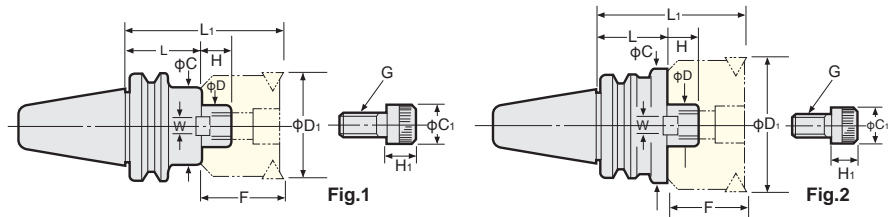
TAPER	Code No. (ϕD -L)	Dimensions										Weight (kg)	Dimension of Arbor with cutter			Fig.	Code No. (ϕD -L)
		H	C	W	C ₁	C ₂	H ₁	H ₂	G ₁	P	L ₁		D ₁	F			
No.30	NBT30-FMB25.4 - 45	26	80	9.5(12)	33	23	10	2	—	—	1.7	95	80	50	1	NBT30-FMB27 - 45	
	NBT40-FMB25.4 - 60										2.5	110	80	50	1	NBT40-FMB27 - 60	
No.40	-FMB25.4 - 90	26	80	9.5(12)	33	23	10	2	—	—	4.7	140			1	-FMB27 - 90	
	-FMB38.1 - 60		85	15.9(16)	50	27	14	6	—	—	7.4	123	125	63	1	-FMB40 - 60	
No.50	NBT50-FMB25.4 - 45										4.0	95			1	NBT50-FMB27 - 45	
	-FMB25.4 - 90										5.8	140	80	50	1	-FMB27 - 90	
	-FMB25.4 -150										8.2	200			1	-FMB27 -150	
	-FMB38.1 - 45	26									4.7	108			1	-FMB40 - 45	
	-FMB38.1 - 75		85								6.1	138			1	-FMB40 - 75	
	-FMB38.1 -105			15.9(16)	50	27	14	6	—	—	8.7	168	125	63	1	-FMB40 -105	
	-FMB38.1F- 75		110								M12	66.7			2	-FMB40F- 75	
	-FMB60 - 75	25	140	25.4	—	—	—	—			M16	101.6	200	63	2	-FMB60 - 75	

- ★ Drive keys, L-Wrench & Bolt are supplied as standard.
- ★ Above weight is for Arbor only. (Not include Face Mill Cutter)

2LOCK SHOULDER CUTTER ARBOR

NIKKEN

Taper contact area of more than 80% ensures reliable Milling with no chattering accompanied.



FMC

Inch Series

(●) figures for Metric Series

Metric Series

TAPER	Dimensions				Weight (kg)	Dimensions of Arbor with cutter				C ₁	H ₁	Fig	Code No.(φD -L)
	Code No.(φD -L)	H	C	W		L ₁	D ₁	F	G CAP bolt				
No.30		18	45	10	1.4	80	50	40	M10×30	16	10	1	NBT30-FMC22- 40
No.40		18	45	10	1.3	85	50	40	M10×30	16	10	1	NBT40-FMC22- 45
					2.0	130							FMC22- 90
	NBT40-FMC25.4- 60	20	60	9.4(12)	1.5	110	80	50	M12×35	18	12	2	FMC27- 60
	-FMC25.4- 90				2.2	140							FMC27- 90
	-FMC38.1- 60	22	85	15.5(14)	2.3	110							125
-FMC38.1- 75				2.6	125	FMC32- 75							
No.50		18	45	10	4.2	100	50	40	M10×30	16	10	1	NBT50-FMC22- 60
					4.7	145							FMC22-105
					5.3	190							FMC22-150
	NBT50-FMC25.4- 45		20	70	9.4(12)	4.1	95	80	50	M12×35	18	12	FMC27- 45
	-FMC25.4- 90					5.5	140						FMC27- 90
	-FMC25.4-150					7.3	200						FMC27-150
	-FMC38.1- 45		22	85	15.5(14)	4.2	95	125	50	M16×35	30(24)	15(16)	FMC32- 45
	-FMC38.1- 75					5.5	125						FMC32- 75
	-FMC38.1-105					7.0	155						FMC32-105

★Drive keys, L-Wrench & Bolt are supplied as standard.

★Above weight is for Arbor only. (Not include Face Mill Cutter)

★FMC22 type Arbor is suitable for NIKKEN PRO-END MILL φ50(PE50HC). 参考P.103

★Code No. of Centre Through Coolant type FMC Arbor for NIKKEN PRO-END MILL is e.g. NBT40-FMC22C-45.

2LOCK SHELL END MILL ARBOR

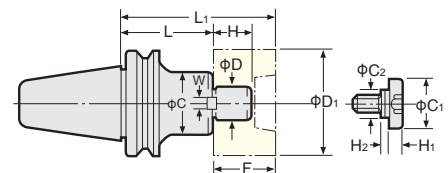
NIKKEN



SMA

JIS B4214 for SHELL END MILL

Taper contact area of more than 80% ensures reliable Milling with no chattering accompanied.



Inch Series

(●) figures for Metric Series

Metric Series

TAPER	Dimensions								Weight (kg)	Dimensions of Arbor with cutter			Code No.(φD -L)
	Code No.(φD -L)	H	C	W	C ₁	C ₂	H ₁	H ₂		L ₁	D ₁	F	
No.30	NBT30-SMA15.875-30	17	34	8	20	15	7	2	0.9	60	35	30	NBT30-SMA16-30
	-SMA22.225-30	27	42						1.0	75	45(50)	45	-SMA22-30
No.40	NBT40-SMA15.875-60,120	17	34	8	20	15	7	2	1.3-1.7	90-150	35(40)	30	NBT40-SMA16-60,120
	-SMA22.225-60,120	27	42						1.4-2.1	105-165	45(50)	45	-SMA22-60,120
	-SMA25.4 -45,105	36	50	10	33	23	10	6	1.4-2.3	105-165	60(75)		-SMA27-45,105
	-SMA31.75 -45,75	38	60						1.6-2.3	106-135	100	60	-SMA32-45,75
	-SMA38.1 -60	80	12						50	27	14	3.0	120
No.50	NBT50-SMA15.875-75,120	17	34	8	20	15	7	2	4.2-5.8	105-150	35(40)	30	NBT50-SMA16-75,120
	-SMA22.225-75,120,180	27	42						4.3-4.8-5.5	120-165-225	45(50)	45	-SMA22-75,120,180
	-SMA25.4 -60,105,150	36	50	10	33	23	10	6	4.3-5.2-5.8	120-165-210	60(75)		-SMA27-60,105,150
	-SMA31.75 -45,75,105	38	60						4.2-5.2-6.2	105-135-165	100	60	-SMA32-45,75,105
	-SMA38.1 -45,75	80	12						50	27	14	4.3-5.5	105-135

SMB

Inch Series

TAPER	Dimensions								Weight (kg)	Dimensions of Arbor with cutter		
	Code No.(φD -L)	H	C	W	C ₁	C ₂	H ₁	H ₂		L ₁	D ₁	F
No.30	NBT30-SMB22.225-50	17	40	8	28	18	9	2	1.0	65	50	35
No.40	NBT40-SMB22.225-45,120	17	45	8	28	18	9	2	1.3-2.2	80-155	50	35
	-SMB31.75 -45,75	30	60	12.7	40	23	10	6	1.6-2.3	95-125	75	50
	-SMB38.1 -60	36	80	15.9	50	27	14	6	2.8	120	100	60
No.50	NBT50-SMB22.225-60,120,180	17	45	8	28	18	9	2	4.3-5.0-5.7	95-155-215	50	35
	-SMB31.75 -45,75,105	30	60	12.7	40	23	10	6	4.2-5.2-6.2	95-125-155	75	50
	-SMB38.1 -45,75,	36	80	15.9	50	27	14	6	4.3-5.5	105-135	100	60

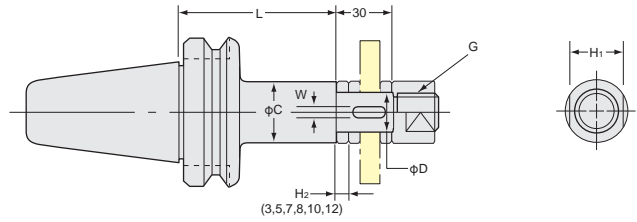
★Above weight is for Arbor only. (Not include Face Mill Cutter)

2LOCK

Taper contact area of more than 80% ensures reliable milling with no chattering accompanied.



SCA



Inch Series

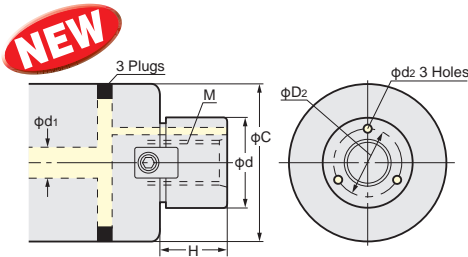
(●)figures for Metric Series

Metric Series

TAPER	Code No.(φD-L)	H ₁	C	W	G	Weight(kg)	Code No.(φD-L)
No.30	NBT30-SCA12.7 -60	17	20	—	M12	1.0	NBT30-SCA13-60
	-SCA15.875-60	23	26	3.18 (4)	M14	1.1	-SCA16-60
	-SCA22.225-60	29	34	3.18 (6)	M20	1.2	-SCA22-60
	-SCA25.4 -60	32	40	6.35 (7)	M24	1.3	-SCA27-60
No.40	NBT40-SCA12.7 -75,105	17	20	—	M12	1.2, 1.3	NBT40-SCA13-75,105
	(NIT40)-SCA15.875-75,105	23	26	3.18 (4)	M14	1.4, 1.5	-SCA16-75,105
	-SCA22.225-75,120	29	34	3.18 (6)	M20	1.7, 2.0	-SCA22-75,120
	-SCA25.4 -75,120	32	40	6.35 (7)	M24	2.0, 2.4	-SCA27-75,120
	-SCA31.75 -90	41	46	7.92 (8)	M30	2.6	-SCA32-90
No.50	NBT50-SCA12.7 -75,105	17	20	—	M12	4.0, 4.3	NBT50-SCA13-75,105
	(NIT50)-SCA15.875-90,120	23	26	3.18 (4)	M14	4.2, 4.4	-SCA16-90,120
	-SCA22.225-90,135	29	34	3.18 (6)	M20	4.4, 4.7	-SCA22-90,135
	-SCA25.4 -90,135	32	40	6.35 (7)	M24	4.5, 4.9	-SCA27-90,135
	-SCA31.75 -90,135	41	46	7.92 (8)	M30	4.7, 5.2	-SCA32-90,135
	-SCA38.1 -90,135	46	55	9.52 (10)	M36	4.9, 5.9	-SCA40-90,135

★JIS B4206, JIS B4107, JIS B4219, JIS B4109 cutters can be attached.
 ★Key and Collars(Hz=3, 5, 7, 8, 10, 12) are supplied as standard. P.104
 ★The Code No. of Nut is unified from "GN" to "GNT".

FMH High Feed Cutter Arbor with Coolant Hole



Code No.	Cutter Dia.	φd	φC	M	H	Coolant Hole		
						φD2	φd1	φd2
FMH22 (22.225)	φ50, φ52	22(22.225)	47	M10×1.5	18(17)	16	6~8	3
	φ63, φ66		60					
FMH27 (25.4)	φ80	27(25.4)	76(70)	M12×1.75	20(22)	19.5(18.5)	8~10	3.5
FMH32 (31.75)	φ100	32(31.75)	96	M16×2.0	22(30)	24	10~13	4
FMH40 (38.1)	φ125	40(38.1)	100	M20×2.5	26(34)	30(29)	10~15	5
FMH50.8	φ160	50.8	100	M24×3.0	36	37.5	15~20	7

★Fixing dimension is basically based on FMA/FMC. ★The combination of the other cutter dia. are also available.

FMH

TAPER	Code No. (φD-φC-L)	Dimensions						Weight (kg)	Drive key	Bolt	G Cap Bolt	
		H	C	W	C ₁	C ₂	H ₁					H ₂
No.40	NBT40-FMH22 - 47(60)-45	18	47(60)	10	16	—	10	1.3(1.4)	FW 8	—	M10×30	
	-FMH27 - 60(76)-60	20	60(76)	12	18	—	12	1.8(2.2)	FW11		M12×35	
	-FMH32 - 96-60	22	96	14	24	—	16	2.9	FW16		M16×35	
	-FMH40 -100-60	26	100	16	50	27	14	6	3.1		FW22	FM20
No.50	NBT50-FMH22 - 47(60)-60	18	47(60)	10	16	—	10	4.2(4.5)	FW 8	—	M10×30	
	-FMH27 - 60(76)-45	20	60(76)	12	18	—	12	3.9(4.1)	FW10		M12×35	
	-FMH32 - 96-45	22	96	14	24	—	16	4.2	FW15		M16×35	
	-FMH40 -100-45	26	100	16	50	27	14	6	5.1		FW20	FM20
	-FMH50.8 -100-45	36		19	65	37	14	10	4.4		FW23	FM24

★FMH22.225, FMH25.4, FMH31.75 and FMH38.1 are also available.
 ★For FMH22, there are two types of φC, φ47 and φ60.
 ★For FMH27, there are two types of φC, φ60 and φ76.

2LOCK HIGH SPEED SPINDLE SPEEDER

NIKKEN

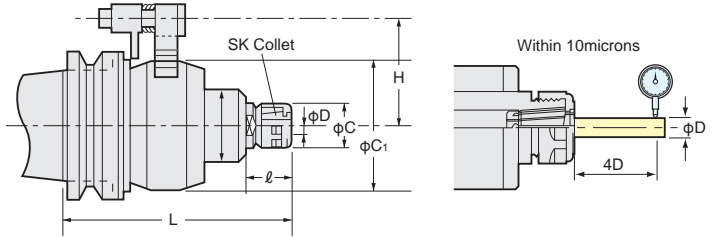
10,000~40,000min⁻¹

- NIKKEN NX increases the spindle speed by 4 or 5 times, so economically convert your standard M/C to high speed M/C.
- Inside gears are mirror-finish ground by NIKKEN original Fluid-Dynamic Grinding Process.
- Run-out accuracy is more stable due to TiN Bearing Nut (standard accessory).



NX, PX

Explanation of the Code No.
NBT40-NX 5 160
 • Shank
 • Ratio
 • Length
 • NX: 4times, 5 times
 • PX: 6times, 10 times



TAPER	Code No.	D	L	C	C ₁	l	H	Ratio	MAX. min ⁻¹	Weight(kg)	Collet	
No.30	NBT30-NX 5-153	1.75~10	153	27.5	85	32	55	5	20,000	2.9	SK 10A	
	NBT40-NX 5-153		153									
No.40	(NIT40)-PX 6-150GX	0.5~8.0	149	22	76	14.5	60	6	30,000	4.1	ETS14	
	-PX10-160GX		162.5									
No.50	NBT50-NX 4-192	2.75~16	192	40	118	46	82	4	10,000	11.0	SK 16A	
	(NIT50)-NX 5-151	1.75~10	151	27.5	85			5	20,000	7.0	SK 10A	
	-PX 6-140GX	0.5~8.0	142	22	76			14.5	6	30,000	6.8	ETS14
	-PX10-155GX		155.5						98	10	40,000	

NX type

- ★ For End Mill, please use SK A type collet. For Drill, please use SK-P class collet. (P.39)
- ★ Wrench, Collet Extractor and A type SK Collets are supplied as standard.
- NX5: SK10-6A, 8A, 10A NX4: SK16-8A, 10A, 12A, 16A
- ★ Stopper block is available as an option. When ordering, please inform your M/C maker and Model as well as your M/C spindle flange dimension.
- ★ Air Cylinder for Cooling (NXE-COOL) is highly recommended to use for the stable milling.



Air Cylinder for Cooling with ON/OFF Magnet NXE-COOL

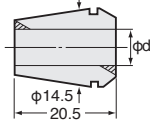
The best cooling is to cool the speeder body directly.



PX type

- ★ Grease lubrication is standard.
- ★ Please add "MX" instead of "GX" at the end of Code No. for the oil mist lubrication. e.g. NBT40-PX6-130MX
- ★ ETS collet is supplied as an option.

ETS Collet



Explanation of the Code No.

ETS 14 - 0.5
 • MAX. Chucking Dia.
 • Style No.
 • Symbol of ETS Collet

- ★ φd=0.5~1.0: Each 0.1mm (Gripping range: 0.1mm) e.g. ETS14-0.5: 0.4~0.5mm
- ★ φd=1.25~2.5: Each 0.25mm (Gripping range: 0.25mm)
- ★ φd=3.0~8.0: Each 0.5mm (Gripping range: 0.5mm)

2LOCK AIR TURBINE SPINDLE TOOL

NIKKEN

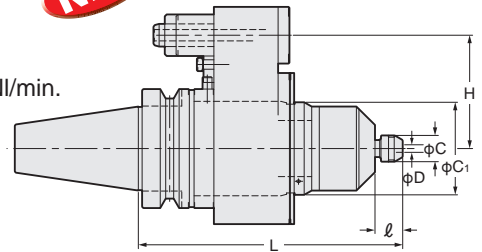


150,000min⁻¹

Run-out Accuracy of the Spindle: Within 1μm

Air Pressure, Consumption: 0.5MPa, 90NI/min.
 Collet Size: MAX φ4.0mm

NEW



HTS

Explanation of the Code No.
NBT40-HTS1500-140
 • Shank No.
 • Symbol of Air Turbine Spindle
 • 150,000min⁻¹
 • Nominal Gauge Length

HSK shank is also available.

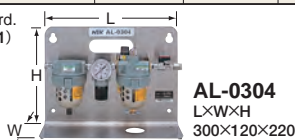
HSK 50A-HTS1500-158
 HSK 63A-HTS1500-160
 HSK100A-HTS1500-167



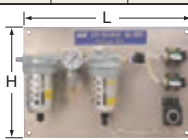
Please do not rotate the machine spindle.

TAPER	Code No.	D	L	C	C ₁	l	H	MAX. min ⁻¹	Weight(kg)	Collet
No.30	NBT30-HTS1500-148	0.5~4	148	13.9	49	15	55	150,000	2.7	CHA-□ (Internal dia.)
	-HTS1500-152B		152							
No.40	NBT40-HTS1500-140		140				60		3.2	
No.50	(NIT40) HTS1500-140						82		6.0	
	(NIT50) HTS1500-146		146							

- ★ Collet CHA-4.0 and spanner are supplied as standard.
- ★ Air line kit (AL-0304/AL-951), the lubrication oil (K-211) and the stopper block are available as an option.



AL-0304
 L×W×H
 300×120×220



★ The collet which internal dia. excepts φ4.0mm is available as an option. CHA-2.35, 3.0, 3.175
 The internal dia. range is each 0.1mm incremental from φ0.5 to φ4.0mm.
 AL-951 (DC24V ON/OFF)
 L×H
 490×320

2LOCK

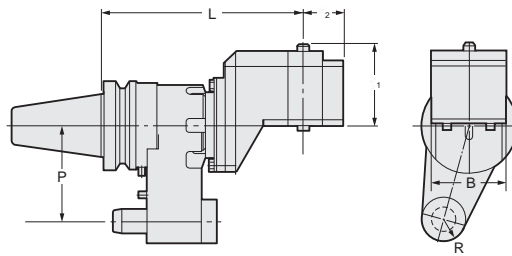
2LOCK QUICK TYPE ANGULAR HEAD (Free Positioning in 360°)



Quick type Off-Set Angular Head



AFT



Explanation of the Code No.

NBT40 - AF T 30 - 200

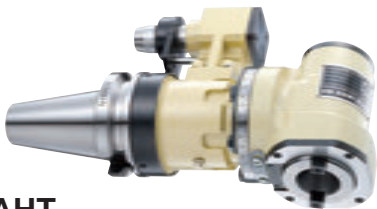
- Length from Gauge Line
- Taper No. of Adapter
- Quick type
- Off-Set type Angular Head
- Shank

MAX 2,000 min⁻¹

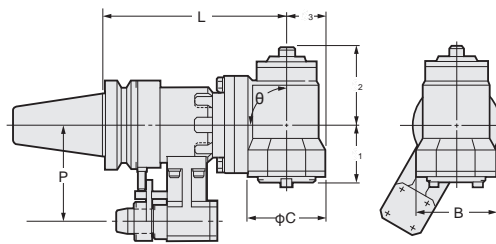
TAPER	Code No.	Shank	L	P	l ₁	l ₂	B	R	Adapter	Weight(kg)
No.40	NBT40 (NIT40)-AFT30-200	NBT40	200	65	85	35	70	17.5	AHK30	7.5
No.50	NBT50 (NIT50)-AFT35-230	NBT50	230	110	85	45	84	25	AHK35	16.0

★Taper Connection System is applied to Stopper Block. (Different from the another FA Tooling) ★All types are available with Oil Hole System.
 ★Stopper block is available as an option. When ordering, please inform your M/C maker and Model as well as your M/C spindle flange dimension.
 ★NIT40-AFT30-200 and NIT50-AFT35-230 are also available. ★When M/C spindle rotates CW, the cutter rotates CW.

Quick type 90° Angular Head



AHT



Explanation of the Code No.

NBT40 - AH T 30 - 160 - 90

- Angle
- Length from Gauge Line
- Taper No. of Adapter
- Quick type
- Symbol of Angular Head
- Shank

MAX 2,000 min⁻¹

TAPER	Code No. L -θ	Shank	L	P	l ₁	l ₂	l ₃	C	B	θ	Adapter	Weight(kg)
No.40	NBT40-AHT30-160 -90	NBT40	160	65	58	61	37	86	80	90	AHK30	6.5
	(NIT40) -250* -90	NBT40	250									10.5
No.50	NBT50-AHT35-210 -90	NBT50	210	110	65	88	45	100	90	90	AHK35	17.0
	(NIT50) -300* -90	NBT50	300									22.0

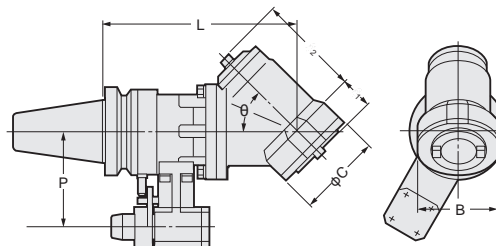
★Taper Connection System is applied to Stopper Block. (Different from the another FA tooling) ★All types are available with Oil Hole System.
 ★Stopper block is available as an option. When ordering, please inform your M/C maker and Model as well as your M/C spindle flange dimension.
 ★Models with * mark : Detailed discussion is needed. ★When M/C spindle rotates CCW, the cutter rotates CW.

Quick type 30°, 45°, 60° Angular Head



AHT

Photo shows 30° type.



Explanation of the Code No.

NBT40 - AH T 30 - 170 - 45

- Angle
- Length from Gauge Line
- Taper No. of Adapter
- Quick type
- Symbol of Angular Head
- Shank

MAX 2,000 min⁻¹

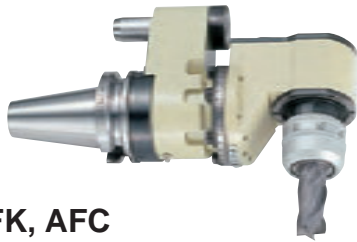
TAPER	Code No. L -θ	Shank	L	P	l ₁	l ₂	C	B	θ	Adapter	Weight(kg)
No.40	NBT40-AHT30-205 -30	NBT40	205	65	1.5	122	86	80	30	AHK30	6.5
	(NIT40) -170 -45		170		35	88			45		6.5
	-160 -60		160		35	88			60		6.5
	-250* -30	NBT40	250	1.5	122	86	80	30	AHK30	10.5	
	-45		65	35	88			45		10.5	
	-60		35	88	60			10.5			
No.50	NBT50-AHT35-258 -30	NBT50	258	110	0	140	100	90	30	AHK35	17.0
	(NIT50) -225 -45		225		26	110			45		17.0
	-210 -60		210		40	105			60		17.0
	-300* -30	NBT50	300	0	140	100	90	30	AHK35	22.0	
	-45		110	26	110			45		22.0	
	-60		40	105	60			22.0			

★Taper Connection System is applied to Stopper Block. (Different from the another FA tooling) ★All types are available with Oil Hole System.
 ★Stopper block is available as an option. When ordering, please inform your M/C maker and Model as well as your M/C spindle flange dimension.
 ★Models with * mark : Detailed discussion is needed. ★When M/C spindle rotates CCW, the cutter rotates CW.

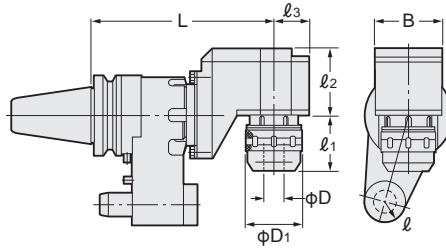
2LOCK SOLID TYPE ANGULAR HEAD (Free Positioning in 360°)

NIKKEN

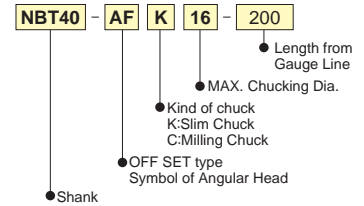
Solid OFF SET type Angular head



AFK, AFC



Explanation of the Code No.



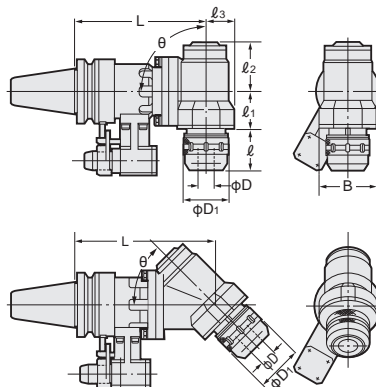
TAPER	Code No. -L	D	D ₁	l ₁	l ₂	l ₃	B	R	min ⁻¹	Weight(kg)	Collet
No.40	NBT40-AFK16-200	2.75~16	40	50	85	35	70	17.5	2,000	8.5	SK 16
	(NIT40)-AFC20-200	2~20	52	56						8.7	KM 20
No.50	NBT50-AFC20-230	2~20	52	58	85	45	84	25	2,000	17.0	KM 20
	(NIT50)-AFC32-230	3~32	69	65						17.2	KM 32

★When M/C spindle rotates CW, the cutter rotates CW.

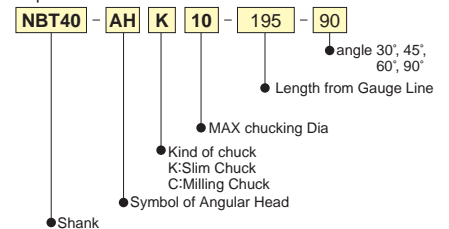
Solid - 90°, 45° type Angular head



AHK, AHC



Explanation of the Code No.



TAPER	Code No. -L -	D	D ₁	l	l ₁	l ₂	l ₃	B	min ⁻¹	Weight(kg)	Collet
No.30	NBT30-AHK10-120-90	1.75~10	27.5	20	49	50	27.5	55	2,000	3.0	SK 10
No.40	NBT40-AHK10-180,220*-90	1.75~10	27.5	18	45	57	32	60	4,000	8.0, 9.0	SK 10
	(NIT40)-AHK16-180,220*-90	2.75~16	40	25	41	58	35	70		8.7, 9.7	SK 16
No.40	-AHC20-160,250*-90	2~20	52	57	58	61	37	80	2,000	7.1, 11.1	KM 20
	NBT50-AHK10-200,240*-90	1.75~10	27.5	18	45	57	32	60	4,000	15.0, 16.0	SK 10
No.50	(NIT50)-AHK16-200,240*-90	2.75~16	40	25	41	58	35	70		15.7, 16.7	SK 16
	No.50	-AHK25-210,300*-90	7.5~25.4	55	57	60	82	45	90	2,000	17.2, 22.2
-AHC32-210,300*-90		3~32	69	17.5, 22.5							KM 32

★Taper Connection System is applied to Stopper Block. (Different from the another FA Tooling) ★All types are available with Oil Hole System.

★Stopper block is available as an option. When ordering, please inform your M/C maker and Model as well as your M/C spindle flange dimension.

★For (SK10) (SK16) (SK25), please refer P.39. For (KM20) (KM25) and (KM32), please refer P.31.

★Angle 30°, 45°, 60° are also available as an option. ★*Mark is for light cutting.

★When M/C spindle rotates CCW, the cutter rotates CW.

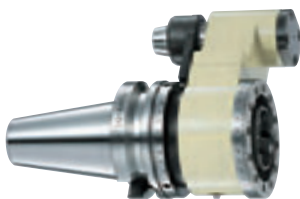
★Please contact with us for the dimension of 30°, 45°, 60° type.

2LOCK MODULAR TYPE ANGULAR HEAD

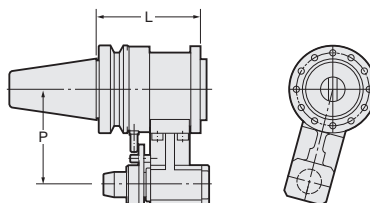
NIKKEN

Modular type Angular Head

AHM



AHM



MAX 6,000 min⁻¹

TAPER	Code No. -L	L	P	Weight(kg)	Suitable Modular Head
No.40	NBT40-AHM-100	100	65	4.5	
No.50	NBT50-AHM-120	120	110	11.5	

★Taper Connection System is applied to Stopper Block.(Different from the another FA Tooling)

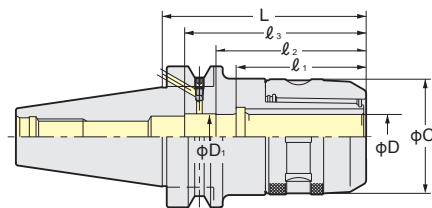
★All types are available with Oil Hole System.

★Stopper block is available as an option. When ordering, please inform your M/C maker and Model as well as your M/C spindle flange dimension.

2LOCK FLANGE THROUGH COOLANT TYPE HOLDER



MILLING CHUCK for Flange Through PAT.



TAPER	Code No.	C ₁	D ₁	l ₁	l ₂	l ₃	Stopper	Collet	Weight(kg)
No.40	NBT40-C20F- 90,105	52	20	58	66	80	9MC20H	CCK20 CCNK20	1.9, 2.0
	-C25F- 90,105	60	25	61	70		9MC25H	CCK25 CCNK25	2.0, 2.2
	-C32F-105,120	69		70	81	107	9MC32H	CCK32 CCNK32	2.5, 2.8
No.50	NBT50-C20F-105,135,165	52	20	58	66	80	9MC20H	CCK20 CCNK20	4.2, 4.4, 4.8
	-C25F-105,135,165	60	61	72	9MC25H		CCK25 CCNK25	4.5, 5.1, 5.7	
	-C32F-120,135,165	69	70	81		107	9MC32H	CCK32 CCNK32	5.1, 5.5, 6.4
	-C42F-120,135,165	86		42	105, 115, 115	125	9MC42H	CCK42 CCNK42	5.8, 6.1, 6.8

★Spanner is available as an option. C20 : 9HC22, C25 : 9HC25
C32 : 9HC32, C42 : 9HC42



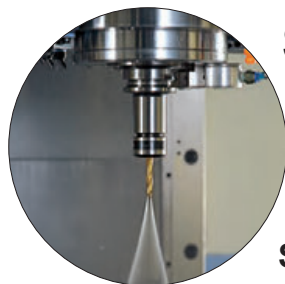
★Shank of High Speed Milling Chuck (G) is **2LOCK** . e.g. NBT40-C20F-105G
GH Handle **P.30** is necessary for High Speed Milling Chuck.

★Please refer **P.161** for CCK Collet and CCNK Collet.

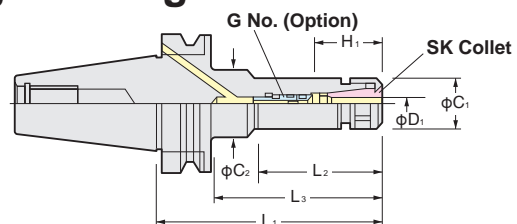
★In case of Heavy End Milling operation, please chuck the End Mill longer than l₁ without using stopper. **P.105**

★Please add "RP" at the end of Code No. for Rust Proof Treatment Milling Chuck. e.g. NBT40-C20F-75-RP.

★Please note the acceptable shank tolerance is h7.



SLIM CHUCK for Flange Through



TAPER	Code No.	D ₁	H ₁	L ₂	L ₃	C ₁	C ₂	G No. (Option)	Weight (kg)	Collet
No.40	NBT40-SK 6F- 90,120	4~6	26~31	51,60	60,90	19.5	32,32	SKG6-6HG	1.1,1.4	SK 6
	-SK10F- 90,120,150,180	5~10	33~41	48,73,73,73	60,90,118,148	27.5	40,40,34.5,39	SKG10-10HG	1.2,1.4,1.6,1.6	SK10
	-SK13F- 90,120,150,180	5~13	39~51	58,88,88,88	- ,118,148	33	- ,40,40	SKG13-10HG	1.4,1.7,1.8,1.8	SK13
	-SK16F- 90	10~16	45~50	58	-	40	-	SKG16-12HGB	1.5	SK16
	-SK16F-120,150,180		45~57	88,118,148				SKG16-12HG	1.7,1.9,2.0	
	-SK20F- 90,120	10~20	57~63,47~63	60,90	-	48.5	-	SKG20-18HGB,SKG20-18HG	1.4,2.0	SK20
	-SK25F- 90,120	16~25	50~58,55~65	61,91				55	SKG25-18HGC,SKG25-24HGA	1.8,2.0
No.50	NBT50-SK 6F-105,165	4~6	26~31	55,60	64,114	19.5	32,32	SKG6-6HG	3.8,4.0	SK 6
	-SK10F-105,165,200,225	5~10	33~41	57,75,75,75	- ,114,151,178	27.5	- ,32,36,40	SKG10-10HG	4.2,4.6,4.8,5.1	SK10
	-SK13F-105,165,200	5~13	39~51	62,92,92	- ,122,157	33	- ,45,45	SKG13-10HG	4.5,4.9,5.2	SK13
	-SK16F-105,165,200	10~16	45~57	62,90,90	- ,122,157	40	- ,50,52	SKG16-12HG	4.7,5.1,5.5	SK16
	-SK20F-105,165	10~20	47~63	62,122	-	48.5	-	SKG20-18HG	4.3,5.0	SK20
	-SK25F-105,165	16~25	55~65,55~70	62,122				55	SKG25-24HGA,SKG25-24HG	5.2,5.6

★Collet, adjust screw (G No.) and spanner are available as an option.

The Code No. of the spanner is SK6F (C=φ18) : SKL-6, SK6F (C=φ19.5) : SKL-6W, SK10F: SKL-10, SK13F: 9HC12A, SK16F: 9HC16, SK20F: 9HC22, SK25F: 9HC25

★Shank of High Speed Slim Chuck (P) is **2LOCK** . e.g. NBT40-SK10F-90P GH Handle **P.30** is necessary for High Speed Slim Chuck.

★Please add "RP" at the end of Code No. for Rust Proof Treatment Slim Chuck. e.g. BT40-SK10F-90-RP.

★Please refer **P.167** for SK Collet.

★When cutter shank dia. is smaller than MIN. of D₁, special adjust screw (G No.) is required. **P.44**



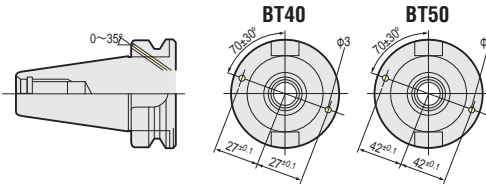
- The special pull stud with Oring is required for the M/C with flange through coolant capability.
- When the stroke of the coolant nozzles at the spindle flange on the M/C with flange through coolant capability is shorter, it may be a collision between flange of **2LOCK** tool and the nozzles. Please check the specification on your M/C.

2LOCK FLANGE THROUGH COOLANT TYPE HOLDER



High Pressure Coolant Through Flange

The Flange Through Coolant System is a solution against the spindle rust and the dust problems of Centre Through Coolant System. These Tool Holder are used for Machine has Flange Through Holes and standard as **DIN69871/B**.



RPT (Rust Proof Treatment) P.106

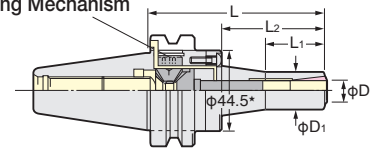
Pull Stud (with O-ring) for Flange Through type is also available.



MINI-MINI CHUCK for Flange Through

30,000min⁻¹ & G2.5
Gripping from Front Nose
Run-out Accuracy: Within 3μm

New Locking Mechanism



High Speed

★ : MMC12 : φ52.4

TAPER	Code No.	φD	φD1	L1	L2	Collet	MAX. min ⁻¹	Weight (kg)
No.40	NBT40-MMC 8F- 90, 120	2~ 8	20	33, 40	42, 72	VMK 8J	30,000	1.4, 1.5
	-MMC12F- 90, 120	4~12	30	36, 60	44, 74	VMK12J		1.7, 1.8
No.50	NBT50-MMC 8F-105, 135, 165	2~ 8	20	33, 40, 40	42, 72, 102	VMK 8J	20,000	4.4, 4.5, 4.6
	-MMC12F-105, 135, 165	4~12	30	36, 60, 70	44, 74, 104	VMK12J		4.6, 4.7, 4.8

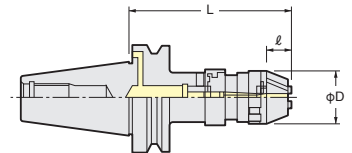
★Wrench is supplied as standard. Collet is available as an option P.33.

★Please use VMK Collet for the cutter with oil hole, and use VMK-J Collet for the cutter without oil hole.

★Photo shows MINI-MINI Chuck & VMK Collet chucking with φ2.7mm oil hole drill.



NPU DRILL CHUCK for Flange Through



TAPER	Code No.	φDmm	φD1	ℓ	L	Weight (kg)
No.40	NBT40-NPU13F-105	6~ 13	48.5	26.5	112.1~123.1	1.9
	150				157.1~168.1	2.4
No.50	NBT50-NPU13F-110	6~ 13	48.5	26.5	117.1~128.1	4.4
	150				157.1~168.1	4.8

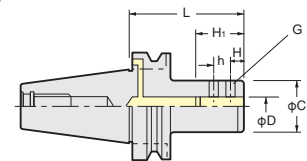
★Wrench is available as an option. NPU8: NPUL-8, NPU13: NPUL-13.

★Please use Slim Chuck P.107 for high pressure coolant (MAX. 7Mpa).

★MIN. Chucking Dia. for center through coolant is φ6mm.



SIDE LOCK HOLDER (for DRILL) for Flange Through



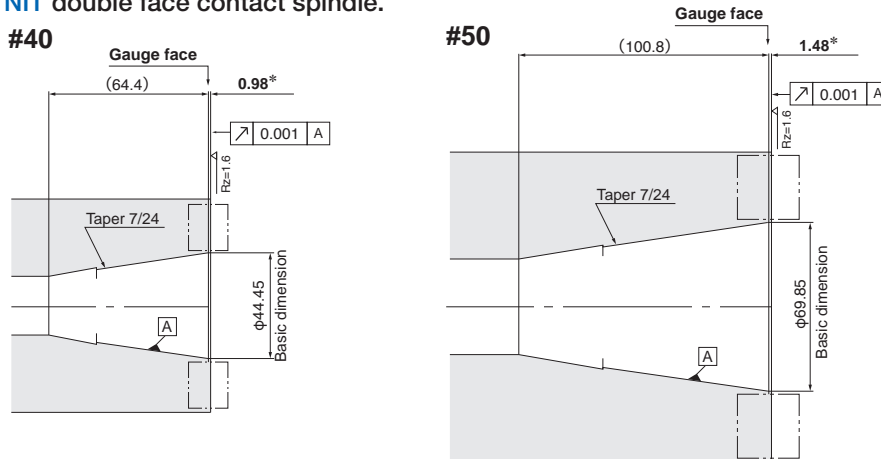
TAPER	Code No.	D	L	C	h	H	H1	G	Collet	Weight (kg)
No. 40	NBT40-SL20F- 90	20	90	50	16	12	44.5	M10	—	1.8
	-SL25F- 90	25	90	55	17	14	54.5	M12 P1.25	OK25	1.7
	-SL32F- 90	32	90	60	16	15	59.5	M12 P1.25	OK32	1.9
No. 50	NBT50-SL20F-105	20	105	50	16	12	44.5	M10	—	4.8
	-SL25F-105	25	105	55	17	14	54.5	M12 P1.25	OK25	4.7
	-SL32F-105	32	105	60	16	15	59.5	M12 P1.25	OK32	4.9
	-SL40F-105	40	105	88	19	18	70	M12 P1.25	OK40	5.2

★For OK25, OK32 and OK40 Collet, please refer P.111.

2LOCK NIT DOUBLE FACE CONTACT SPINDLE



The NIKKEN **3LOCK** tooling can be used as the triple face contact (taper, flange and internal taper expansion) on the M/C with **NIT** double face contact spindle. The NIKKEN **2LOCK** tooling can be used as the double face contact on the M/C with **NIT** double face contact spindle.



* mark: The tolerances of the extension of the spindle flange from gauge face depend on the M/C.



Please be careful to check your M/C specification especially for ATC arm and magazine, when **NIT** tooling is going to use on the M/C with **IT** standard spindle. Because, the flange thickness of **NIT** tooling is 1.7mm (**NIT50**) or 2.2mm (**NIT40**) larger than the thickness of the **IT** standard tooling.

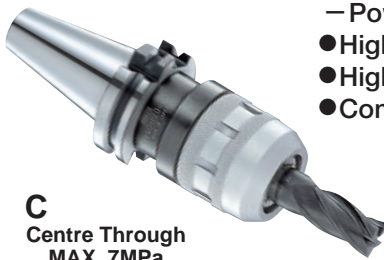
2LOCK NIT MULTI LOCK MILLING CHUCK



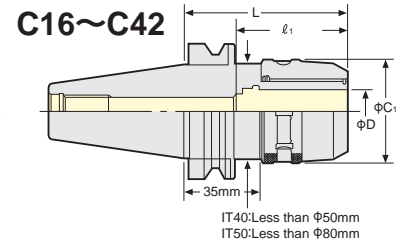
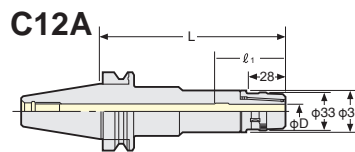
ANNIVERSARY Type

— Powerful gripping torque —

- High rigidity
- High precision
- Compact design



C
Centre Through
MAX. 7MPa



IT40: Less than φ50mm
IT50: Less than φ80mm

TAPER	ITNo. -D -L	Code No.	C ₁	L	l ₁	Collet	Weight (kg)
No.40	NIT40-C12- 65, 90 ^{*1} , 120 ^{*1}		33	65, 90, 120	58	KM12 CCK12	1.3, 1.6, 1.8
	-C16- 60, 90 ^{*1} , 120 ^{*1}		44	60, 90, 120	65	KM16 CCK16	1.4, 1.7, 2.0
	-C20- 80, 90, 105, 120 ^{*2}		52	80, 90, 105, 120	80	KM20 CCK20 CCNK20	1.6, 1.8, 2.0, 2.2
	-C25- 85, 105, 120		60	85, 105, 120	80	KM25 CCK25 CCNK25	2.1, 2.3, 2.5
	-C32- 95, 105, 120		64	95, 105, 120	77, 81, 81	KM32 CCK32 CCNK32	2.1, 2.5, 2.8
No.50	NIT50-C12-105, 135, 165 ^{*1}		33	105, 135, 165	58	KM12 CCK12	4.0, 4.3, 4.6
	-C16-105, 135, 165 ^{*1}		44	105, 135, 165	65	KM16 CCK16	4.2, 4.6, 5.1
	-C20-105, 135, 165, 180 ^{*1}		52	105, 135, 165, 180	80	KM20 CCK20 CCNK20	4.5, 5.1, 5.7, 6.0
	-C25-105, 135, 165		60	105, 135, 165	80	KM25 CCK25 CCNK25	4.8, 5.2, 5.6
	-C32- 85, 105, 120, 135, 165		69	85, 105, 120, 135, 165	81	KM32 CCK32 CCNK32	4.1, 4.6, 5.1, 5.6, 6.4
	-C42- 95 ^{*2} , 105, 135 ^{*1} , 165 ^{*1}		86	95, 105, 135, 165	125	KM42 CCK42 CCNK42	5.2, 5.5, 7.2, 8.6

- ★Spanner is available as an option.
- C12(φ30):9HC12, C12A(φ33):9HC12A, C16:9HC16, C20: 9HC20, C25: 9HC25, C32&φC1=64:9HC25, C32:9HC32, C42:9HC42
- ★Please note the acceptable shank tolerance is h7.
- ★Please refer **P.161** for **KM, CCK, CCNK** Collet.
- ★For heavy duty milling, please grip the end mill shank longer than l_1 .
- ★For Milling Chucks marked ***2**, **NK** Collet, **CCNK** Collet, **ONK** Collet and **OJK** Collet can not be used.
- ★Milling chucks marked ***1** are available as an option.
- ★NIT50-C32-200, 250 and NIT50-C42-200, 250 are also available as an option.
- ★Please add "F" for the flange through tool coolant type.
- NIT40-C20F- 90, 120^{*1} NIT50-C20F-105, 135, 165^{*1}
- C25F- 90, 120^{*1} -C25F-105, 135, 165^{*1}
- C32F-105
- C32F-105, 135, 165
- C42F-120



High Speed Milling Chuck



GH Handle **P.31**

Code No.	MAX. (min ⁻¹)	Code No.	MAX. (min ⁻¹)
NIT40-C12- 65G, 90G	30,000	NIT50-C12-105G, 135G ^{*1}	20,000
-C16- 60G, 90G	25,000	-C16-105G, 135G ^{*1}	
-C20- 80G, 90G	20,000	-C20-105G, 135G ^{*1}	
-C25- 85G		-C25-105G, 135G ^{*1}	
-C32- 95G, 105G	15,000	-C32- 85G, 105G, 120G	
		-C42- 95P ^{*2} , 105P	

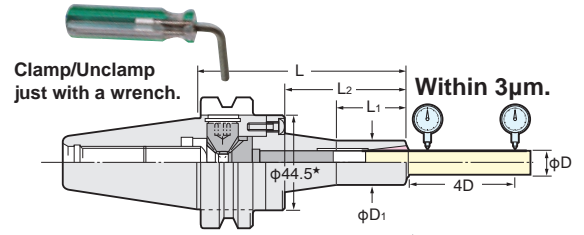
- ★For Milling Chucks except ***2**, Stopper for Direct Chucking, **ONK** Collet and **OJK** Collet can be used.
- ★The extended gauge length (L) is available. Please contact with us.
- ★The end mill shank tolerance is recommended to be h7.

2LOCK NIT MINI-MINI CHUCK

The best chuck for the small dia. cutting tool



MAX. 30,000min⁻¹ & G2.5
Gripping from Front Nose
Run-Out Accuracy:3μm at 4D



MMC

TAPER	Code No.	Chucking Range φD	L	φD ₁	L ₁	Collet	MAX.(min ⁻¹)	Weight(kg)
No.40	NIT40-MMC 4- 90	1~ 4	90	15	30	MPK 4	30,000	1.2
	-MMC 8- 90,120	2~ 8	90,120	20	33,40	PMK 8 VMK 8	30,000	1.4, 1.5
	-MMC12- 90,120	4~12	90,120	30	35,60	PMK12 VMK12	30,000	1.7, 1.8
No.50	NIT50-MMC 4-105	1~ 4	105	15	30	MPK 4	20,000	3.8
	-MMC 8-105,135,165	2~ 8	105,135,165	20	33,40,40	PMK 8 VMK 8	20,000	4.4,4.5,4.6
	-MMC12-105,135,165	4~12	105,135,165	30	35,60,70	PMK12 VMK12	20,000	4.6,4.7,4.8

★Wrench is supplied as standard. ★MPK, PMK, VMK collet is available as an option. Please refer P.33
★Please add "C" for the centre through tool coolant type. e.g. NIT40-MMC8C-90
★Please add "F" for the flange through tool coolant type; NIT40-MMC 8F- 90,120 NIT50-MMC 8F-105,120
-MMC12F- 90,120 -MMC12F-105,120

2LOCK NIT SLIM CHUCK

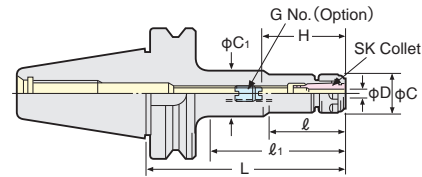
Dampening effect

⊕
Jet Spray Coolant Supply

||
Over 3 times of extended Tool life
(for HSS & Carbide Drills)



SK
Centre Through
MAX. 7MPa



When SK J type nut is used, the total chuck length will be extended by 6mm.

TAPER	Code No.	D	H	ℓ	ℓ ₁	C	C ₁	G No. (Option)	Weight (kg)	SK Collet
No.40	NIT40-SK 6C- 60, 90,120,150	0.7~6.0	26~31	38,48,62,60	-,-,82,112	19.5	-,-,32,25	SKG 6- 6HG	1.0, 1.1, 1.2, 1.4	SK 6
	-SK10C- 60, 90,120,150,180	1.75~10.0	33~41	40,50,60,73,73	-,-,82,112,144	27.5	-,-,32,33.5,39	SKG10-10HG	1.1,1.2, 1.4, 1.6, 1.6	SK10
	-SK13C- 60, 90,120,150,180	2.75~13.0	39~51	40,50,80,88,88	-,-,-,114,144	33	-,-,-,40,40	SKG13-10HG	1.3,1.4, 1.6, 1.8, 1.8	SK13
	-SK16C- 60, 90,120,150,180	2.75~16.0	45~57 ^{*1}	40,54,84,114,144	-	40	-	SKG16-12HG ^{*1}	1.4,1.5, 1.7, 2.0, 2.0	SK16
	-SK20C- 90, 120	4.0~20.0	47~63	70,100	-	48.5	-	SKG20-18HG	1.7, 1.9	SK20
	-SK25C- 90, 120	16.0~25.4	60~70 ^{*2}	70,100	-	55	-	SKG25-24HG ^{*2}	1.8, 2.0	SK25
No.50	NIT50-SK 6C-105,135,165,200	0.7~6.0	26~31	60,62,62,60	-,-,93,117,154	19.5	-,-,32,32,30	SKG 6- 6HG	3.7,3.9,4.1,4.3	SK 6
	-SK10C-105,135,165,200	1.75~10.0	33~41	65,70,75,75	-,-,95,125,154	27.5	-,-,32,32,36	SKG10-10HG	4.2, 4.4, 4.6, 5.0	SK10
	-SK13C-105,135,165,200	2.75~13.0	39~51	60,100,92,102	-,-, 125,160	33	-,-,45,45	SKG13-10HG	4.5, 4.7, 4.8, 5.3	SK13
	-SK16C-105,135,165,200	2.75~16.0	45~57	65,95,90,90	-,-, 125,160	40	-,-,50,50	SKG16-12HG	4.7,4.9, 5.1, 5.5	SK16
	-SK20C-105,135,165	4.0~20.0	47~63	65,95,125	86,116,146	48.5	70.9	SKG20-18HG	4.8,5.1, 5.4	SK20
	-SK25C-105,135,165,200	16.0~25.4	60~70	65,95,125,160	-	55	-	SKG25-24HG	4.8,5.2, 5.6, 6.0	SK25

★Dimension for NIT40-SK16C-60 marked*1, H=45~52 SKG16-10HG
NIT40-SK25C-90 marked*2, H=60~65 SKG25-18HG
★Collet, adjust screw (G No.) and SKL spanner are available as an option.
SK6 (C=φ18):SKL-6, SK6 (C=φ19.5):SKL-6W, SK10:SKL-10, SK13:9HC12A, SK16:9HC16, SK20:9HC22, SK25:9HC22.
★Please refer P.39 for SK collet and please refer P.43 for J type nut.
★Please add "F" for the flange through tool coolant type.
NIT40-SK 6F- 90,120 NIT50-SK 6F-105,165
-SK10F- 90,120 -SK10F-105,165
-SK13F- 90,120 -SK13F-105,165
-SK16F- 90,120 -SK16F-105,165
-SK20F- 90,120 -SK20F-105,165
-SK25F-120 -SK25F-105,165



High Speed SLIM CHUCK



GH Handle P.30

Code No.	MAX. (min ⁻¹)	Code No.	MAX. (min ⁻¹)
NIT40-SK 6C- 60P, 90P, 120P	30,000	NIT50-SK 6C-105P, 165P	20,000
-SK10C- 60P, 90P, 120P		-SK10C-105P, 165P	
-SK13C- 60P, 90P, 120P		-SK13C-105P, 165P	
-SK16C- 60P, 90P, 120P	-SK16C-105P, 165P		
-SK20C- 90P, 120P	25,000	-SK20C-105P, 165P	
-SK25C- 90P, 120P	20,000	-SK25C-105P, 165P	

★The extended gauge length (L) is available. Please contact with us.

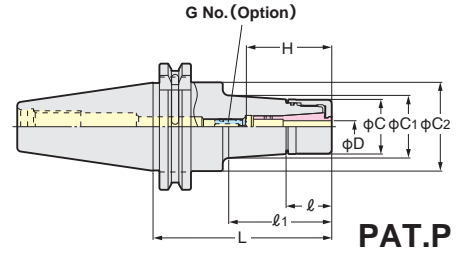
2LOCK NIT ANNIVERSARY TYPE VC HOLDER

NIKKEN



NEW

With TiN Bearing Nut
MAX.30,000min⁻¹ & G2.5
Run-Out Accuracy:3μm at 4D



PAT.P

TAPER	Code No.	D	L	ℓ	ℓ ₁	C	C ₁	C ₂	H	G No. (Option)	Weight (kg)	MAX. (min ⁻¹)	Collet
No.40	NIT40X-VC 6- 60	2.0~6.0	60	23	23	27.5	27.5	44.7	35~45	VCG 6- 8A	1.1	30,000	VCK 6
	- 90		90		51.9		31.5				1.3		
	-120		120		81.9		35.7				1.5		
	-VC13- 60	3.0~12.0	60	29	29	40	40.0	50~60	VCG13-15A	1.2	1.5		VCK13
	- 90		90		70		44.7			1.5			
	-120		120		100		44.7			1.9			
No.50	NIT50X-VC 6-105	2.0~6.0	105	23	64.9	27.5	33.4	70.1	35~45	VCG 6- 8A	3.9	20,000	VCK 6
	-135		135		94.9		37.6				4.1		
	-165		165		124.9		41.8				4.4		
	-VC13-105	3.0~12.0	105	29	64.9	40	45.0	50~60	VCG13-15A	4.1	4.5		VCK13
	-135		135		94.9		49.2			4.5			
	-165		165		124.9		53.4			4.9			

- ★TiN Bearing Nut is supplied as standard.
- ★When the axial stopper is required, please use Adjust Screw(G No.)
- ★Please add “-RP” at the end of Code No. for Rust Proof Treatment VC Holder. e.g. NIT40X-VC13-60-RP
- ★Please use VC J type Nut & Cap for Centre Through Coolant. When VC J type Nut is used, the total holder length will be extended to 6mm.
- ★Please refer P.34 for VCK Collet.

- ★NIT40X-VC6-150, NIT40X-VC13-150, NIT50X-VC13-90, -120 are available as semi-standard.
- ★Collet, adjust screw (G No.) and GH Handle are available as an option. P.30
- The Code No. of the GH Handle is VC6: GH10, VC13: GH16
- ★All series are for High Speed Rotation.



2LOCK NIT MAJOR DREAM HOLDER

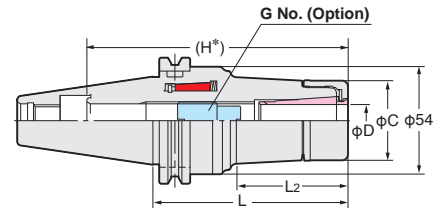
NIKKEN



Difference of the swarfs



Please use Jet Coolant Splash for better swarf generation. P.34, P.43



(H*): MAX. H without adjust screw.

TAPER	Code No.	D	L ₂	C	H*	H ₁	G No. (Option)	Weight (kg)	Collet
No.40	NIT40N-MDSK 6- 60, 75, 90	3.0~ 6.0	18,33,48	19.5	86,101,116	21~35	SKG- 8	0.8,0.9,1.1	SK 6-A
	-105,120		63,78		131,146			1.2,1.4	
	-MDSK10- 60, 75, 90,105	3.0~10.0	19,33,48,63	27.5	86,101,116,131	30~50	SKG-12L	1.1,1.3,1.5,1.6	SK10-A
	-120,150,180		78,110,141.2		146,176,206			1.8,2.2,2.4	
	-MDSK13- 65, 75, 90,105	3.0~13.0	24,33,48,63	33	86,101,116,131	31~60	SKG-15	1.2,1.4,1.7,1.8	SK13-A
	-120,150,180		78,110,144		146,176,206			2.0,2.4,2.6	
	-MDSK16- 65	3.0~16.0	24	40	86	45~60	SKG-18L	1.2	SK16-A
	- 75, 90,105		33,48,64		101,116,131	1.5,1.9,2.0			
	-120,150,180		80,113,144.6		146,176,206	2.2,2.5,2.8			
	-MDSK20- 75, 90	4.0~20.0	41.2,55	48	80,95	50~73	SKG-12,SKG-12-55L	1.9,2.1	SK20-A
-105,120	70,85		110,125		2.3,2.6				
No.50	NIT50 -MDSK 6-105,120,135	3.0~ 6.0	48,63,78	19.5	116,131,146	21~35	SKG- 8	3.6,3.7,3.9	SK 6-A
	-MDSK10-105,120,135	3.0~10.0	48,63,2,78.2	27.5	116,131,146	30~50	SKG-12L	4.3,4.4,4.7	SK10-A
	-165,195		110.2,141.2		176,206			5.0,5.3	
	-MDSK13-105,120,135	3.0~13.0	48,63,78	33	116,131,146	31~60	SKG-15	4.2,4.7,5.0	SK13-A
	-165,195		110,144		176,206			5.3,5.6	
	-MDSK16-105,120,135	3.0~16.0	48,64,80.1	40	116,131,146	45~70	SKG-18L	4.1,4.9,5.2	SK16-A
	-165,195		114.7,144.6		176,206			5.5,5.8	
	-MDSK20-105,135		4.0~20.0		42,72			48	
	-165,195	102,132		205,235	5.9,6.7				
	-MDSK25-105,135	8.0~25.4		42,74	55	159,175	55~85		SKG-28
-165,195	105,135		205,235	6.5,7.5					

- ★Please use A type SK collet that is available as an option for end milling operation. P.167
- ★Please refer P.43 for Jet coolant J type nut and cap.
- ★GH Handle is available as an option. P.30 Please order with the Code No. GH10:MDSK10, GH16:MDSK16, GH20:MDSK20, GH25:MDSK25.
- ★Please add “P” at the end of Code No. for high speed holder, e.g. NIT40N-MDSK10-60P.
- ★φC₂ of NIT40N is larger than the dimension of the IT40 standard.

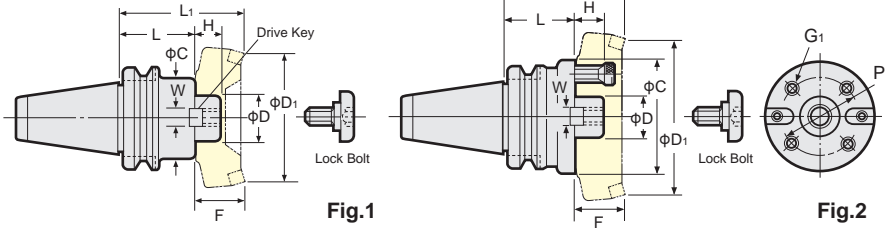


2LOCK NIT FACE MILL ARBOR TYPE A/SHOULDER CUTTER ARBOR



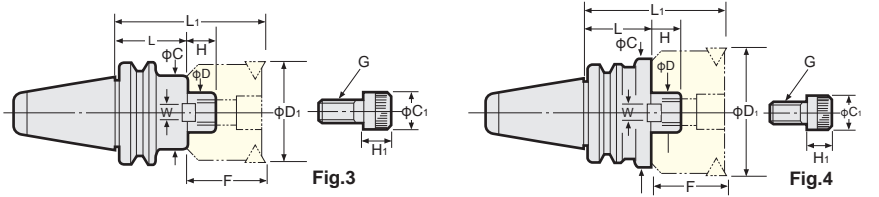
Photo. shows with face mill cutter.

JIS B4113 Face Mill Cutter



FMA

TAPER	Code No. (φD-L)	Arbor			Weight (kg)	With Cutter			Drive Key	Lock Bolt	Fig.
		H	C	W		L ₁	D ₁	F			
No.40	NIT40-FMA25.4 - 45, 90	22	50	9.5	1.5, 3.1	95,140	80	50	FW 5	FM12	1
	-FMA31.75 - 45, 75	30	60	12.7	1.7, 3.1	105,135	100	60	FW13	FM16	
	-FMA38.1 - 60	34	80	15.9	2.9	120	125	60	FW18	FM20	
No.50	NIT50-FMA25.4 - 45, 90, 150	22	58	9.5	3.7, 4.6, 5.5	95,140,200	80	50	FW 5	FM12	1
	-FMA31.75 - 45, 75, 105	30	70	12.7	4.5, 5.3, 6.1	105,135,165	100	60	FW12,13	FM16	
	-FMA38.1 - 45, 75	34	80	15.9	4.3, 5.6	105,135	125	60	FW18,19	FM20	
	-FMA50.8 - 45, 75	36	100	19	4.9, 6.8	105,135	160	60	FW23,24	FM24	
	-FMA47.625- 75*	38	128.57	25.4	7.7	135	200	60	FW26	*	



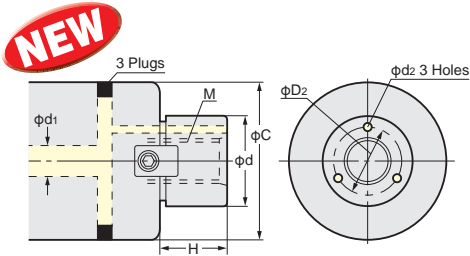
FMC FMA For SANDVIK T-MAX Shoulder Face Mill/SUMITOMO CHE5,000 Series

TAPER	Code No. (φD-L)	Arbor			Weight (kg)	With Cutter			C ₁	H ₁	Fig.	
		H	C	W		L ₁	D ₁	F				G Cap Bolt
No.40	NIT40-FMC22-45, 90	18	45	10	1.3, 2.0	85, 130	50	40	M10×30	16	10	3
	-FMC27-60, 90	20	60	12	1.5, 2.2	110, 140	80	50	M12×35	18	12	4
	-FMC32-60, 75	22	85	14	2.3, 2.6	110, 125	125	50	M16×35	24	16	
No.50	NIT50-FMC22-60, 105, 150	18	45	10	4.2, 4.7, 5.3	100, 145, 190	50	40	M10×30	16	10	3
	-FMC27-45, 90, 150	20	70	12	4.1, 5.5, 7.3	95, 140, 200	80	50	M12×35	18	12	
	-FMC32-45, 75, 105	22	85	14	4.2, 5.5, 7.0	95, 125, 155	125	50	M16×35	24	16	

- ★Drive keys, L wrench and bolt are supplied as standard.
- ★The arbor weight is only for the arbor.
- ★The different type of the cap bolt may be used for the recent cutter. Please check the specification.
- ★The arbor marked * requires 4 fixing bolts (FMA47.625 : M16, P=101.6)
- ★Extended length is available as an option. NIT50-FMA25.4 -200, 250, ...500
-FMA31.75-150, 200, ...500
-FMA38.1 -150, 200, ...500



FMH High Feed Cutter Arbor with Coolant Hole



Code No.	Cutter Dia.	φd	φC	M	H	Coolant Hole		
						φD ₂	φd ₁	φd ₂
FMH22 (22.225)	φ50, φ52 φ63, φ66	22(22.225)	47	M10×1.5	18(17)	16	6~8	3
			60					
FMH27 (25.4)	φ80	27(25.4)	76(70)	M12×1.75	20(22)	19.5(18.5)	8~10	3.5
FMH32 (31.75)	φ100	32(31.75)	96	M16×2.0	22(30)	24	10~13	4
FMH40 (38.1)	φ125	40(38.1)	100	M20×2.5	26(34)	30(29)	10~15	5
FMH50.8	φ160	50.8	100	M24×3.0	36	37.5	15~20	7

- ★Fixing dimension is basically based on FMA/FMC.
- ★The combination of the other cutter dia. are also available.

FMH

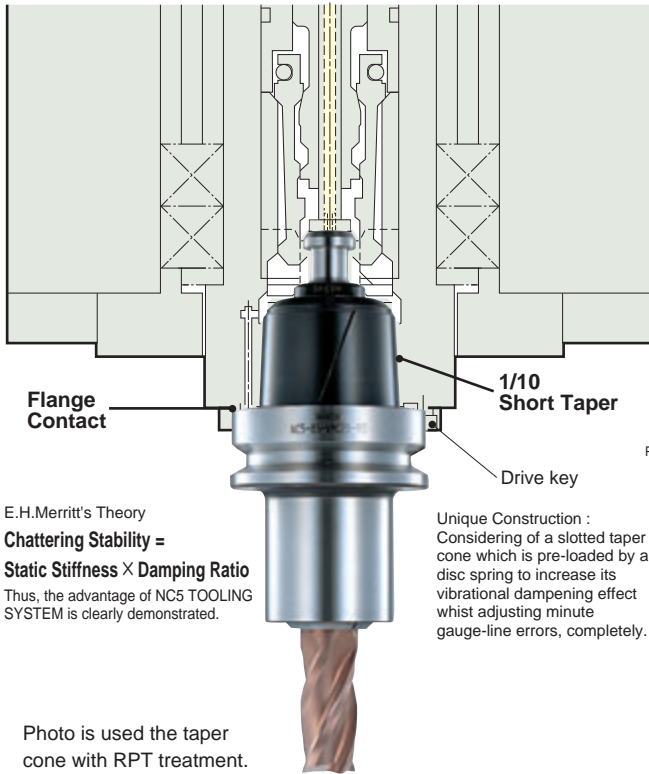
TAPER	Code No. (φD-L)	Arbor						Weight (kg)	Drive Key	Lock Bolt	G Cap Bolt	
		H	C	W	C ₁	C ₂	H ₁					H ₂
No.40	NIT40-FMH22 - 47(60)-45	18	47(60)	10	16	—	10	1.3(1.4)	FW 8	—	M10×30	
	-FMH27 - 60(76)-60	20	60(76)	12	18	—	12	1.8(2.2)	FW11		M12×35	
	-FMH32 - 96-60	22	96	14	24	—	16	2.9	FW16		M16×35	
	-FMH40 -100-60	26	100	16	50	27	14	6	3.1		FW22	FM20
No.50	NIT50-FMH22 - 47(60)-60	18	47(60)	10	16	—	10	4.2(4.5)	FW 8	—	M10×30	
	-FMH27 - 60(76)-45	20	60(76)	12	18	—	12	3.9(4.1)	FW10		M12×35	
	-FMH32 - 96-45	22	96	14	24	—	16	4.2	FW15		M16×35	
	-FMH40 -100-45	26	100	16	50	27	14	6	5.1		FW20	FM20
	-FMH50.8 -100-45	36	100	19	65	37	14	10	4.4		FW23	FM24

- ★FMH22.225, FMH25.4, FMH31.75, FMH38.1 are also available.
- ★For FMH22, there are two types of φC, φ47 and φ60. For FMH27, there are two types of φC, φ60 and φ76.

Innovational Design! Double Contact · 1/10 Short Taper

Since the launch of the NC5 TOOLING SYSTEM at JIMTOF'94, OSAKA the system has proven its outstanding ability is a wide cross-sector of Japanese Industry, with ever-increasing expectation of its being adapted as the Next Generation Tooling Interface.

Please take a moment to look at the NC5 TOOLING SYSTEM before you purchase your next machine. P.263~264



E.H.Merritt's Theory
Chattering Stability =
Static Stiffness × Damping Ratio
Thus, the advantage of NC5 TOOLING SYSTEM is clearly demonstrated.

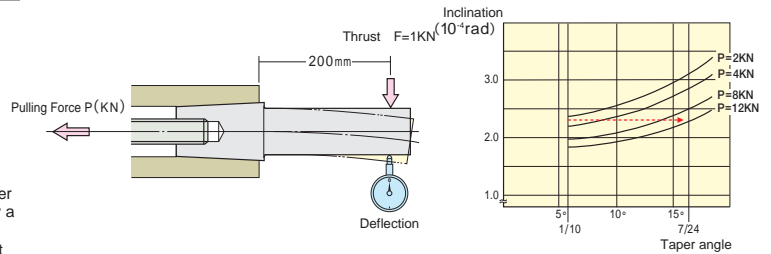
Unique Construction :
Considering of a slotted taper cone which is pre-loaded by a disc spring to increase its vibrational dampening effect whilst adjusting minute gauge-line errors, completely.

Photo is used the taper cone with RPT treatment.

NC5 is an abbreviation of New Century arbor with 1/10 taper (5°43' 29").

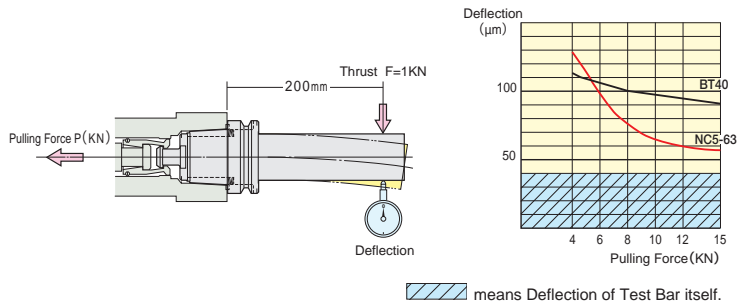
1/10 and 7/24 Taper

The following diagrams show the correlation between Pulling Force/ Taper Angle and their Static Stiffness. As can be seen, using the same Pulling Force, the smaller the Taper Angle, the greater the Static Stiffness. Therefore, the larger the Taper Angle, the greater the Pulling Force is required. For example, 12KN of Pulling Force is required for a 7/24 taper to obtain the same value of Static Stiffness as a 1/10 taper using a 4KN Pulling Force.



Pulling Force and Static Stiffness

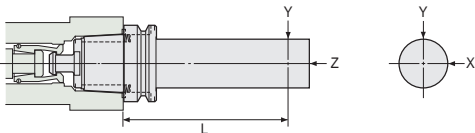
The NC5-63 takes advantage of the taper/Pulling Force to increase its Static Stiffness such that under a force of 5.5 KN the Static Stiffness of an NC5-63 and BT40 are almost the same. But at 12KN the Static Stiffness of an NC5-63 is three times that of a BT40.



means Deflection of Test Bar itself.

Repeatability

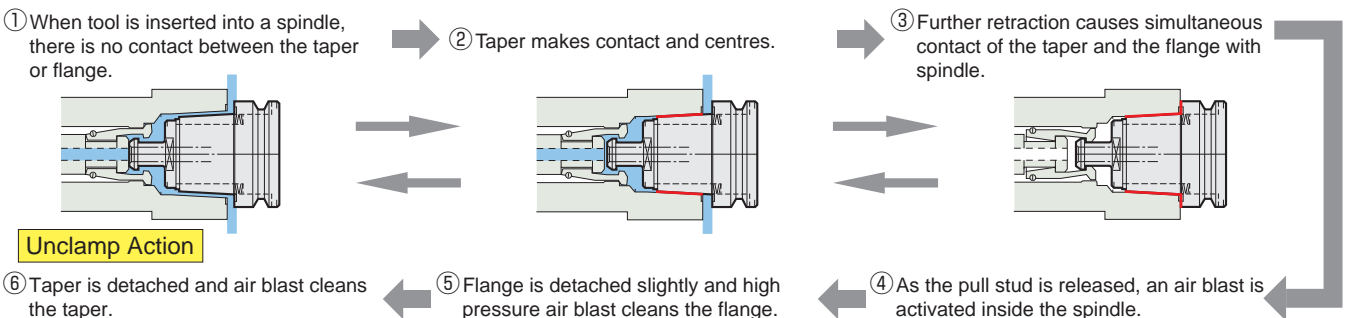
Higher Repeatability is accomplished due to run-out accuracy of contact flange for taper is within 0.002mm.



TAPER	Equivalent	L	Repeatability		
			X	Y	Z
NC5- 46	BT30	70	0.003	0.003	0.002
- 63	BT40	120	0.003	0.003	0.002
- 85	BT45	150	0.003	0.003	0.002
-100	BT50	180	0.003	0.003	0.002

ATC

Clamp Action ... Cleaning Air is same as Unclamp Action.



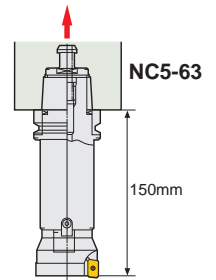
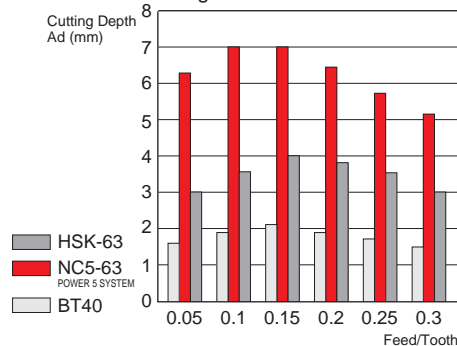
Innovational Design! Double Contact · 1/10 Short Taper

Face Milling



S53C

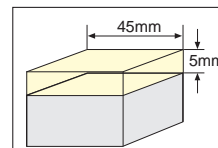
Comparison of Milling Capability using extended cutter



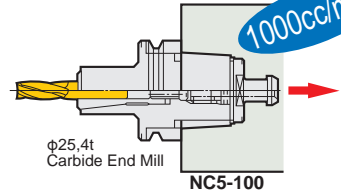
NIKKEN PRO-END MILL PE60H φ60.5t

Material:S53C
V=180m/min. Constant

End Milling



Material:SCM415
V=300m/min. f=0.3mm/tooth
S=3800min⁻¹ F=4560mm/min.



NC5-100

1 to 1 Scale Swarf of SCM415

Stiffness & Dampening Effect

Drilling



SCM435



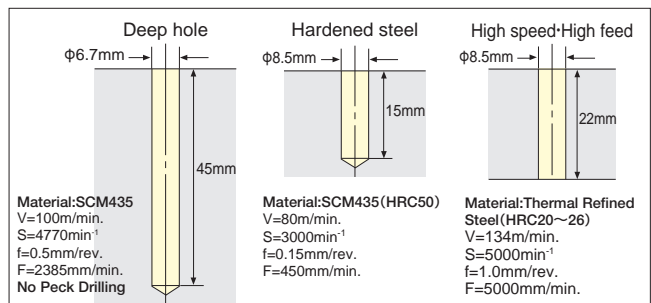
NC5-63

Material:S53C
V=500m/min. f=0.25mm/tooth
S=10000min⁻¹ F=10000mm/min.



NC5-63

Material:TITAN
V=75m/min. f=0.18mm/tooth
S=1500min⁻¹ F=1700mm/min.



Boring



Current developments in inserts (coated TiAlN & CBN) and their improved capability for high speed cutting is remarkable. However, the results are based on using these inserts with high-speed cutting conditions (their performance is reduced when used for medium or low cutting speeds). The ZMAC Boring Head has been designed to optimise this new high-speed cutting technology.

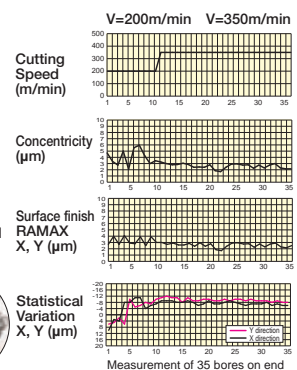
■ Cutting data
M/C : VC8
Holder : NC5-63-Q26-50
SP26-12-30
12-ZMAC16-45
External coolant
Insert : 3MP-C Nose/R=0.2
Coating (Coated TiAlN)

Cutting Speed: V=200m/min, 350m/min.
f=0.05mm/rev. for both
Feed : 0.5mm on dia.

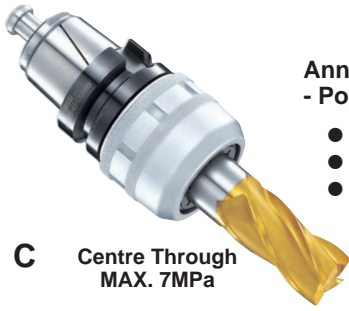
V=350m/min.
gave better
finish & accuracy

Material:S53C Thermal refined carbon steel.

Material:S53C
Thermal refined carbon steel



NC5 MILLING CHUCK

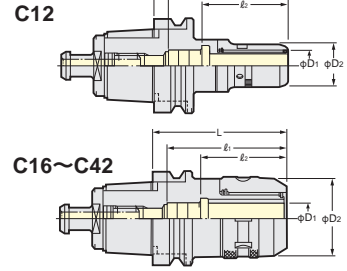


Anniversary Type
- Powerful Gripping Torque -

- High Rigidity
- High Precision
- Compact Design



PAT.



C Centre Through
MAX. 7MPa

TAPER	Code No.	D1	D2	l ₁	l ₂	L	Collet	Stopper	Weight(kg)
NC5- 46	NC5- 46-C12- 55	12	33	56	46	58	(KM12) (CCK12)	—	0.6
	-C16- 70, 120	16	44	63, 65	49	70, 120	(KM16) (CCK16)	—	0.8, 1.2
	-C20- 80	20	52	72	57	80	(KM20) (CCK20) (CCNK20)	9MC20HS	1.0
	-C25- 90	25	60	80	60	90	(KM25) (CCK25) (CCNK25)	9MC25H	1.3
	-C32-100*	32	64	75	66	100	(KM32)	—	1.6
NC5- 63	NC5- 63-C12- 65	12	33	56	46	65	(KM12) (CCK12)	—	1.2
	-C16- 60, 70, 120, 150	16	44	65	49	63, 70, 120, 150	(KM16) (CCK16)	—	1.4, 1.5, 2.0, 2.3
	-C20- 70, 80, 120, 150	20	52	79, 80, 80, 80	57	71, 80, 120, 150	(KM20) (CCK20) (CCNK20)	9MC20H	1.6, 1.7, 2.3, 2.6
	-C25- 70, 90, 120, 150	25	60	80	60	82, 90, 120, 150	(KM25) (CCK25) (CCNK25)	9MC25H	1.9, 2.1, 2.7, 3.0
	-C32- 80*, 90, 120, 150	32	69	71, 77, 81, 81	65, 67, 70, 70	82, 90, 120, 150	(KM32) (CCK32) (CCNK32)	9MC32HS, 9MC32H, 9MC32H	2.1, 2.3, 2.9, 3.2
NC5- 85	NC5- 85-C12- 80	12	33	56	46	80	(KM12) (CCK12)	—	2.2
	-C16- 80, 120, 160	16	44	65	49	80, 120, 160	(KM16) (CCK16)	—	2.6, 3.0, 3.3
	-C20- 80, 120, 160	20	52	80	57	80, 120, 160	(KM20) (CCK20) (CCNK20)	9MC20HL, 9MC20H, 9MC20H	2.8, 3.3, 3.6
	-C25- 80, 120, 160	25	60	80	60	80, 120, 160	(KM25) (CCK25) (CCNK25)	9MC25H	2.9, 3.7, 4.0
	-C32- 85, 100, 160, 200	32	69	81	70	87, 100, 160, 200	(KM32) (CCK32) (CCNK32)	9MC32HS, 9MC32H, 9MC32H, 9MC32H	3.2, 3.6, 5.3, 5.8
	-C42-105*, 125, 160, 200	42	86	93, 113, 125, 125	73	105, 125, 160, 200	(KM42) (CCK42) (CCNK42)	9MC42HS, 9MC42H, 9MC42H	4.8, 5.3, 6.6, 7.0
NC5-100	NC5-100-C12-105	12	33	56	46	105	(KM12) (CCK12)	—	4.1
	-C16-105, 135, 165, 200	16	44	65	49	105, 135, 165, 200	(KM16) (CCK16)	—	4.4, 4.7, 5.0, 5.3
	-C20-105, 165, 200	20	52	80	57	105, 165, 200	(KM20) (CCK20) (CCNK20)	9MC20H	4.6, 5.5, 5.8
	-C25-105, 165, 200	25	60	80	60	105, 165, 200	(KM25) (CCK25) (CCNK25)	9MC25H	5.0, 6.1, 6.4
	-C32- 90, 105, 165, 200	32	69	81	70	90, 105, 165, 200	(KM32) (CCK32) (CCNK32)	9MC32HS, 9MC32H, 9MC32H, 9MC32H	4.8, 5.4, 7.1, 7.5
	-C42- 95*, 115, 165, 200	42	86	105, 125, 125, 125	73	95, 115, 165, 200	(KM42) (CCK42) (CCNK42)	9MC42HS, 9MC42H, 9MC42H	5.5, 6.1, 8.6, 9.0

★For High Speed type, please add "G" at the end of Code No. e.g. NC5-63-C16-60G

★Spanner is available as an option. C12(φ30):9HC12, C12(φ33):9HC12A, C16:9HC16, C20:HC20, C25:9HC25, C32(φ64):9HC25, C32(φ69):9HC32, C42:9HC42

★NC5-63-C32-80 may not be used by the M/C restriction. ★Milling Chuck for Oil Mist is also available. Please contact with us.

★CCNK collet and the stopper can not be used for the chucks marked *. The cutter shank length must be longer than l₂ in case of the direct chucking and centre through coolant application.

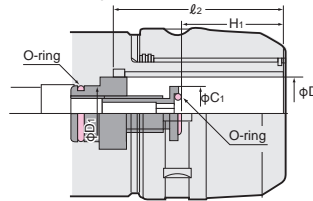
★CCNK collet can be used for the all chucks except marked *. The stopper (optional accessory) is required, if the cutter shank length is shorter than l₂ and direct chucking,

★The "D" in the Code No. shows ID of the chuck. ★Please note the acceptable shank tolerance is h₇. ★Please refer to P.196 for KM, CCK, CCNK Collet.

Stopper for Direct Chucking

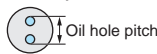
Direct chucking means that chucking φ32mm shank tool into φ32mm ID chuck. If tool shank length is longer than R₁, the stopper is not required.

Chuck	Stopper	H ₁	C ₁
C20C	9MC20H	42~47	17
	9MC20HS		
C25C	9MC25H	50~55	22
C32C	9MC32H	49~59	24
	9MC32HS		
C42	9MC42H	57~67	24



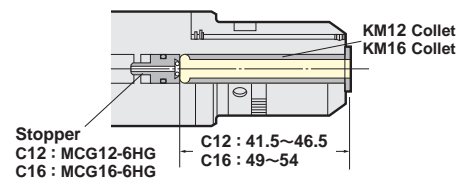
★For heavy milling, please insert the cutter shank longer than l₂ into the chuck body. Do not use the stopper.

★When the oil hole pitch of the back end is larger than the dia. of O-ring, please contact with us.



C12 and C16 Milling Chuck with Special Stopper

C12 and C16 Milling Chucks with the stopper to use with KM Collets are available as special option. e.g. NC5-63-C12-65S, NC5-63-C16-70S



For the types with O-ring on the end flange

add the O-ring type at end of the Code No. e.g. MCG16-6HG-S6

For the steel type, add "FE" at the end of Code No. e.g. MCG16-6HG-FE

High Speed milling Chuck

Please add "G" at the end of Code No. for High Speed Milling Chuck.



GH Handle P.30

★The extended tool length is available as an option. Please contact with us.

★The stopper can not be used for the chucks marked *. The cutter shank length must be longer than l₂ in case of the direct chucking and centre through coolant application.

★All chucks except marked * can be used for high pressure centre through coolant application. The stopper (optional accessory) is required, if the cutter shank length is shorter than l₂ and direct chucking.

TAPER	Code No.	MAX. (min ⁻¹)	TAPER	Code No.	MAX. (min ⁻¹)
NC5-46	NC5- 46-C12- 55G	40,000	NC5-85	NC5- 85-C12- 80G	15,000
	-C16- 70G				
	-C20- 80G	-C25- 80G			
	-C25- 90G	-C32- 85G			
	-C32-100G*	10,000		-C42-105P*	12,000
NC5-63	NC5- 63-C12- 65G	20,000	NC5-100	NC5-100-C12-105G	15,000
	-C16- 60G, 70G				
	-C20- 70G, 80G	-C20-105G			
	-C25- 70G, 90G	-C25-105G			
	-C32- 80G*, 90G	15,000		-C32- 90G	12,000
				-C42- 95P*	

★GFS type P.31 is available for C25 and C32 except NC5-46 shank.

CENTRE COOLANT STRAIGHT COLLET

PAT.



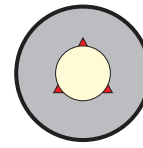
Suitable for all models of the NIKKEN MILLING CHUCK



CCK Collet

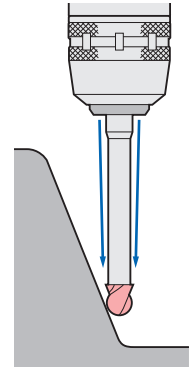


Front Nut

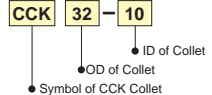


Jet Coolant

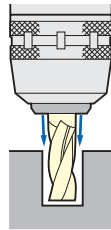
Prevention of Swarf entering the collet through the slots



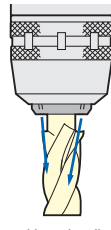
Explanation of the Code No.



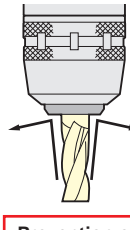
- CCK : Centre Coolant
- CCNK : Centre Coolant, Adjustable
- KM : Standard
- NK : Adjustable
- ONK : Oil Hole Drill
- OJK-A: Jet Coolant
- OJK-S: Multiple Nozzles



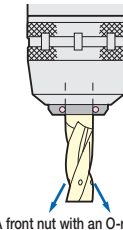
For grooving.



For cutters with cutting diameter which is larger than the shank diameter.



Prevention of the swarf contamination.



A front nut with an O-ring seal, for use with oil hole cutter, is also available as option.



CKFN-MN



CKFN-C

CCK Collet

CKFN front nut and CCKL spanner are available as an option.



Photo shows with front nut.

CCK

Style	CCK Collet Code No. (OD-ID)	Front Nut Code No.
CCK12	CCK12-3, 4, 5, 6, 8, 10	CKFN12
CCK16	CCK16-3, 4, 5, 6, 8, 10, 12	CKFN16
CCK20	CCK20-6, 8, 10, 12, 16	CKFN20
CCK25	CCK25-6, 8, 10, 12, 16, 20	CKFN25
CCK32	CCK32-6, 8, 10, 12, 16, 20, 25	CKFN32, CKFN32T
CCK42	CCK42-6, 8, 10, 12, 16, 20, 25, 32	CKFN42

- ★Above bold figures indicate "ANNIVERSARY" type CCK Collet.
- ★Please note the acceptable shank tolerance is h_6-h_7 .
- ★Other metric sizes and imperial sizes, 1/8, 1/4, 5/16, 3/8, 7/16, 1/2, 5/8, 3/4, 13/16, 7/8, 1, 1-1/8, 1-1/4, 1-1/2" are also available.



Photo shows with front nut.

Cutter length adjustment on the collet is possible from front and back.

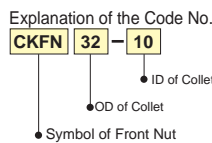
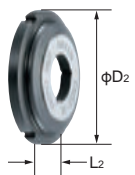
CCNK

Style	CCNK Collet Code No. (OD-ID)	Front Nut Code No.
CCNK20	CCNK20-6, 8, 10, 12, 16	CKFN20
CCNK25	CCNK25-6, 8, 10, 12, 16, 20	CKFN25
CCNK32	CCNK32-6, 8, 10, 12, 16, 20, 25	CKFN32, CKFN32T
CCNK42	CCNK42-6, 8, 10, 12, 16, 20, 25, 32	CKFN42

- ★Please note the acceptable shank tolerance is h_6-h_7 .
- ★Other metric sizes and imperial sizes, 1/8, 1/4, 5/16, 3/8, 7/16, 1/2, 5/8, 3/4, 13/16, 7/8, 1, 1-1/8, 1-1/4, 1-1/2" are also available.

Front Nut

CKFN



Style	φD ₂	L ₂	Front Nut Code No.
CKFN12	19.5	7	CKFN12 -3, 4, 5, 6, 8, 10
CKFN16	28.5	8	CKFN16 -3, 4, 5, 6, 8, 10, 12
CKFN20	33	8	CKFN20 -6, 8, 10, 12, 16
CKFN25	39	8.5	CKFN25 -6, 8, 10, 12, 16, 20
CKFN32	46.5	9	CKFN32 -6, 8, 10, 12, 16, 20, 25
CKFN32T	43	9	CKFN32T -6, 8, 10, 12, 16, 20, 25
CKFN42	59.5	9	CKFN42 -6, 8, 10, 12, 16, 20, 25, 32



- ★The front nut for direct chucking is also available. e.g. CKFN20-20D, CKFN25-25D, CKFN32-32D
- ★The Code No. fitted with O-ring is: e.g. CKFN20-20DC, CKFN25-25DC, CKFN32-32DC

- ★For C32 there are 2 sizes, CKFN32 = for nose ring diameter of φ69mm, CKFN32T = for nose ring diameter of φ64mm.
- ★Jet Coolant type for the cutter with a cutter dia. larger than shank dia. is also available. CKFN25-20MN, CKFN32-25MN, CKFN42-32M
- ★Front Nut fitted with an O-ring is also available. e.g. The Code No. is CKFN32-10C
- ★The spanner is available as an option.
- CKFN12:CCKL12, CKFN16:CCKL16
- CKFN20:CCKL20
- CKFN25, CKFN32T:CCKL25
- CKFN32:CCKL32, CKFN42:CCKL42



KM Photo shows ANNIVERSARY type KM Collet.

Style	KM Collet Code No. (OD-ID)
KM12	KM12-2, 3, 4, 5, 6, 7, 8, 9, 10
KM16	KM16-2, 3, 4, 5, 6, 7, 8, 9, 10, 11, 12
KM20	KM20-2, 3, 4, 5, 6, 7, 8, 9, 10, 11, 12, 13, 14, 15, 16
KM25	KM25-3, 4, 5, 6, 7, 8, 9, 10, 11, 12, 13, 14, 15, 16, 17, 18, 19, 20, 21, 22
KM32	KM32-3, 4, 5, 6, 7, 8, 9, 10, 11, 12, 13, 14, 15, 16, 17, 18, 19, 20, 21, 22, 23, 24, 25, 26, 30
KM42	KM42-3, 4, 5, 6, 7, 8, 9, 10, 11, 12, 13, 14, 15, 16, 17, 18, 19, 20, 21, 22, 23, 24, 25, 26, 27, 28, 29, 30, 31, 32, 40

- ★[For Synchronous Tapping Program] : Special ID Collets for Tap Shank are also available.
- ★Other metric sizes and imperial sizes, 1/8, 1/4, 5/16, 3/8, 7/16, 1/2, 5/8, 3/4, 13/16, 7/8, 1, 1-1/8, 1-1/4, 1-1/2" are also available.
- ★The collets with bold character are the "ANNIVERSARY" type KM Collet.
- Ordinary KM Collet can be used with "ANNIVERSARY" type Milling Chuck, but better performance can be found with the "ANNIVERSARY" type KM Collet.
- ★Please note the acceptable shank tolerance is h_6-h_7 .

Cutter length adjustment on the collet is possible from front and back.

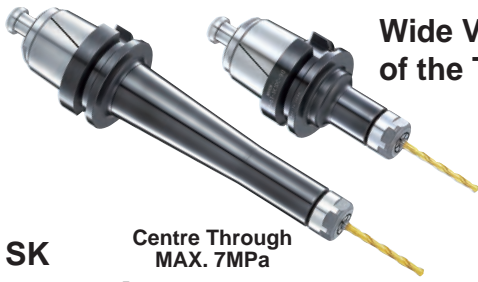


NK

Style	NK Collet Code No. (OD-ID)
NK20	NK20-3, 4, 5, 6, 7, 8, 9, 10, 11, 12, 13, 14, 15, 16
NK22	NK22-3, 4, 5, 6, 7, 8, 9, 10, 11, 12, 13, 14, 15, 16, 17, 18
NK25	NK25-3, 4, 5, 6, 7, 8, 9, 10, 11, 12, 13, 14, 15, 16, 17, 18, 19, 20, 21, 22
NK32	NK32-3, 4, 5, 6, 7, 8, 9, 10, 11, 12, 13, 14, 15, 16, 17, 18, 19, 20, 21, 22, 23, 24, 25, 26
NK42	NK42-3, 4, 5, 6, 7, 8, 9, 10, 11, 12, 13, 14, 15, 16, 17, 18, 19, 20, 21, 22, 23, 24, 25, 26, 27, 28, 29, 30, 31, 32

- ★[For Synchronous Tapping Program] : Special ID Collets for Tap Shank are also available.
- ★Other metric sizes and imperial sizes, 1/8, 1/4, 5/16, 3/8, 7/16, 1/2, 5/8, 3/4, 13/16, 7/8, 1, 1-1/8, 1-1/4, 1-1/2" are also available.
- ★The collets with bold character are standard.
- ★Please note the acceptable shank tolerance is h_6-h_7 .
- ★Collet removal(**9CKR**) is available as an option.
- ★Please refer P.31, P.32 for more detail of the straight collet.

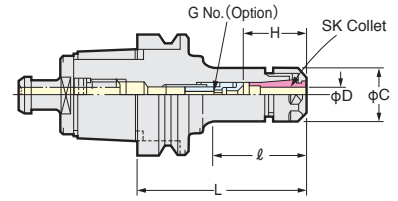
NC5 SLIM CHUCK



Wide Variation
of the Tool Length



Photo. shows
with J type Nut.



SK Centre Through
MAX. 7MPa

When SK J type nut is used, the total chuck length will be extended by 6mm.

JAPAN, USA PAT.

TAPER	Code No.	Chucking Range φD	ℓ	C	H	G No. (Option)	Weight (kg)	SK Collet
NC5- 46	NC5- 46-SK 6C- 75, 90, 120	0.7 ~ 6.0	48, 56, 72	19.5	26 ~ 31	SKG6-6HG	0.4, 0.5, 0.7	SK 6
	-SK10C- 75, 90, 120	1.75 ~ 10.0	50, 65, 95	27.5	35 ~ 41	SKG10-10HG	0.5, 0.6, 0.8	SK 10
	-SK13C- 90, 120	2.75 ~ 13.0	65, 95	33	39 ~ 51	SKG13-10HG	0.7, 0.9	SK 13
	-SK16C- 90, 120	2.75 ~ 16.0	67, 97	40	50	SKG16-10HG	0.8, 1.0	SK 16
	-SK20C- 90, 120	3.5 ~ 20.0		48.5	50~55, 47~63	SKG20-12MFHG, -12HG	1.2, 1.6	SK 20
	-SK25 - 90*1	7.5 ~ 25.4	67	55	55 ~ 60	SKG-12MF	1.2	SK 25
NC5- 63	NC5- 63-SK 6C- 90, 150	0.7 ~ 6.0	51, 60	19.5	26 ~ 31	SKG6-6HG	1.2, 1.4	SK 6
	-SK10C- 90, 150, 200	1.75 ~ 10.0	48, 73, 73	27.5	35 ~ 41	SKG10-10HG	1.4, 1.6, 1.8	SK 10
	-SK13C- 90, 150, 200	2.75 ~ 13.0	58, 88, 88	33	39 ~ 51	SKG13-10HG	1.5, 1.7, 1.9	SK 13
	-SK16C-105, 150, 200	2.75 ~ 16.0	73, 118, 168	40	45 ~ 57	SKG16-12HG	1.6, 2.0, 2.2	SK 16
	-SK20C-105, 150, 200	3.5 ~ 20.0	75, 120, 170	48.5	47 ~ 63	SKG20-18HG	2.0, 2.6, 3.3	SK 20
	-SK25C-135, 180	7.5 ~ 25.4	106, 151	55	60 ~ 65, 60 ~ 70	SKG25-18HGD, 24HG	2.5, 2.8	SK 25
NC5- 85	NC5- 85-SK 6C-105, 150	0.7 ~ 6.0	55, 60	19.5	26 ~ 31	SKG6-6HG	2.3, 2.7	SK 6
	-SK10C-105, 150, 200	1.75 ~ 10.0	70, 73, 75	27.5	35 ~ 41	SKG10-10HG	2.4, 2.8, 3.2	SK 10
	-SK13C-105, 150, 200	2.75 ~ 13.0	67, 92, 92	33	39 ~ 51	SKG13-10HG	2.6, 3.0, 3.4	SK 13
	-SK16C-105, 150, 200	2.75 ~ 16.0	65, 90, 90	40	45 ~ 57	SKG16-12HG	2.7, 3.2, 3.6	SK 16
	-SK20C-135, 165, 200	3.5 ~ 20.0	97, 127, 162	48.5	47 ~ 63	SKG20-18HG	3.5, 3.9, 4.3	SK 20
	-SK25C-135, 165, 200	7.5 ~ 25.4		55	60~65, 60~70, 60~70	SKG25-18HGD, -24HG, -24HG	3.5, 4.0, 4.4	SK 25
NC5-100	NC5-100-SK 6C-105, 165	0.7 ~ 6.0	55, 60	19.5	26 ~ 31	SKG6-6HG	3.9, 4.3	SK 6
	-SK10C-105, 165, 200	1.75 ~ 10.0	57, 75, 75	27.5	35 ~ 41	SKG10-10HG	4.0, 4.4, 4.8	SK 10
	-SK13C-105, 165, 200	2.75 ~ 13.0	62, 92, 92	33	39 ~ 51	SKG13-10HG	4.2, 4.7, 5.1	SK 13
	-SK16C-105, 165, 200	2.75 ~ 16.0	62, 90, 90	40	45 ~ 57	SKG16-12HG	4.3, 5.0, 5.4	SK 16
	-SK20C-135, 165, 200	3.5 ~ 20.0	92, 122, 157	48.5	47 ~ 63	SKG20-18HG	5.1, 5.5, 6.0	SK 20
	-SK25C-135, 165, 200	7.5 ~ 25.4		55	60 ~ 70	SKG25-24HG	5.1, 5.5, 5.9	SK 25

★The "D" of Code No. shows MAX. gripping diameter.

★The "H" dimension is a figure in case of the MAX.gripping diameter.

★All slim chucks except NC5-46-SK25-90 marked *1 are High Pressure Centre Through Coolant type (MAX.7MPa).

★For NC5-46-SK25-90, the adjust screw SKG-12MFH is used for centre through coolant application (1MPa).

The Code No. of the adjust screw for J type nut is SKG-12MF-J.

★For the adjust screws for oil hole taps or smaller dia. cutters, please refer P.44.

★Collet, adjust screw (G No.) and spanner are available as an option.

The Code No. of the spanner is SK6C(C=φ18): SKL-6, SK6C(C=φ19.5): SKL-6W, SK10C: SKL-10, SK13C: 9HC12A, SK16C: 9HC16, SK20C: 9HC22, SK25C: 9HC25

★Please refer P.198 for SK collet and please refer P.43 for J type nut.

SK6C:φ4~φ6, SK10C:φ6~φ10, SK16C:φ10~φ16, SK25C:φ16~φ25

★Slim Chuck for Oil Mist is also available. Please contact with us.

High Speed Slim Chuck

"SK-P" is the Code No. of High Speed Slim Chuck.

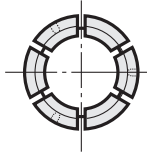
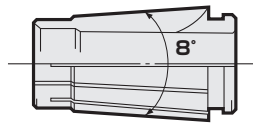


GH Handle P.30

TAPER	Code No.	MAX. (min ⁻¹)	TAPER	Code No.	MAX. (min ⁻¹)
NC5-46	NC5- 46-SK 6C- 75P, 90P, 120P	40,000	NC5-85	NC5- 85-SK 6C-105P, 150P	20,000
	-SK10C- 75P, 90P, 120P			-SK10C-105P, 150P, 200P	
	-SK13C- 90P, 120P			-SK13C-105P, 150P, 200P	
	-SK16C- 90P, 120P	-SK16C-105P, 150P, 200P			
	-SK20C- 90P, 120P	-SK20C-135P, 165P, 200P			
	-SK25 - 90P	-SK25C-135P, 165P, 200P			
NC5-63	NC5- 63-SK 6C- 90P, 150P	30,000	NC5-100	NC5-100-SK 6C-105P, 165P	20,000
	-SK10C- 90P, 150P, 200P	25,000		-SK10C-105P, 165P, 200P	
	-SK13C- 90P, 150P, 200P			-SK13C-105P, 165P, 200P	
	-SK16C-105P, 150P, 200P			-SK16C-105P, 165P, 200P	
	-SK20C-105P, 150P, 200P	20,000		-SK20C-135P, 165P, 200P	
	-SK25C-135P, 180P			-SK25C-135P, 165P, 200P	

SLIM CHUCK COLLET

NIKKEN



Explanation of the Code No.

SK 10 - 6 P

- Non: Standard
- P: P class (Run-out Accuracy=3μm)
- A: A type (for End Mill Shank)
- MAX. Chucking Dia.
- Style No.
- Symbol of SK Collet

SK "A" type SK collet (for End Mill Shank) are marked **●**. The acceptable shank tolerance is h8. Code No. is e.g. SK10-10A
 "P" class SK collet (for drill) are available for all series. e.g. SK10-10P

Code No.	Chucking D
SK 6- 0.8	0.7 ~ 0.8
- 1	0.9 ~ 1.0
- 1.25	1.15~ 1.25
- 1.5	1.3 ~ 1.5
- 1.75	1.55~ 1.75
- 2	1.8 ~ 2.0
- 2.25	2.05~ 2.25
- 2.5	2.3 ~ 2.5
- 2.75	2.55~ 2.75
- 3	2.8 ~ 3.0
- 3.5	3.0 ~ 3.5
- 4	3.5 ~ 4.0
- 4.5	4.0 ~ 4.5
- 5	4.5 ~ 5.0
- 5.5	5.0 ~ 5.5
- 6	5.5 ~ 6.0
SK10- 2	1.75~ 2.0
- 2.25	2.0 ~ 2.25
- 2.5	2.25~ 2.5
- 2.75	2.5 ~ 2.75
- 3	2.75~ 3.0
- 3.5	3.0 ~ 3.5
- 4	3.5 ~ 4.0
- 4.5	4.0 ~ 4.5
- 5	4.5 ~ 5.0
- 5.5	5.0 ~ 5.5
- 6	5.5 ~ 6.0
- 6.5	6.0 ~ 6.5
- 7	6.5 ~ 7.0
- 7.5	7.0 ~ 7.5
- 8	7.5 ~ 8.0
- 8.5	8.0 ~ 8.5
- 9	8.5 ~ 9.0
- 9.5	9.0 ~ 9.5
-10	9.5 ~10.0

Code No.	Chucking D
SK13- 3	2.75~ 3.0
- 3.5	3.0 ~ 3.5
- 4	3.5 ~ 4.0
- 4.5	4.0 ~ 4.5
- 5	4.5 ~ 5.0
- 5.5	5.0 ~ 5.5
- 6	5.5 ~ 6.0
- 6.5	6.0 ~ 6.5
- 7	6.5 ~ 7.0
- 7.5	7.0 ~ 7.5
- 8	7.5 ~ 8.0
- 8.5	8.0 ~ 8.5
- 9	8.5 ~ 9.0
- 9.5	9.0 ~ 9.5
- 10	9.5 ~10.0
- 10.5	10.0~10.5
- 11	10.5~11.0
- 11.5	11.0~11.5
- 12	11.5~12.0
- 12.5	12.0~12.5
- 13	12.5~13.0

Code No.	Chucking D
SK16- 3	2.75~ 3.0
- 3.5	3.0 ~ 3.5
- 4	3.5 ~ 4.0
- 4.5	4.0 ~ 4.5
- 5	4.5 ~ 5.0
- 5.5	5.0 ~ 5.5
- 6	5.5 ~ 6.0
- 6.5	6.0 ~ 6.5
- 7	6.5 ~ 7.0
- 7.5	7.0 ~ 7.5
- 8	7.5 ~ 8.0
- 8.5	8.0 ~ 8.5
- 9	8.5 ~ 9.0
- 9.5	9.0 ~ 9.5
- 10	9.5 ~10.0
- 10.5	10.0~10.5
- 11	10.5~11.0
- 11.5	11.0~11.5
- 12	11.5~12.0
- 12.5	12.0~12.5
- 13	12.5~13.0
- 13.5	13.0~13.5
- 14	13.5~14.0
- 14.5	14.0~14.5
- 15	14.5~15.0
- 15.5	15.0~15.5
- 16	15.5~16.0

Code No.	Chucking D
SK20- 4	3.5 ~ 4.0
- 4.5	4.0 ~ 4.5
- 5	4.5 ~ 5.0
- 5.5	5.0 ~ 5.5
- 6	5.5 ~ 6.0
- 6.5	6.0 ~ 6.5
- 7	6.5 ~ 7.0
- 7.5	7.0 ~ 7.5
- 8	7.5 ~ 8.0
- 8.5	8.0 ~ 8.5
- 9	8.5 ~ 9.0
- 9.5	9.0 ~ 9.5
- 10	9.5 ~ 10.0
- 10.5	10.0~ 10.5
- 11	10.5~ 11.0
- 11.5	11.0~ 11.5
- 12	11.5~ 12.0
- 12.5	12.0~ 12.5
- 13	12.5~ 13.0
- 13.5	13.0~ 13.5
- 14	13.5~ 14.0
- 14.5	14.0~ 14.5
- 15	14.5~ 15.0
- 15.5	15.0~ 15.5
- 16	15.5~ 16.0
- 16.5	16.0~ 16.5
- 17	16.5~ 17.0
- 17.5	17.0~ 17.5
- 18	17.5~ 18.0
- 18.5	18.0~ 18.5
- 19	18.5~ 19.0
- 19.5	19.0~ 19.5
- 20	19.5~ 20.0

Code No.	Chucking D
SK25- 8	7.5~8.0
- 10	9.5~10.0
- 12	11.5~12.0
- 16	15.5~16.0
- 16.5	16.0~16.5
- 17	16.5~17.0
- 17.5	17.0~17.5
- 18	17.5~18.0
- 18.5	18.0~18.5
- 19	18.5~19.0
- 19.5	19.0~19.5
- 20	19.5~20.0
- 20.5	20.0~20.5
- 21	20.5~21.0
- 21.5	21.0~21.5
- 22	21.5~22.0
- 22.5	22.0~22.5
- 23	22.5~23.0
- 23.5	23.0~23.5
- 24	23.5~24.0
- 24.5	24.0~24.5
- 25	24.5~25.0
- 25.4	25.0~25.4

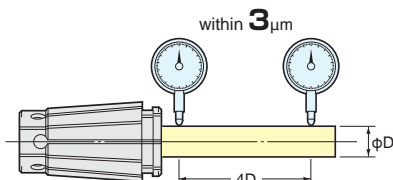
★SK6 collet with the special internal dia. is also available.



Collet removal (SKR-6) is supplied as standard only for SK6. SKR-10, SKR-16 and SKR-25 are available as an option. Collet removal is not necessary for the new types of collet (SK10 to SK25 collet including SK13 and SK20).

■ "P" class SK collet for drill

It guarantees the Run-out accuracy within 3 micron at the nose (4D) from the chuck. Additionally Collet Set is also available.



■ "A" type SK collet for endmill

The acceptable shank tolerance is h8.

SK Collet A type
SK 6-3A, 3.175A, 4A, 5A, 6A
SK10-3A, 3.175A, 4A, 5A, 6A, 8A, 10A
SK13-3A, 4A, 5A, 6A, 8A, 10A, 12A
SK16-3A, 4A, 5A, 6A, 8A, 10A, 12A, 16A
SK20-4A, 5A, 6A, 8A, 10A, 12A, 16A, 20A
SK25-8A, 10A, 12A, 16A, 20A, 25A

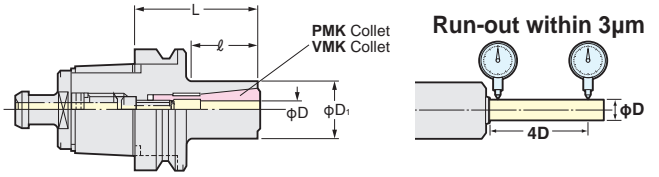
NCS

NC5 VEGA CHUCK



New Innovation for High Speed Milling

The setting of cutter can be done through the centre hole of the pull stud with wrench.



VMC

TAPER	Code No.	Chucking Range φD	D1	ℓ	Collet	MAX. (min ⁻¹)	Collet Removal Jig	Weight (kg)
NC5- 63	NC5- 63-VMC 8- 60, 120N	2~8	22	30, 30	PMK 8, VMK 8J	40,000	VML-63	1.1,1.4
	-VMC12- 65, 120	4~12	30	35, 47	PMK12, VMK12J			1.2,1.7
	-VMC16- 85, 120	4~16	40	53, 88	VMK16, VMK16J			1.4,1.8
	-VMC20- 85, 120	6~20	47	53, 88	VMK20, VMK20J			1.5,2.0
	-VMC25- 90, 120	8~25	55	60, 90	VMK25, VMK25J			1.7,2.3
NC5- 85	NC5- 85-VMC 8- 75N, 135	2~8	22	30, 30	PMK 8, VMK 8J	20,000	VML-85	2.3,2.7
	-VMC12- 75, 135	4~12	30	39, 42	PMK12, VMK12J			2.4,2.9
	-VMC16- 85, 135	4~16	40	47, 57	VMK16, VMK16J			2.5,3.3
	-VMC20- 85, 135	6~20	47	47, 97	VMK20, VMK20J			2.6,3.3
	-VMC25- 90, 135	8~25	55	52, 97	VMK25, VMK25J			2.8,3.6
	-VMC32-110	12~32	70	72	VMK32, VMK32J			3.6
NC5-100	NC5-100-VMC 8- 90N, 150N	2~8	22	30, 30	PMK 8, VMK 8J	20,000	VML-100	4.0,4.5
	-VMC12- 90, 150	4~12	30	49, 60	PMK12, VMK12J			4.1,4.6
	-VMC16- 90, 150	4~16	40	49, 80	VMK16, VMK16J			4.2,4.9
	-VMC20- 85, 150	6~20	47	42, 95	VMK20, VMK20J			4.2,5.3
	-VMC25- 90, 150	8~25	55	47, 107	VMK25, VMK25J			4.3,5.4
	-VMC32-105	12~32	70	57	VMK32, VMK32J			4.9

★The "D" of the Code No. shows MAX. gripping diameter.
★Please add "P" at the end of Code No. for High Speed Chuck. e.g. NC5-63-VMC16-85P.

★Collet and collet removal jig are available as an option.

Collet Removal Jig

VML



Push back the Pull Stud onto the VEGA Chuck and rotate the Chuck to tighten and release. Spanner is available as an option.
NC5-53, NC5-63:9HC22,
NC5-85:9HC32, NC5-100:9HC42



PROTECTION MUST BE USED.



Tightening

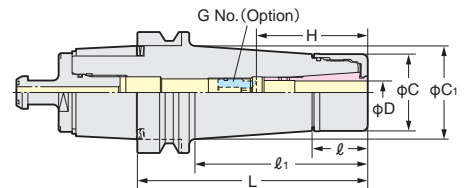
VMK Collet Code No.
VMK 8-2J, 3J, 4J, 5J, 6J, 8J
VMK12-4J, 5J, 6J, 8J, 10J, 12J
VMK16-4J, 5J, 6J, 8J, 10J, 12J, 16J
VMK20-6J, 8J, 10J, 12J, 16J, 20J
VMK25-8J, 10J, 12J, 16J, 20J, 25J
VMK32-12J, 16J, 20J, 25J, 32J

★Please note the acceptable shank tolerance is h.
★VMK8-2J is Jet Spread Hole type.

NC5 ANNIVERSARY TYPE VC HOLDER



With TiN Bearing Nut
MAX.40,000min⁻¹ & G2.5
Run-Out Accuracy:3µm at 4D



PAT.

TAPER	Code No.	D	L	ℓ	ℓ ₁	C	C ₁	H	G No. (Option)	Weight (kg)	MAX. (min ⁻¹)	Collet
NC5- 46	NC5- 46-VC 6- 45, 60, 90	2.0~6.0	45,60,90	23	23,35,65	28	27.5,31.7,33.4	-,-,35~45	-,VCG 6- 8A	0.5,0.6,0.8	40,000	VCK 6
	-VC13- 65, 90, 120	3.0~12.0	65,90,120	29	42,67,97	40	41.8,41.3,42.4	-,-,50~60	-,VCG13-15A	0.8,0.9,1.2		VCK13
NC5- 63	NC5- 63-VC 6- 60, 90, 120	2.0~6.0	60,90,120	23	30,60,90	28	30.0,32.7,36.9	35~45	VCG 6- 8A	1.3,1.5,1.7	30,000	VCK 6
	-VC13- 60, 90, 120	3.0~12.0		29	31,60,90	40	40.3,44.3,48.5	-50~60,50~60	-,VCG13-15A,VCG13-15A	1.4,1.7,2.1		VCK13
NC5- 85	NC5- 85-VC 6-105, 135, 165	2.0~6.0	105,135,165	23	67,97,127	28	33.7,37.8,42.0	35~45	VCG 6- 8A	2.6,2.8,3.1	20,000	VCK 6
	-VC13-105, 135, 165	3.0~12.0		29	40	45.3,49.5,53.7	50~60	VCG13-15A	2.8,3.2,3.6	VCK13		
NC5-100	NC5-100-VC 6-105, 135, 165	2.0~6.0	105,135,165	23	62,92,122	28	33.0,37.1,41.3	35~45	VCG 6- 8A	4.3,4.5,4.9	20,000	VCK 6
	-VC13-105, 135, 165	3.0~12.0		29	40	44.6,48.8,53.0	50~60	VCG13-15A	4.5,4.9,5.3	VCK13		

★Collet, adjust screw (G No.) and GH Handle are available as an option.
The Code No. of the GH Handle is VC6: GH10, VC13: GH16

★When the axial stopper is required, please use Adjust Screw (G No.)

★Please add "-RP" at the end of Code No. for Rust Proof Treatment VC Holder. e.g : NC5-63-VC13-60-RP

★Please use VC J type Nut & Cap for Centre Through Coolant.

When VC J type Nut is used, the total holder length will be extended to 6mm.

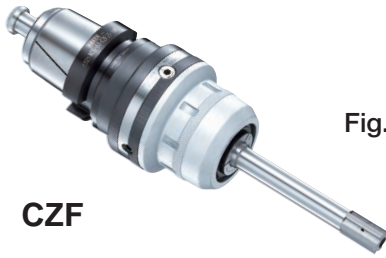
★NC5-63-VC 6-150, NC5-63-VC13-150, NC5-100-VC13- 90, -120 are available as semi-standard.

★All series are for High Speed Rotation.

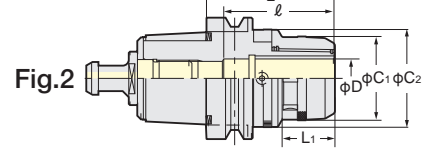
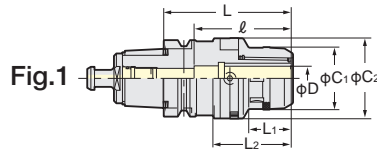
VCK Collet Code No.
VCK 6-2, 3, (3.175), 4, 5, 6
VCK13-3, (3.175), 4, 5, 6, 7, 8, 9, 10, 11, 12

★Please note the acceptable shank tolerance is h.
★Inch size is also available. VCK6-1/8, 3/16, 1/4 VCK13-1/8, 3/16, 1/4, 5/16, 3/8, 7/16, 1/2
★VCK6-3.175 and VCK13-3.175 are same as VCK6-1/8 and VCK13-1/8 respectively.
Please order VCK6-1/8 or VCK13-1/8

NC5 ZERO FIT TYPE MILLING CHUCK



CZF



PAT.

TAPER	Code No.	C1	C2	L	L1	L2	l	Weight(Kg)	Fig.	Collet
NC5- 46	NC5- 46-CZF20-100	51.5	66.5	100	35	68	80	1.4	1	KM20 CCK20
	-CZF25-100	59.5	74.5					1.5		KM25 CCK25
NC5- 63	NC5- 63-CZF20-105	51.5	66.5	105	35	65	80	2.1		KM20 CCK20
	-CZF25-105	59.5	74.5			68		2.4		KM25 CCK25
	-CZF32-120	69	80.5	120	42	81	105	2.9		KM32 CCK32
NC5-100	NC5-100-CZF20-105	51.5	66.5	105	35	-	80	4.9		2
	-CZF25-105	59.5	74.5					5.3	KM25 CCK25	
	-CZF32-105	69	80.5	42	105	5.7	KM32 CCK32			

- ★Spanner is available as an option. CZF20 type:9HC22, CZF25 type:9HC25, CZF32 type:9HC32
- ★Wrench to adjust run-out (9ZFL) is available as an option. ★Please note that the acceptable shank tolerance is $h_6 \sim h_7$.
- ★Please refer P.31, P.32 for KM, CCK collet.
- ★Please add "P" at the end of Code No. for High Speed Zero Fit Milling Chuck. e.g. NC5-63-CZF25-105P
- ★For center through coolant application: Please use CCKFN-D Nut for the direct chucking. Please use CCK collet and CCKFN nut for chucking with collet. P.196
- ★For How to Adjust the Run-Out, please refer P.156

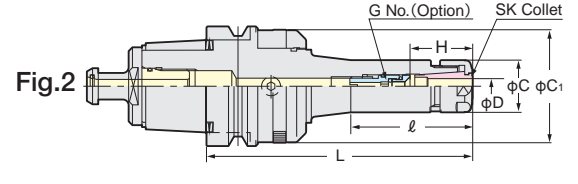
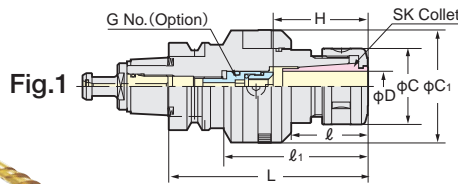
Wrench to adjust
9ZFL



NC5 ZERO FIT TYPE SLIM CHUCK



SZF



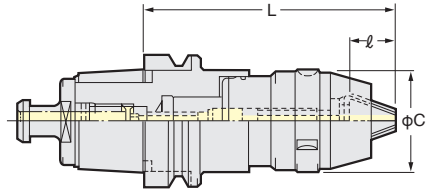
PAT.

TAPER	Code No.	D	L	l	l1	C	C1	H	G No. (Option)	Weight(kg)	Fig.	Collet
NC5- 46	NC5- 46-SZF 6C- 90	0.7~6.0	90	42	-	19.5	40.5	26~31	SKG6-6HG	0.8	2	SK 6
	-SZF10C- 90	1.75~10.0		27	61	27.5	48.5	35~41	SKG10-10HG	1.2	1	SK10
	-SZF16C-120	2.75~16.0		50	86	40	59.5	50	SKG16-10HG	1.7		SK16
NC5- 63	NC5- 63-SZF 6C- 90,150	0.7~6.0	90, 150	37, 60	-	19.5	40.5, 48.5	26~31	SKG6-6HG	1.3, 1.6	2	SK 6
	-SZF10C- 90,150	1.75~10.0		37, 97		27.5	48.5	35~41	SKG10-10HG	1.5, 1.7		SK10
	-SZF16C-105,150	2.75~16.0	105, 150	52, 97	40	59.5	45~57	SKG16-12HG	1.7, 2.0	SK16		
	-SZF25C-135,180	7.5~25.4	135, 180	70, 115	99, 144	55	66.5	60~65	SKG25-18HGD, 24HG	2.6, 2.9		1
NC5-100	NC5-100-SZF 6C-105,165	0.7~6.0	105, 165	41, 63	-	19.5	40.5, 59.5	26~31	SKG6-6HG	4.1, 4.5	2	SK 6
	-SZF10C-105,165	1.75~10.0		41, 101		27.5	48.5	35~41	SKG10-10HG	4.3, 4.7		SK10
	-SZF16C-105,165	2.75~16.0		41, 101		40	59.5	45~57	SKG16-12HG	4.6, 5.3		SK16
	-SZF25C-135,165	7.5~25.4		135, 165		61, 101	55	66.5	60~70	SKG25-24HG		5.5, 5.9

- ★Adjust screw (G No.), wrench to adjust run-out (9ZFL) and SKL spanner are available as an option. SZF6C: SKL-6W, SZF10C: SKL-10, SZF16C: 9HC16, SZF25C: 9HC25
- ★NC5-85 is also available. NC5-85-SZF6C-105, -150 NC5-85-SZF10C-105, -150 NC5-85-SZF16C-105, -150 NC5-85-SZF25C-135, -165
- ★Please use "P" class or "A" type SK collet. P.198. ★Please add "P" at the end of Code No. for High Speed Zero Fit Slim Chuck. e.g. NC5-63-SZF10C-90P
- ★For centre through coolant application, please use SK J type nut and cap. P.43. Please note that the total tool length with J type nut is extended 6mm longer.
- ★For How to Adjust the Run-Out, please refer P.156

NC5

NC5 NPU DRILL CHUCK



NPU

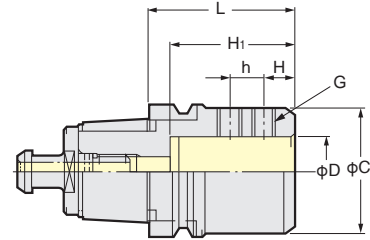
TAPER	Code No.	Chucking Dia. φD	C	ℓ	L MIN.	L MAX.	Weight(kg)
NC5- 46	NC5- 46-NPU 8-100	0.3~ 8	38	18.8	100	104.7	1.0
	-NPU13-120	1 ~13	48.5	26.5	120	131.7	1.4
NC5- 63	NC5- 63-NPU 8- 90	0.3~ 8	38	18.8	90	94.7	1.3
	-NPU13-110	1 ~13	48.5	26.5	110	121.7	1.7
NC5- 85	NC5- 85-NPU 8- 90	0.3~ 8	38	18.8	90	94.7	2.8
	-NPU13-110	1 ~13	48.5	26.5	110	121.7	3.4
NC5-100	NC5-100-NPU 8- 90	0.3~ 8	38	18.8	90	94.7	3.8
	-NPU13-110	1 ~13	48.5	26.5	110	121.7	4.1

★NPU8 can not be used for Centre Through Tool Coolant application.

★Wrench is available as an option. NPU8: NPUL-8, NPU13: NPUL-13.

★Please add "C" to the Code No. for Centre Through Tool Coolant type NPU13(1MPa).
e.g. NC5-63-NPU13C-110

NC5 SIDE LOCK HOLDER



SL

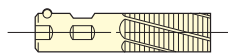
Photo shows the holder with NIKKEN COMBATZ DRILL.

🔧 P.255

SIDE LOCK HOLDER for Drill

TAPER	Code No.	C	h	H	H ₁	G	Weight (kg)
NC5- 63	NC5- 63-SL20C-55	50	—	14	45	M12(P=1.25)	1.4
	-SL25C-60	55	15	11	55		1.6
	-SL32C-70	61	20	12	60		1.7
	-SL40C-80	70	19	15	70		1.8
NC5- 85	NC5- 85-SL20C-70	50	16	12	45	M10(P=1.5)	2.8
	-SL25C-70	55	17	14	55	2.9	
	-SL32C-70	60	15	15	60	M12(P=1.25)	2.8
	-SL40C-80	84	19	18	70	3.7	
NC5-100	NC5-100-SL20C-80	50	16	12	45	M10(P=1.5)	4.2
	-SL25C-80	55	17	14	55	4.4	
	-SL32C-80	60	16	15	60	M12(P=1.25)	4.6
	-SL40C-80	88	19	15	70	5.9	

★All holders are High Pressure Centre Through Tool Coolant type. (7MPa).
The Code No. of SIDE LOCK HOLDER for Combination Shank Cutter is "DM".
e.g. NC5-100-DM50.8-120
NC5- 85-DM50.8-120



SIDE LOCK HOLDER for End Mill

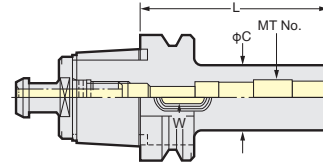
TAPER	Code No.	C	h	H	H ₁	G	Weight (kg)
NC5- 63	NC5- 63-SLS16- 60	48	—	24	60	M14(P=2)	1.4
	-SLS20- 75	52	—	25	70	M16(P=2)	1.7
	-SLS25- 90	63	25	24	75	M18(P=2)	1.9
	-SLS32-105	72	28	24	90	M20(P=2)	2.0
NC5- 85	NC5- 85-SLS16- 70	48	—	24	60	M14(P=2)	2.7
	-SLS20- 70	52	—	25	70	M16(P=2)	3.2
	-SLS25- 95	65	25	24	75	M18(P=2)	3.6
	-SLS32-100	72	28	24	85	M20(P=2)	3.8
NC5-100	-SLS42-115	90	32	30	95	M20(P=2)	4.7
	-SLS50-120	95	35	35	83	M24(P=2)	6.0
	NC5-100-SLS16- 75	48	—	24	60	M14(P=2)	4.0
	-SLS20- 75	52	—	25	70	M16(P=2)	4.5
NC5-100	-SLS25- 75	65	25	24	75	M18(P=2)	4.7
	-SLS32- 75	72	28	24	90	M20(P=2)	4.9
	-SLS42-115	90	32	30	95	M20(P=2)	6.2
	-SLS50-105	98	34.5	35	90	M24(P=2)	7.5

★The above are suitable for JIS B4005 Shank End Mill.

NC5 MORSE TAPER SLEEVE TYPE A



■ For Drill & Reamer
with MT No.1~No.4 Shank.



MTA

TAPER	Code No.	MTNo.	C	W	Weight (kg)
NC5- 46	NC5- 46-MTA1- 85	MT1	25	5.6	0.9
	-MTA2- 95	MT2	32	6.6	1.1
	-MTA3-115	MT3	40	8.4	1.3
NC5- 63	NC5- 63-MTA1- 85	MT1	25	5.6	1.2
	-MTA2- 95	MT2	32	6.6	1.3
	-MTA3-115	MT3	40	8.4	1.6
	-MTA4-140	MT4	50	12.4	2.2

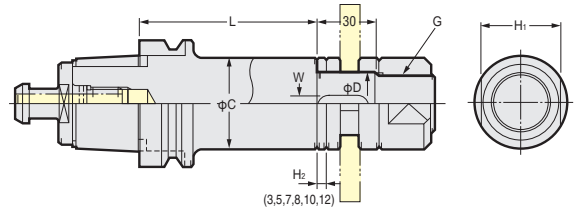
TAPER	Code No.	MTNo.	C	W	Weight (kg)
NC5- 85	NC5- 85-MTA1- 85	MT1	25	5.6	2.6
	-MTA2- 95	MT2	32	6.6	2.7
	-MTA3-115	MT3	40	8.4	3.0
	-MTA4-140	MT4	50	12.4	3.5
NC5-100	NC5-100-MTA1- 85	MT1	25	5.6	4.1
	-MTA2- 95	MT2	32	6.6	4.2
	-MTA3-115	MT3	40	8.4	4.5
	-MTA4-140	MT4	50	12.4	5.1

★The "D" of Code No. shows MT No. ★Please contact with us for the Centre Through Tool Coolant type Sleeve.

NC5 STUB ARBOR



■ No Vibration at slotting.



SCA

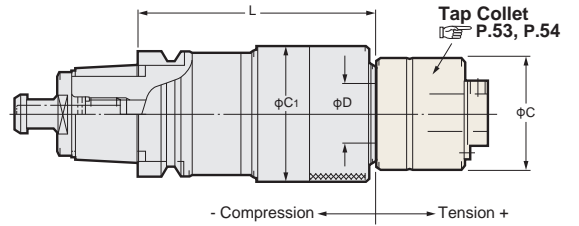
TAPER	Code No. (Inch)	H ₁	C	W	G	Weight (kg)	Code No. (Metric)
NC5- 63	NC5- 63-SCA12.7 -75	17	20	—	M12	1.2	NC5- 63-SCA13-75
	-SCA15.875-75	23	26	3.18(4)	M14	1.4	-SCA16-75
	-SCA22.225-75	29	34	3.18(4)	M20	1.7	-SCA22-75
	-SCA25.4 -75	32	40	6.35(7)	M24	2.0	-SCA27-75
	-SCA31.75 -90	41	46	7.92(8)	M30	2.6	-SCA32-90
NC5- 85	NC5- 85-SCA12.7 -75	17	20	—	M12	2.6	NC5- 85-SCA13-75
	-SCA15.875-90	23	26	3.18(4)	M14	2.8	-SCA16-90
	-SCA22.225-90	29	34	3.18(4)	M20	3.2	-SCA22-90
	-SCA25.4 -90, 135	32	40	6.35(7)	M24	3.5	-SCA27-90
	-SCA31.75 -90, 135	41	46	7.92(8)	M30	3.9	-SCA32-95
NC5-100	NC5-100-SCA12.7 -75	17	20	—	M12	4.0	NC5-100-SCA13-75
	-SCA15.875-90	23	26	3.18(4)	M14	4.2	-SCA16-90
	-SCA22.225-90	29	34	3.18(4)	M20	4.4	-SCA22-90
	-SCA25.4 -90	32	40	6.35(7)	M24	4.5	-SCA27-90
	-SCA31.75 -95, 135	41	46	7.92(8)	M30	4.7	-SCA32-90
	-SCA38.1 -95, 135	46	55	9.52(10)	M36	4.9	-SCA40-90

★The "D" of Code No. shows shaft diameter. ★Guide Key and Collars are supplied as standard. ★The figures in () of W are for Metric.

NC5 TAPPER CHUCK



■ Built-in Floating Mechanism and
Torque-Limiter Mechanism on
Tap Collet.



Z

TAPER	Code No.	Tapping Capability			D	C	C ₁	Tap Collet	Weight (kg)
		M	U	P					
NC5- 63	NC5- 63-Z12- 90	M 2~M12	1/8~1/2	P 1/16~1/4	19	32	45	ZKG12	1.5
	-Z16-120	M 3~M16	1/8~5/8	P 1/8~3/8	25	39	55	ZKG16	2.0
	-Z24-120	M 8~M24	1/2~ 1	P 1/4~5/8	30	46	68	ZKG24	2.1
	-Z38-160	M18~M38	3/8~1 3/8	P 3/8~ 1	45	78	85	ZKN38	6.7
NC5- 85	NC5- 85-Z12-105	M 2~M12	1/8~1/2	P 1/16~1/4	19	32	45	ZKG12	3.3
	-Z16-120	M 3~M16	1/8~5/8	P 1/8~3/8	25	39	55	ZKG16	4.5
	-Z24-120	M 8~M24	1/2~ 1	P 1/4~5/8	30	46	68	ZKG24	4.9
	-Z38-175	M18~M38	3/8~1 3/8	P 3/8~ 1	45	78	85	ZKN38	8.4
	-Z65-195	M36~M100	1~3 3/4	P 1~ 3	68	110(125)	110	ZKN65	8.7
NC5-100	NC5-100-Z12-130	M 2~M12	1/8~1/2	P 1/16~1/4	19	32	45	ZKG12	4.3
	-Z16-135	M 3~M16	1/8~5/8	P 1/8~3/8	25	39	55	ZKG16	5.2
	-Z24-125	M 8~M24	1/2~ 1	P 1/4~5/8	30	46	68	ZKG24	5.8
	-Z38-155	M18~M38	3/8~1 3/8	P 3/8~ 1	45	78	85	ZKN38	8.3
	-Z65-195	M36~M100	1~3 3/4	P 1~ 3	68	110(125)	110	ZKN65	9.0

★Please refer P.53, P.54 for Tap Collet.

★For Synchronized Tapping: ZH Tapper Chuck without tension/compression mechanism is available. It improves tap life remarkably by absorbing fine pitch error completely with the small floating mechanism. Please use ZH Tapper Chuck only with ZMK Tap Collet without torque-limiter mechanism. Please refer P.58.



ZH Tapper Chuck + ZMK Tap Collet

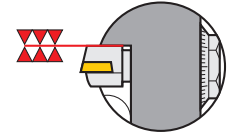
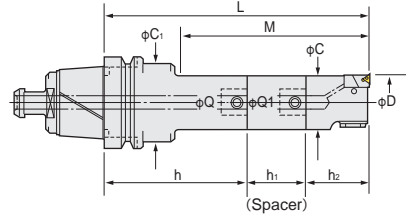
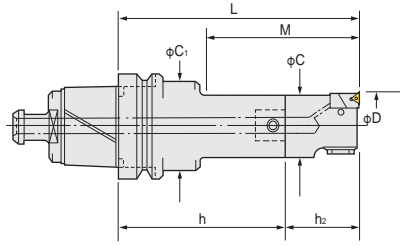
NC5- 63-ZH12- 90 NC5-100-ZH12- 90
-ZH24-105 -ZH24-105
NC5- 85-ZH12- 90
-ZH24-105

NC5 ZMAC BORING ARBOR

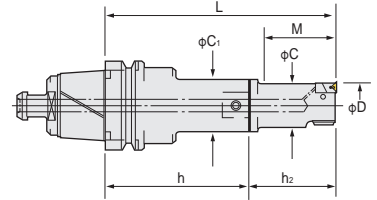


ZMAC

Photo shows ZMAC \times head with A1 spacer.



No Micro Vibration due to Double-Contact Support of Cartridge. Long Tool-Life & High Accuracy.



Only for ZMAC16

All codes shown are for heads with triangular inserts For heads with rhomboid inserts please add the letter "R" to the code No. e.g. NC5-63-ZMAC32 R -150

TAPER	Code No.	Boring Range D	Boring Depth M	P.98		Weight (kg)
				Head No.	Insert No.	
NC5-63	NC5- 63-ZMAC16-125,135	15.9~20.2	38, 48	12-ZMAC16-45,55	3MP-C,B	1.6, 1.6
	-ZMAC20-120,135,150	19.8~25.2	45, 67, 75	9-ZMAC 20- 40		1.6, 1.6, 1.7
	-ZMAC25-120,150,165	24.8~32.2	52, 90, 97	12-ZMAC 25- 40		1.7, 1.8, 1.8
	-ZMAC32-150,180,195	31.8~42.2	77, 110, 122	16-ZMAC 32- 55	4MP-C,B	2.2, 2.4, 2.4
	-ZMAC42-150,180,210	41.8~55.2	97, 130, 157	20-ZMAC 42- 70	6MP-C,B	2.7, 2.9, 3.2
	-ZMAC55-165,210,225	54.8~70.2	135, 180, 195	26-ZMAC 55- 70		3.6, 4.3, 4.3
	-ZMAC70-165,180,225	69.8~85.2	165, 180, 225	34-ZMAC 70- 70		5.1, 5.5, 6.5
	-ZMAC85-195	84.8~100.2	195	42-ZMAC 85-100		8.7
NC5-85	NC5- 85-ZMAC16-140,150	15.9~20.2	38, 48	12-ZMAC16-45,55	3MP-C,B	2.9, 2.9
	-ZMAC20-150,165,180	19.8~25.2	45, 67, 75	9-ZMAC 20- 40		3.0, 3.0, 3.1
	-ZMAC25-135,165,180	24.8~32.2	52, 90, 97	12-ZMAC 25- 40		
	-ZMAC32-180,210,225	31.8~42.2	77, 110, 122	16-ZMAC 32- 55	4MP-C,B	3.7, 3.8, 3.9
	-ZMAC42-180,195,225,240	41.8~55.2	97, 130, 142, 157	20-ZMAC 42- 70	6MP-C,B	4.2, 4.2, 4.6, 4.7
	-ZMAC55-210,240,270	54.8~70.2	117, 182, 177	26-ZMAC 55- 70		5.7, 5.8, 7.3
	-ZMAC70-240,270,300	69.8~85.2	190, 220, 250	34-ZMAC 70- 70		8.2, 8.8, 9.7
	-ZMAC85-225,290,315	84.8~100.2	187, 252, 277	42-ZMAC 85-100		10.7, 13.2, 14.2
	-ZMAC100-225,290,315	99.5~140.5	225, 290, 315	42-ZMAC100-100		12.0, 14.7, 14.6
	-ZMAC140-225,290,315	139.5~180.5		42-ZMAC140-100		12.8, 15.5, 16.2
NC5-100	NC5-100-ZMAC16-140,150	15.9~20.2	38, 48	12-ZMAC16-45,55	3MP-C,B	3.9, 3.9
	-ZMAC20-150,165,180	19.8~25.2	45, 67, 75	9-ZMAC 20- 40		4.0, 4.0, 4.1
	-ZMAC25-135,165,180	24.8~32.2	52, 90, 97	12-ZMAC 25- 40		
	-ZMAC32-180,210,225	31.8~42.2	77, 110, 122	16-ZMAC 32- 55	4MP-C,B	4.7, 4.8, 4.9
	-ZMAC42-180,195,225,240	41.8~55.2	97, 130, 142, 157	20-ZMAC 42- 70	6MP-C,B	5.2, 5.2, 5.6, 5.7
	-ZMAC55-210,240,270	54.8~70.2	117, 182, 177	26-ZMAC 55- 70		6.7, 6.8, 8.3
	-ZMAC70-240,270,300	69.8~85.2	190, 220, 250	34-ZMAC 70- 70		9.2, 9.8, 10.7
	-ZMAC85-225,290,315	84.8~100.2	187, 252, 277	42-ZMAC 85-100		11.7, 14.2, 15.2
	-ZMAC100-225,290,315	99.5~140.5	225, 290, 315	42-ZMAC100-100		13.0, 15.7, 15.6
-ZMAC140-225,290,315	139.5~180.5	42-ZMAC140-100		13.8, 16.5, 17.2		

★MIN. dial readout : ZMAC25 & smaller is 0.02mm on diameter. ZMAC32 and larger are 0.01mm on diameter.

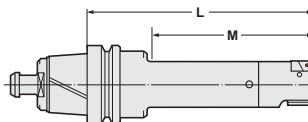
★"C" grade (Coated) insert for Steel, Stainless & Cast Iron is supplied as Standard with the head (Smooth boring & Long tool-life).

We would recommend "B" grade (CBN) insert for Hardened Steel & High Speed boring of Cast Iron. Please refer P.96 for cutting condition.

★Please refer P.206 for Shank, and P.86 for Spacer, and P.77 for Head.

★For Centre Through Tool Coolant type, please add "C" at the end of Code No. e.g. NC5-63-ZMAC55-165C.

★When L length is required longer than standard, please specify boring depth M.



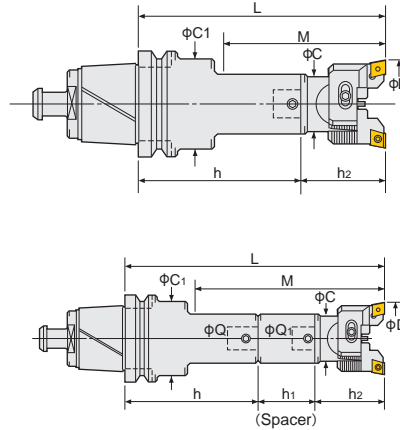
High Speed Boring ZMAC \times P.78

NC5 BALANCE-CUT BORING ARBOR

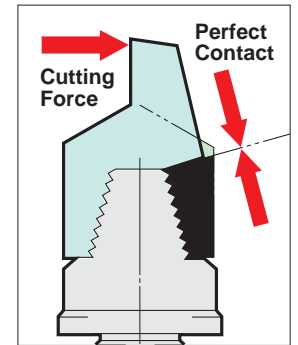


RAC

Photo shows RAC head with A1 spacer.



Power of Shoulder Support



TAPER	Code No.	Boring Range D	Boring Depth M	P.62		Weight (kg)
				Head No.	Insert No.	
NC5-63	NC5- 63-RAC 25-135E, 165E, 180E	25~32	67, 105, 112	12-RAC025- 55E	CC07-C	1.7, 1.8, 1.8
	-RAC 32-150E, 180E, 195E	32~45	77, 110, 122	16-RAC 32- 55E	CC08-C	2.1, 2.3, 2.3
	-RAC 43-150E, 180E, 210E	43~55	97, 130, 157	20-RAC 43- 70E	CC12-C	2.4, 2.6, 2.9
	-RAC 53-165E, 210E, 225E	53~70	135, 180, 195	26-RAC 53- 70E		2.2, 3.0, 2.9
	-RAC 70-180E, 195E, 240E	70~100	180, 195, 240	34-RAC 70- 85E		4.5, 4.9, 5.9
	-RAC100-195E	100~130	195	42-RAC100-100E		6.5
NC5-85	NC5- 85-RAC 25-150E, 180E, 195E	25~32	67, 105, 112	12-RAC 25- 55E	CC07-C	2.9, 3.1, 3.0
	-RAC 32-180E, 210E, 225E	32~45	77, 110, 122	16-RAC 32- 55E	CC08-C	3.6, 3.8, 3.8
	-RAC 43-180E, 195E, 225E, 240E	43~55	97, 130, 142, 157	20-RAC 43- 70E	CC12-C	3.9, 4.0, 4.3, 4.4
	-RAC 53-210E, 240E, 270E	53~70	117, 182, 177	26-RAC 53- 70E		5.1, 5.2, 5.8
	-RAC 70-255E, 285E, 315E	70~100	205, 235, 265	34-RAC 70- 85E		7.7, 8.1, 9.1
	-RAC100-225E, 290E, 315E	100~130	187, 252, 277	42-RAC100-100E		10.7, 10.7, 14.1
NC5-100	NC5-100-RAC 25-150E, 180E, 195E	25~32	67, 105, 112	12-RAC 25- 55E	CC07-C	3.9, 4.1, 4.0
	-RAC 32-180E, 210E, 225E	32~45	77, 110, 122	16-RAC 32- 55E	CC08-C	4.6, 4.8, 4.8
	-RAC 43-180E, 195E, 225E, 240E	43~55	97, 130, 142, 157	20-RAC 43- 70E	CC12-C	4.9, 5.0, 5.3, 5.4
	-RAC 53-210E, 240E, 270E	53~70	117, 182, 177	26-RAC 53- 70E		6.1, 6.2, 6.8
	-RAC 70-255E, 285E, 315E	70~100	205, 235, 265	34-RAC 70- 85E		8.7, 9.1, 10.1
	-RAC100-225E, 290E, 315E	100~130	225, 290, 315	42-RAC100-100E		11.7, 11.7, 15.1

★"C" grade (Coated) inserts are supplied as standard with the head. P.62 Please refer P.93 for cutting condition.

★Please refer P.206 for base holder, P.86 for spacer and P.67 for head.

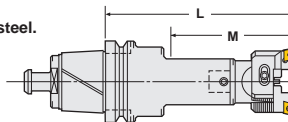
★For centre through tool coolant type, please add "C" at the end of Code No. e.g. NC5-63-RAC53-165-C

★Cartridges & Insert tips for the Heavy Duty Boring of Iron and Cast Iron (No letter), for Aluminum (A), and for Through Hole & Multiple Sheets (K) are available. Please refer P.69 for cartridges. Please add the letter "No letter", "A" or "K" at the end of Code No. e.g. NC5-63-RAC53-165A

★When L length is required longer than standard, please specify the boring depth M.

★Cartridge & Insert for Alloy Steel (E) is recommended for boring on steel and stainless steel. e.g. NC5-63-RAC53-165E

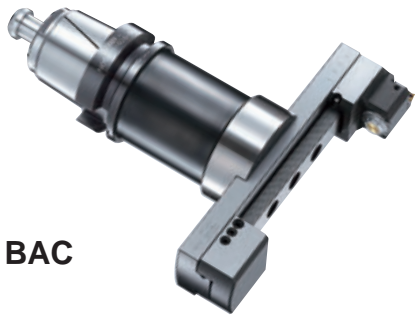
Code No. of RAC25 and RAC32 with CC inserts are changed to RAC25E and RAC32E. Please refer P.61, P.62



High Pressure Coolant Through

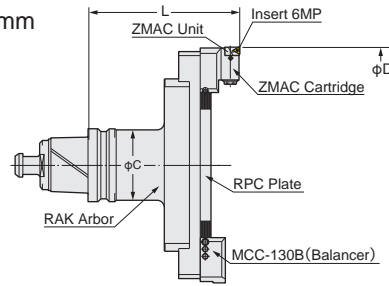
NC5 BALANCE-CUT BAC BORING ARBOR for LARGE DIA.

NIKKEN



BAC

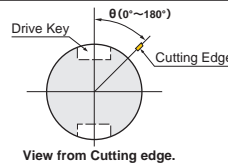
- Min. dial read out: main scale dia. 0.02mm, sub scale dia. 0.002mm
- Boring Dia: $\phi 130 \sim 595\text{mm}$



Boring Dia: $\phi 130 \sim 595\text{mm}$ for Finishing.

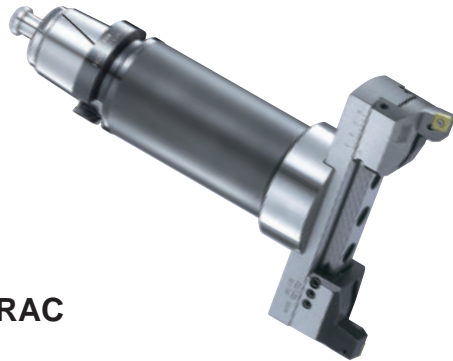
TAPER	Code.No	D	L	C	Arbor No.	RPC Plate No	Cartridge (Balancer)	Weight (kg)
		MIN.~MAX.						
NC5- 63	NC5-63 -BAC130-205	130~195	205	61	NC5-63-RAK-130	RPC-130	MCCZ-130 (MCC-130B)	6.8
	-BAC180-205	180~245				-180		7.8
NC5- 85 NC5-100	NC5-85 (NC5-100) -BAC130-185, 235, 285	130~195	185, 235, 285	90	NC5-85-RAK-110, 160, 210 (NC5-100)	RPC-130	Insert Tip 6MP	13.0, 14.5, 17.5
	-BAC180-185, 235, 285	180~245				-180		13.5, 15.0, 18.0
	-BAC230-185, 235, 285	230~295				-230		14.0, 15.5, 18.5
	-BAC280-185, 235, 285	280~345				-280		14.5, 16.0, 19.0
	-BAC330-210	330~395	210	98	NC5-85-RAK330-125 (NC5-100)	RPC-330		16.2
	-BAC380-210	380~445				-380		16.5
	-BAC430-210	430~495				-430		17.5
	-BAC480-210	480~545				-480		18.5
-BAC530-210	530~595	-530	19.5					

- ★ "C" grade (Coated) Inserts are supplied as standard.
- ★ Arbor, Plate and Cartridge are delivered in separate packages.
- ★ When ordering, please let us know machine maker and model no. to avoid the interference with tool magazine of ATC.
- ★ The location of cutting edge is same as drive key in standard. The different location is available, please specify θ in Code No. e.g. NC5-100-BAC180-235 (90°)



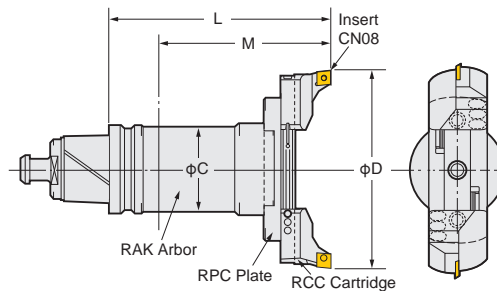
NC5 BALANCE-CUT BAC BORING ARBOR for LARGE DIA.

NIKKEN



RAC

- With slight adjust screw
- Boring Dia: $\phi 130 \sim 580\text{mm}$



High Pressure Coolant Through Tool is available.

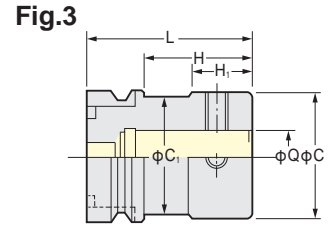
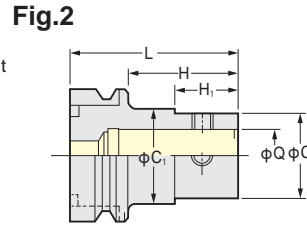
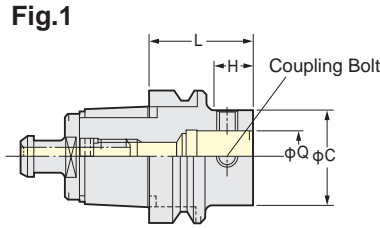


Boring Dia: $\phi 130 \sim 580\text{mm}$ for Roughing.

TAPER	Code.No	D	L	C	Arbor No.	RPC Plate No.	Cartridge No. for Large dia.	Weight (kg)	
		MIN.~MAX.							
NC5- 63	NC5-63 -RAC130-205	130~180	205	61	NC5-63-RAK-130	RPC-130	For Heavy Duty Boring of Iron and Cast Iron	6.8	
	-RAC180-205	180~230				-180		7.8	
NC5- 85 NC5-100	NC5-85 (NC5-100) -RAC130-185, 235, 285	130~180	185, 235, 285	90	NC5-85-RAK-110, 160, 210 (NC5-100)	RPC-130	RCC-130 x2	11.3, 12.8, 15.8	
	-RAC180-185, 235, 285	180~230				-180		11.8, 13.3, 16.3	
	-RAC230-185, 235, 285	230~280				-230		12.3, 13.8, 16.8	
	-RAC280-185, 235, 285	280~330				-280		12.8, 14.3, 17.3	
	-RAC330-210	330~380	210	98	NC5-85-RAK330-125 (NC5-100)	RPC-330		Insert Tip CN08	15.5
	-RAC380-210	380~430				-380			16.5
	-RAC430-210	430~480				-430			17.5
	-RAC480-210	480~530				-480			18.5
-RAC530-210	530~580	-530	19.5						

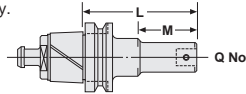
- ★ The Code No. on above table are the boring arbors with RCC-130 cartridge (Insert tip: CN08) the Heavy Duty Boring of Iron and Cast Iron. Please refer P.95 for cutting condition.
- ★ Boring arbor with cartridges & insert for Steel, Stainless Steel and Cast Iron (E), for Aluminum (A) and for Through Hole & Multi Sheets (K) are available. Please refer P.72 for cartridges. e.g. NC5-100-RAC130-185E
- ★ When ordering, please let us know machine maker and model no. to avoid the interference with tool magazine of ATC.
- ★ Arbor, Plate and Cartridge are delivered in separate packages. ★ The location of cutting edge is same as drive key in standard. The different location is available, please specify θ in Code No. e.g. NC5-100-RAC180-235 (90°)

NC5 MODULAR TYPE BASE HOLDER



TAPER	Code No.	Coupling Dia Q	L	C	C ₁	H	H ₁	Coupling Bolt No.	Fig.	Weight(kg)
NC5- 46	NC5- 46-Q26- 40	26	40	50	45	18	6	B26N	3	0.4
	NC5- 63-Q 9- 80, 95	9	80, 95	19	30	48, 63	5, 27	B19	2	1.6, 1.7
NC5- 63	-Q12- 80, 110	12	80, 110	24	35	48, 78	12, 50	B12		1.6, 1.7
	-Q16- 95, 125	16	95, 125	31	42	63, 93	22, 55	B16		1.9, 2.1
	-Q20- 80, 110	20	80, 110	40	50	48, 78	27, 60	B20		2.0, 2.2
	-Q26- 50, 95, 140	26	50, 95, 140	50	—	20, 65, 110	—	B26N		0.9, 1.5, 2.3
	-Q34- 95, 110	34	95, 110	64	62	68, 83	55, 70	B34		3.0, 3.4
-Q42- 95	42	95	83	62	68	55	B42	3.6		
NC5- 85	NC5- 85-Q 9-110, 125	9	110, 125	19	40	72, 87	5, 27	B19	2	2.9, 3.1
	-Q12- 95, 125	12	95, 125	24	44	57, 87	12, 50	B12		2.5, 3.2
	-Q16-125, 155	16	125, 155	31	50	87, 117	22, 55	B16		3.6, 3.8
	-Q20-110, 125	20	110, 125	40	60	72, 87	27, 60	B20		3.7, 3.8
	-Q26- 65, 140, 170	26	65, 140, 170	50	65	27, 102, 132	—, 40, 110	B26N	2.5, 4.6, 4.7	
	-Q34-140, 170, 200	34	140, 170, 200	64	80	102, 137, 167	—, 117, 147	B34	4.5, 6.4, 6.8	
	-Q42-125, 190	42	125, 190	83	—	87, 152	—	B42	8.0	
NC5-100	NC5-100-Q 9-110, 125	9	110, 125	19	40	67, 82	5, 27	B19	2	4.0, 4.2
	-Q12- 95, 125	12	95, 125	24	44	52, 82	12, 50	B12		4.1, 4.3
	-Q16-125, 155	16	125, 155	31	50	82, 112	22, 55	B16		4.7, 4.9
	-Q20-110, 125	20	110, 125	40	60	67, 82	27, 60	B20		4.8, 4.9
	-Q26- 65, 140, 170	26	65, 140, 170	50	65	27, 97, 127	—, 45, 110	B26N	3.6, 5.7, 5.8	
	-Q34-140, 170, 200	34	140, 170, 200	64	80	97, 127, 157	—, 117, 147	B34	5.6, 7.5, 7.9	
	-Q42-125, 190	42	125, 190	83	—	87, 152	—	B42	9.1	

- ★φC of Q26 base holder has been increased from 45mm to 50mm due to improvement of its rigidity.
- ★All base holders have a centre through-tool coolant hole.
- ★The Coupling screw & wrench are supplied as standard.
- ★When L length is required longer than standard, please specify the boring depth M.

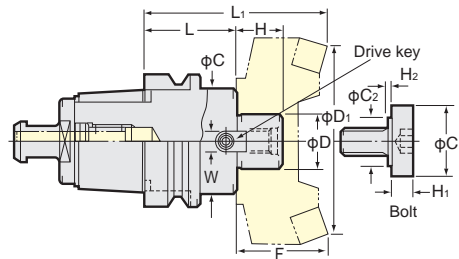


NC5 FACE MILL ARBOR (TYPE A)



For JIS B4113 Face Mill Cutter
FMH arbor is available. Please contact us.

- For the Face Milling of
φ80~φ200mm
For the NIKKEN
PRO-END MILL

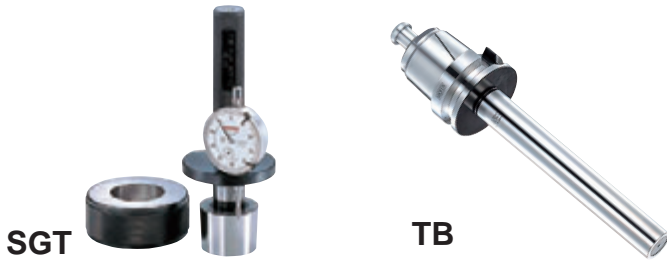


TAPER	Code No. NC5 No. -φD -L	H	C	W	C ₁	C ₂	H ₁	H ₂	Dimension of Arbor with cutter			Drive Key	Bolt	Weight (kg)
									L ₁	D ₁	F			
NC5- 46	NC5- 46-FMA25.4 -45	22	50	9.5	33	23	10	2	95	80	50	FW5	FM12	0.6
	NC5- 63-FMA25.4 -45,90	22	58	9.5	33	23	10	2	95, 140	80	50	FW5	FM12	1.6, 3.2
NC5- 63	-FMA31.75 -45,90	30	63	12.7	40	—	—	6	105, 150	100	60	FW13	FM16	1.7, 3.1
	-FMA38.1 -60	34	80	15.9	50	27	14	6	120	125	60	FW18	FM20	2.9
	NC5- 85-FMA25.4 -45,105	22	58	9.5	33	—	—	2	95, 155	80	50	FW5	FM12	2.7, 3.8
NC5- 85	-FMA31.75 -45,105	30	70	12.7	40	23	10	6	105, 165	100	60	FW12, FW13	FM16	3.0, 4.3
	-FMA38.1 -45,90	34	80	15.9	50	27	14	6	105, 150	125	60	FW18, FW19	FM20	3.4, 4.8
	-FMA47.625-70	38	128.57	25.4	—	—	—	—	130	200	60	FW26	*	6.3
	-FMA50.8 -65	36	100	19.05	65	37	14	10	125	160	60	FW23	FM24	5.0
	NC5-100-FMA25.4 -45,105	22	58	9.5	33	—	—	2	95, 155	80	50	FW5	FM12	3.7, 5.0
NC5-100	-FMA31.75 -45,105	30	70	12.7	40	23	10	6	105, 165	100	60	FW12, FW13	FM16	4.5, 6.2
	-FMA38.1 -45,95	34	80	15.9	50	27	14	6	105, 155	125	60	FW18, FW19	FM20	4.3, 5.8
	-FMA47.625-75	38	128.57	25.4	—	—	—	—	135	200	60	FW26	*	5.8
	-FMA50.8 -45	36	100	19.05	65	37	14	10	105	160	60	FW23	FM24	4.9

- ★The "D" in the Code No. shows centre bore dia. of the milling cutter.
- ★The above arbors are suitable for JIS B4113 milling cutter.
- ★The arbor marked * requires 4 fixing bolts (M16).
- ★Drive keys, wrench and bolt are supplied as standard.
- ★The above weight is for arbor and pull stud only. (not including milling cutter.)
- ★FMC22 type arbor is suitable for the NIKKEN PRO-END MILL φ50 mm.
- ★NC5-46-FMC22-40, NC5-53-FMC22-40, NC5-63-FMC22-45, NC5-85-FMC22-45, NC5-100-FMC22-60
- ★Centre through coolant type arbor for the NIKKEN PRO-END MILL is also available.
- ★Please add "C" of the Code No. e.g. NC5-63-FMA25.4C-45
- ★Centre Through Tool Coolant type arbor except NIKKEN PRO-END MILL, please provide the drawing of milling cutters.
- ★For high speed application, balancing must be required after fixing the milling cutter.

NC5

NC5 TAPER GAUGE · TEST BAR



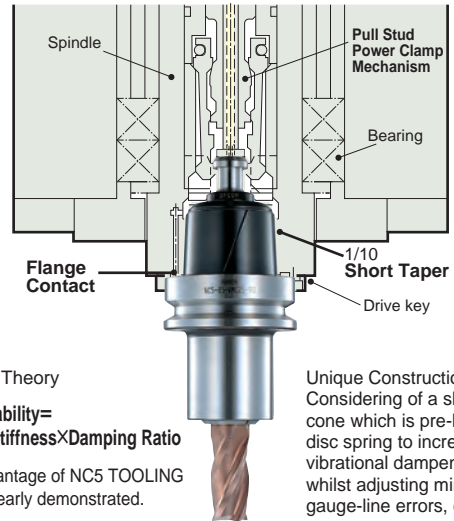
TAPER	Gauge	Test Bar (φD-L)
NC5- 46	NC5- 46-SGT	NC5- 46-TB40-200
NC5- 63	NC5- 63-SGT	NC5- 63-TB40-300
NC5- 85	NC5- 85-SGT	NC5- 85-TB40-300
NC5-100	NC5-100-SGT	NC5-100-TB40-300

★Above Code No. includes Ring GAUGE (SG-R) and Plug Gauge (SGT-P).
★Dial Gauge is not included with the Ring Gauge.

NC5 TOOLING SYSTEM is basically developed for the Machine with Centre Through Tool Coolant capability, however, of course, the system is also suitable for the Machine without Centre Through Tool Coolant capability.

NC5 TOOLING SYSTEM takes advantage of the powerful pulling force to improve its static stiffness. Therefore, please ensure that at least the following pulling force figures in the table are required for each size of **NC5 TOOLING**. The Pulling Force Measuring Tool with special Pull Stud is available for the pulling force measurement.

For manufacturing of **NC5** Machine Spindle, we could supply the Gauge for Machine Spindle as well as any other know-how about Spindle Flange Cleaning, Drive Key Mechanism and so on. Please contact with us for any technical correspondences if required.



E.H.Merritt's Theory

$$\text{Chattering Stability} = \text{Static Stiffness} \times \text{Damping Ratio}$$

Thus, the advantage of **NC5 TOOLING SYSTEM** is clearly demonstrated.

Unique Construction:
Considering of a slotted taper cone which is pre-loaded by a disc spring to increase its vibrational dampening effect whilst adjusting minute gauge-line errors, completely.



Pulling Force Measuring Tool

Even the use with 5m cable, it can be measured both manual tool change and ATC.

☞ P.263

CLP

Pull Stud Power Clamp & Lock Mechanism

Please ask for the details of **NIKKEN POWER5 SYSTEM**, Powerful Pulling & Locking Mechanism in order to gain maximum performance of the **NIKKEN NC5 TOOLING System**.

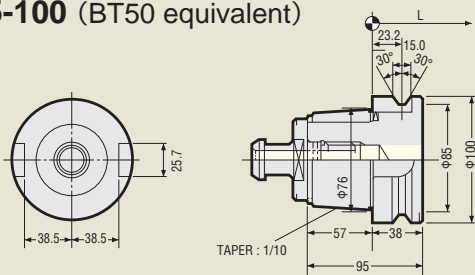
TAPER	Spindle ID	POWER 5 Code No.	Pulling Force (KN)	Measuring Tool	
				Code No.	Pull Stud
NC5- 46	30	POWER- 46-D30	4.5~ 7	NC5- 46-CLP-D30	PS-N46A
	35	-D35	5.5~ 8	-D35	-N46
NC5- 63	40	- 63-D40	11~14	- 63-CLP-D40	-N63A
	45	-D45	14~17	-D45	-N63
NC5- 85	50	- 85-D50	20~23	- 85-CLP-D50	-N85
NC5-100	55	-100-D55	24~27	-100-CLP-D55	-N100

★Pulling Force is only guideline and depends on the M/C specification. ★Pull Stud Code No. is without hole.

DIMENSION of NC5 TOOL SHANK

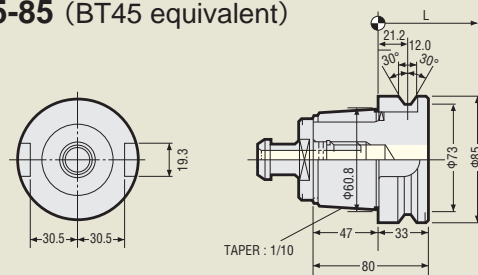


NC5-100 (BT50 equivalent)



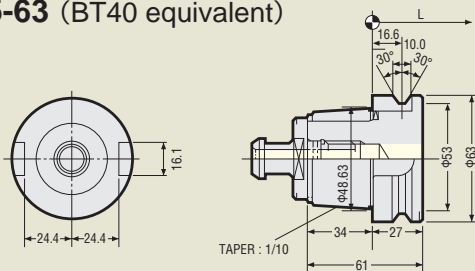
Dimensions of V Flange are same as BT50.

NC5-85 (BT45 equivalent)



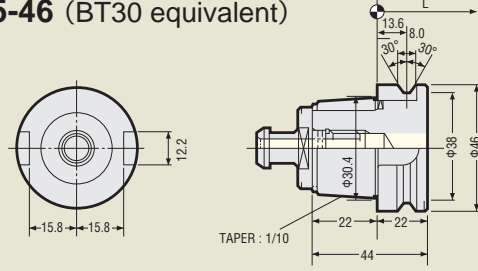
Dimensions of V Flange are same as BT45.

NC5-63 (BT40 equivalent)



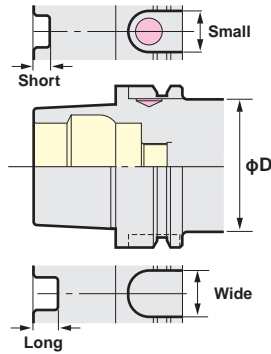
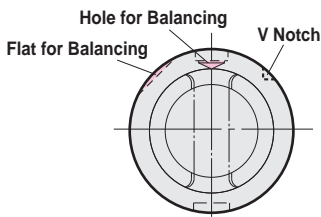
Dimensions of V Flange are same as BT40.

NC5-46 (BT30 equivalent)



Dimensions of V Flange are same as BT30.
(*Width of drive key grooves are different.)

■ HSK A...HSK40A, HSK50A, HSK63A, HSK100A



HSK A shank is based on ISO12164-1 (DIN69893-1) and Hollow Shank Taper with 1/10 Taper and Double Contact System of Taper & Flange. Its dimension is unsymmetrical shape such as;

- Depth of Drive Keys Slots are different.
- Width of U Groove are different.
- V Notch on one side.

1. It's not well balanced due to above unsymmetrical shape, therefore NIKKEN HSK A Shank has a hole and a flat for mass balancing as standard.

2. Hole for manual clamp is not standardized for the size smaller or equal to HSK50A. HSK63A and HSK100A tools without a hole for manual clamp are also available for high speed application.
3. Hole for ID is not standardized for all models.
4. HSK tool is clamped to the main spindle with clamping force more than about 2 times of BT tool by intensifying clamp mechanism.

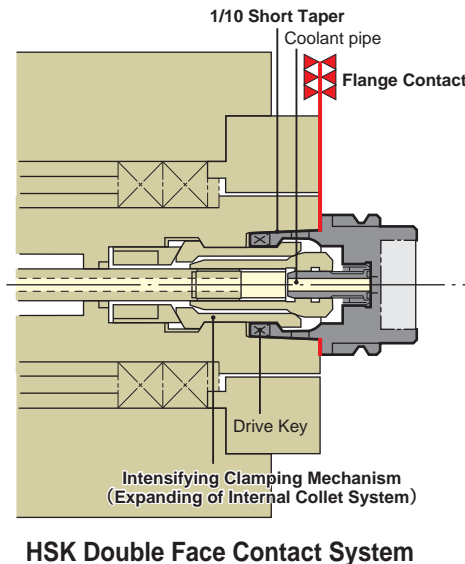
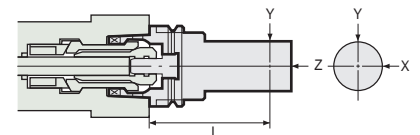
■ Clamping Force

TAPER	HSK40A	HSK50A	HSK63A	HSK100A
Clamp Force	6.8KN	11KN	18KN	45KN

5. A big clamping force and the double face contact system of 1/10 short taper & flange largely improved the static stiffness as the tool interface.
6. Higher repeatability of ATC is accomplished due to the run-out accuracy of contact flange for taper is within 0.002mm.

■ Repeatability of ATC

TAPER	L	Repeatability		
		X	Y	Z
HSK 25	40	0.002	0.002	0.002
32	50			
40	60			
50	75			
63	100			
100	150			



HSK Double Face Contact System

■ HSK E & HSK F...HSK25E, HSK32E, HSK40E, HSK50E, HSK63E, HSK63F

HSK-E type & HSK-F type holders are for High Speed Application and are manufactured to DIN69893-5 & -6 standard. The configuration of the holder is different to that of HSK-A type, the holder is designed symmetrically without drive key slots, U-groove, V-notch, holes in the taper for manual clamping and hole for I/D chip.

The tool flange diameter of HSK-E & -F are the same, but the taper size on HSK-F is one size smaller than HSK-E.

TCL-GH clamper is designed for symmetrical holders without drive key slots or U-groove.

The TCL-GH clamper is also suitable for the other shank tooling with same flange diameter as E & F type. P.222



HSK50E

HSK63F

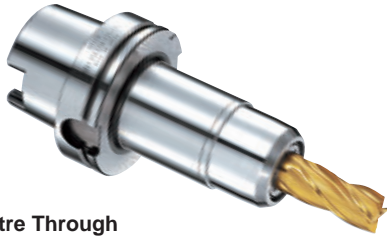
⚠ Caution

- Always ensure that swarf does not attach at the spindle flange surface, because of the double contact system. Generally the inside of the machining envelope is always covered swarf. This means that there is a possibility that the flange of the tooling may collect swarf easily at the ATC. It is therefore important that the machining envelope is regularly cleaned (Clean the ATC arm, the route through which the tooling passes, the tool pot and the spindle surfaces etc.) at least every 3 months.
- Always ensure that M/C has the mechanism to confirm the perfect flange contact.
- Always ensure that M/C has the mechanism to clean the spindle flange surface.

HSK MULTI LOCK MILLING CHUCK

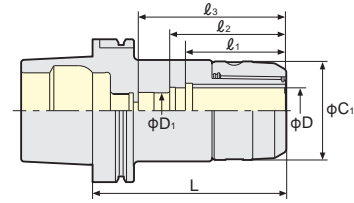


NIKKEN



C
Centre Through
MAX. 7MPa
Photo shows High Speed Milling Chuck

- ANNIVERSARY Type**
— Powerful gripping torque —
- High rigidity
 - High precision
 - Compact design



High Speed

PAT.

TAPER	Code No.	C ₁	D	D ₁	l ₁	l ₂	l ₃	MAX. min ⁻¹	Collet	Weight (kg)
HSK 40A	HSK 40A -C12- 80G	33	12	12	49	53	58	30,000	KM12 CCK12	0.5
	-C16- 80G	40	16	16	51	57	60		KM16 CCK16	0.7
	-C20-100G*2	48	20	-	-	-	57		KM20 CCK20	1.2
HSK 50A	HSK 50A -C12- 80G	33	12	12	49	53	56	30,000	KM12 CCK12	0.8
	-C16- 90G	40	16	16	51	57	60		KM16 CCK16	1.0
	-C20- 95G*2	48	20	20	58	65	68		KM20 CCK20	1.2
HSK 63A	HSK 63A -C12- 90G	33	12	12	49	53	58	30,000	KM12 CCK12	1.3
	-C16- 75G*2	40	16	-	-	-	50		25,000	KM16 CCK16
	- 90G			16	51	57	60	1.4		
	-120G			16	51	57	65	1.7		
	-C20- 85G*2	48	20	-	-	-	60	20,000	KM20 CCK20	1.5
	- 95G			20	58	65	68			1.6
	-110G			20	58	72	80			1.8
	-C25- 90G*2			20	59	62	65			1.7
	-100G	55	25	25	61	72	75	20,000	KM25 CCK25	1.9
	-130G			25	61	72	80			2.3
	-C32-110G*2			25	66	80	83			2.2
-130G	68	32	32	66	80	83	20,000	KM32 CCK32	2.6	
-130G			25	70	81	103			2.6	
HSK 100A	HSK100A -C16- 90G	40	16	16	52	56	60	20,000	KM16 CCK16	2.4
	-135G									3.0
	-C20-115G	48	20	20	58	66	80	20,000	KM20 CCK20	3.0
	-135G									3.6
	-C25-115G	55	25	25	61	72	80	15,000	KM25 CCK25	3.3
	-135G									3.6
	-C32-115G	68	32	25	66	78	83	12,000	KM32 CCK32	3.2
	-135G				70	81	103			4.0
	-165G				70	81	107			4.8
	-C42-115P				80	83	83			4.8
-165P	86	42	42	73	115	125	12,000	KM42 CCK42	7.0	

★Please note the acceptable shank tolerance is h6.
★Please refer to P.212 for KM and CCK collet.
★GH Handle is available as an option. P.30
C12G : GH12, C16G : GH16, C20G : GH20, C25G : GH25, C32G : GH32
★NK, CCNK, ONK and OJK collet can not be used for the chucks marked *2.



★GFS type P.30 is available for C25, C32 and C42.



GFS type
For machining of aluminum

HSK MULTI LOCK MILLING CHUCK

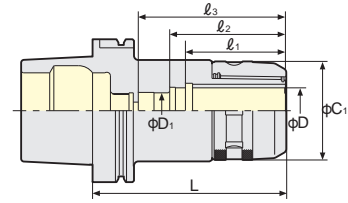


NIKKEN



C
Centre Through
MAX. 7MPa

- ANNIVERSARY Type**
— Powerful gripping torque —
- High rigidity
 - High precision
 - Compact design



PAT.

TAPER	Code No.	C ₁	D	D ₁	l ₁	l ₂	l ₃	Collet	Weight (kg)	
HSK 40A	HSK 40A-C12- 80	33	12	12	49	53	58	(KM12) (CCK12)	0.5	
	-C16- 80	44	16	16	51	57	60	(KM16) (CCK16)	0.7	
	-C20-100 ^{*2}	52	20	-	-	-	57	(KM20) (CCK20)	1.2	
HSK 50A	HSK 50A-C12- 80	33	12	12	49	53	56	(KM12) (CCK12)	0.8	
	-C16- 90	44	16	16	51	57	60	(KM16) (CCK16)	1.0	
	-C20- 95 ^{*2}	52	20	20	58	65	68	(KM20) (CCK20)	1.2	
	-C25-100	55 ^{*1}	25	25	56	72	75	(KM25) (CCK25)	1.5	
	-C32-115	64 ^{*1}	32	-	66	-	-	(KM32) (CCK32)	1.9	
HSK 63A	HSK 63A-C12- 90	33	12	12	49	53	58	(KM12) (CCK12)	1.3	
	-C16- 75 ^{*2}						50		1.2	
	- 90	44	16		16	51	57	(KM16) (CCK16)	1.4	
	-120						65		1.7	
	-C20- 85 ^{*2}						60		1.5	
	- 95	52	20		20	58	65	(KM20) (CCK20)	1.6	
	-110						72	80	1.8	
	-C25- 90 ^{*2}					59	62	65	1.7	
	-100	60	25	25			75	(KM25) (CCK25)	1.9	
	-130						80		2.3	
	-C32-110 ^{*2}	69	32		32	66	80	83	(KM32) (CCK32)	2.2
	-130				25	70	81	103		2.6
HSK 100A	HSK100A-C16- 90	44	16	16	52	56	60	(KM16) (CCK16)	2.4	
	-135								3.0	
	-C20-115	52	20	20	58	66	80	(KM20) (CCK20)	3.0	
	-135								3.6	
	-C25-115	60	25	25	61	72	80	(KM25) (CCK25)	3.3	
	-135								3.6	
	-C32-115					66	78	83		3.2
	-135							103		4.0
	-165	69	32	25		70	81	107	(KM32) (CCK32)	4.8
	-200								5.7	
	-250								7.0	
	-C42-115						80	83		4.8
-165	86	42	42	73				(KM42) (CCK42)	7.0	
-200						115	125		8.5	
-250									10.8	

★Spanner is available as an option.

C12(φC=φ30) : 9HC12 C12A(φC=φ33) : 9HC12A C16 : 9HC16
C20 : 9HC22 C25 : 9HC25 C32 : 9HC32 C42 : 9HC42

*1 C25 & φC1=55 : 9HC22, C32 & φC1=64 : 9HC25

★Please note the acceptable shank tolerance is h6~7.

★For heavy duty milling, please grip the cutter shank longer than l₁.



★NK, CCNK, ONK and OJK collet can not be used for the chucks marked *2.

★Please refer to P.212 for KM and CCK collet.

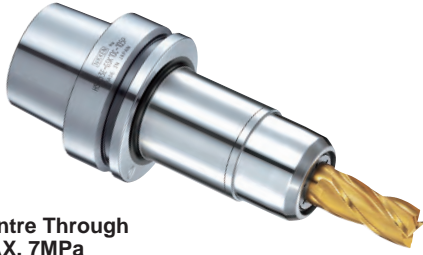
★C22 style is also available.

HSK

HSK MULTI LOCK MILLING CHUCK



NIKKEN



C

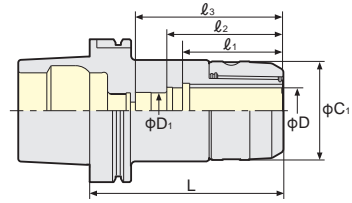
Centre Through
MAX. 7MPa

Photo shows High Speed Milling Chuck

ANNIVERSARY Type

— Powerful gripping torque —

- High rigidity
- High precision
- Compact design



TAPER	Code No.	C ₁	D	D ₁	l ₁	l ₂	l ₃	Collet	MAX.min ⁻¹	Weight (kg)
HSK 40E	HSK 40E -C12- 80G	33	12	12	49	53	58	(KM12) (CCK12)	30,000	0.5
	-C16- 80G	40	16	16	51	57	60	(KM16) (CCK16)		0.7
	-C20-100G* ²	48	20	-	-	-	57	(KM20) (CCK20)		1.2
HSK 50E	HSK 50E -C12- 80G	33	12	12	46	53	56	(KM12) (CCK12)	30,000	0.9
	-C16- 80G* ³	40	16	16	51	57	60	(KM16) (CCK16)		1.0
	-C20- 95G	48	20	20	58	65	68	(KM20) (CCK20)		1.2
HSK 63E	HSK 63E -C12- 90G	33	12	12	49	53	58	(KM12) (CCK12)	30,000	1.3
	-C16- 90G	40	16	16	51	57	60	(KM16) (CCK16)	25,000	1.4
	-C20- 95G, 110G	48	20	20	58	65, 72	68, 80	(KM20) (CCK20)		1.5, 1.8
	-C25-100G	55	25	25	61	72	75	(KM25) (CCK25)	20,000	1.9
	-C32-110G	68	32	32	66	80	83	(KM32) (CCK32)	2.2	

TAPER	Code No.	C ₁	D	D ₁	l ₁	l ₂	l ₃	Collet	MAX.min ⁻¹	Weight (kg)
HSK 63F	HSK 63F -C12- 90G	33	12	12	49	53	58	(KM12) (CCK12)	30,000	1.3
	-C16- 90G	40	16	16	51	58	65	(KM16) (CCK16)	25,000	1.4
	-C20- 95G, 110G	48	20	20	58	65, 66	68, 80	(KM20) (CCK20)		1.5
	-C25-100G	55	25	25	61	72	75	(KM25) (CCK25)	20,000	1.9
	-C32-110G	68	32	32	66	80	83	(KM32) (CCK32)		2.2

★Please note the acceptable shank tolerance is h₆.

★Please refer P.212 for KM and CCK collet.

★GH Handle is available as an option. P.30

C12G : GH12, C16G : GH16, C20G : GH20, C25G : GH25, C32G : GH32

★NK, CCNK, ONK and OJK collet can not be used for the chucks marked *2.

★Coolant pipe can not be used for the chuck marked *3.

★Please contact us for the extended L length.



★GFS type P.30 is available for C25 and C32.



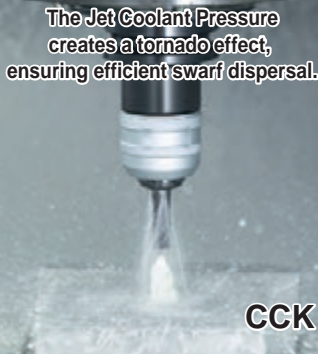
GFS type
For machining
of aluminum

CENTRE COOLANT STRAIGHT COLLET

NIKKEN

PAT.

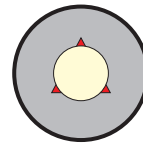
Suitable for all models of the NIKKEN MILLING CHUCK



CCK Collet

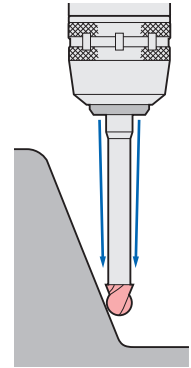


Front Nut

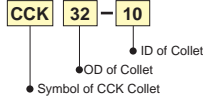


Jet Coolant

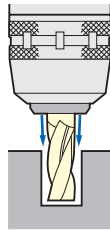
Prevention of Swarf entering the collet through the slots



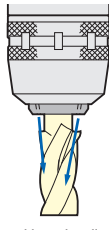
Explanation of the Code No.



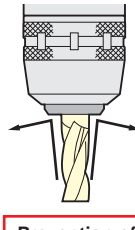
CCK : Centre Coolant
CCNK : Centre Coolant, Adjustable
KM : Standard
NK : Adjustable
ONK : Oil Hole Drill
OJK-A : Jet Coolant
OJK-S : Multiple Nozzles



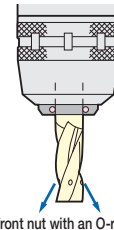
For grooving.



For cutters with cutting diameter which is larger than the shank diameter.



Prevention of the swarf contamination.



A front nut with an O-ring seal, for use with oil hole cutter, is also available as option.



CKFN-MN



CKFN-C

CCK Collet

CKFN front nut and CCKL spanner are available as an option.



Photo shows with front nut.

CCK

Style	CCK Collet Code No. (OD-ID)	Front Nut Code No.
CCK12	CCK12-3, 4, 5, 6, 8, 10	CKFN12
CCK16	CCK16-3, 4, 5, 6, 8, 10, 12	CKFN16
CCK20	CCK20-6, 8, 10, 12, 16	CKFN20
CCK25	CCK25-6, 8, 10, 12, 16, 20	CKFN25
CCK32	CCK32-6, 8, 10, 12, 16, 20, 25	CKFN32, CKFN32T
CCK42	CCK42-6, 8, 10, 12, 16, 20, 25, 32	CKFN42

★Above bold figures indicate "ANNIVERSARY" type CCK Collet.
★Please note the acceptable shank tolerance is h_6-h_7 .
★Other metric sizes and imperial sizes, 1/8, 1/4, 5/16, 3/8, 7/16, 1/2, 5/8, 3/4, 13/16, 7/8, 1, 1-1/8, 1-1/4, 1-1/2" are also available.



Photo shows with front nut.

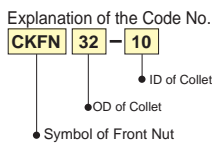
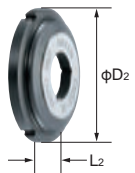
CCNK

Style	CCNK Collet Code No. (OD-ID)	Front Nut Code No.
CCNK20	CCNK20-6, 8, 10, 12, 16	CKFN20
CCNK25	CCNK25-6, 8, 10, 12, 16, 20	CKFN25
CCNK32	CCNK32-6, 8, 10, 12, 16, 20, 25	CKFN32, CKFN32T
CCNK42	CCNK42-6, 8, 10, 12, 16, 20, 25, 32	CKFN42

★Please note the acceptable shank tolerance is h_6-h_7 .
★Other metric sizes and imperial sizes, 1/8, 1/4, 5/16, 3/8, 7/16, 1/2, 5/8, 3/4, 13/16, 7/8, 1, 1-1/8, 1-1/4, 1-1/2" are also available.

Front Nut

CKFN



Style	φD ₂	L ₂	Front Nut Code No.
CKFN12	19.5	7	CKFN12 -3, 4, 5, 6, 8, 10
CKFN16	28.5	8	CKFN16 -3, 4, 5, 6, 8, 10, 12
CKFN20	33	8	CKFN20 -6, 8, 10, 12, 16
CKFN25	39	8.5	CKFN25 -6, 8, 10, 12, 16, 20
CKFN32	46.5	9	CKFN32 -6, 8, 10, 12, 16, 20, 25
CKFN32T	43	9	CKFN32T -6, 8, 10, 12, 16, 20, 25
CKFN42	59.5	9	CKFN42 -6, 8, 10, 12, 16, 20, 25, 32



★The front nut for direct chucking is also available.
e.g. CKFN20-20D, CKFN25-25D, CKFN32-32D

★The Code No. fitted with O-ring is:
e.g. CKFN20-20DC, CKFN25-25DC, CKFN32-32DC

★For C32 there are 2 sizes, CKFN32 = for nose ring diameter of φ69mm, CKFN32T = for nose ring diameter of φ64mm.
★Jet Coolant type for the cutter with a cutter dia. larger than shank dia. is also available.
CKFN25-20MN, CKFN32-25MN, CKFN42-32M
★Front Nut fitted with an O-ring is also available.
e.g. The Code No. is CKFN32-10C
★The spanner is available as an option.
CKFN12:CCKL12, CKFN16:CCKL16
CKFN20:CCKL20
CKFN25, CKFN32T:CCKL25
CKFN32:CCKL32, CKFN42:CCKL42



KM Photo shows ANNIVERSARY type KM Collet.

Style	KM Collet Code No. (OD-ID)
KM12	KM12-2, 3, 4, 5, 6, 7, 8, 9, 10
KM16	KM16-2, 3, 4, 5, 6, 7, 8, 9, 10, 11, 12
KM20	KM20-2, 3, 4, 5, 6, 7, 8, 9, 10, 11, 12, 13, 14, 15, 16
KM25	KM25-3, 4, 5, 6, 7, 8, 9, 10, 11, 12, 13, 14, 15, 16, 17, 18, 19, 20, 21, 22
KM32	KM32-3, 4, 5, 6, 7, 8, 9, 10, 11, 12, 13, 14, 15, 16, 17, 18, 19, 20, 21, 22, 23, 24, 25, 26, 30
KM42	KM42-3, 4, 5, 6, 7, 8, 9, 10, 11, 12, 13, 14, 15, 16, 17, 18, 19, 20, 21, 22, 23, 24, 25, 26, 27, 28, 29, 30, 31, 32, 40

★[For Synchronous Tapping Program] : Special ID Collets for Tap Shank are also available.
★Other metric sizes and imperial sizes, 1/8, 1/4, 5/16, 3/8, 7/16, 1/2, 5/8, 3/4, 13/16, 7/8, 1, 1-1/8, 1-1/4, 1-1/2" are also available.
★The collets with bold character are the "ANNIVERSARY" type KM Collet.
Ordinary KM Collet can be used with "ANNIVERSARY" type Milling Chuck, but better performance can be found with the "ANNIVERSARY" type KM Collet.
★Please note the acceptable shank tolerance is h_6-h_7 .

Cutter length adjustment on the collet is possible from front and back.



NK

Style	NK Collet Code No. (OD-ID)
NK20	NK20-3, 4, 5, 6, 7, 8, 9, 10, 11, 12, 13, 14, 15, 16
NK22	NK22-3, 4, 5, 6, 7, 8, 9, 10, 11, 12, 13, 14, 15, 16, 17, 18
NK25	NK25-3, 4, 5, 6, 7, 8, 9, 10, 11, 12, 13, 14, 15, 16, 17, 18, 19, 20, 21, 22
NK32	NK32-3, 4, 5, 6, 7, 8, 9, 10, 11, 12, 13, 14, 15, 16, 17, 18, 19, 20, 21, 22, 23, 24, 25, 26
NK42	NK42-3, 4, 5, 6, 7, 8, 9, 10, 11, 12, 13, 14, 15, 16, 17, 18, 19, 20, 21, 22, 23, 24, 25, 26, 27, 28, 29, 30, 31, 32

★[For Synchronous Tapping Program] : Special ID Collets for Tap Shank are also available.
★Other metric sizes and imperial sizes, 1/8, 1/4, 5/16, 3/8, 7/16, 1/2, 5/8, 3/4, 13/16, 7/8, 1, 1-1/8, 1-1/4, 1-1/2" are also available.
★The collets with bold character are standard.
★Please note the acceptable shank tolerance is h_6-h_7 .
★Collet removal (9CKR) is available as an option.
★Please refer P.31, P.32 for more detail of the straight collet.



HSK

HSK HIGH SPEED SLIM CHUCK



SK
Centre Through
MAX. 7MPa

Photo shows High Speed HSK Slim Chuck

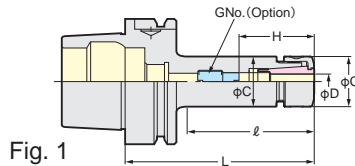


Fig. 1

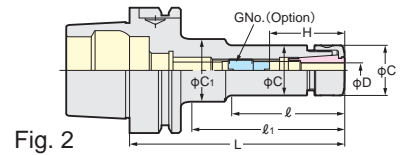


Fig. 2

H1: MAX. H without adjust screw

High Speed

Please add "-J" at the end of code No. for the chuck with SK J type nut. (Cap is not included, please order separately) e.g. HSK63A-SK10C-105P-J
When SK J type nut is used, the total chuck length will be extended by 6mm. **PAT.**

TAPER	Code No.	φD	H	H1	ℓ1	ℓ2	C	C1	G No. (Option)	MAX. min ⁻¹	Weight (kg)	Fig.	SK Collet
HSK 40A	HSK 40A-SK 6 - 60P*3	0.7~6.0	40	40	37	-	19.5	-	-	40,000	0.28	1	SK 6
	-SK10 - 75P*2	1.75~10.0	29~36	43	52	-	27.5	-	SKG-6L		0.4		SK10
	-SK13 - 75P*3	2.75~13.0	55	55	54	-	33	-	-		0.5		SK13
	-SK16 - 80P*3	2.75~16.0	60	60	59	-	40	-	-		0.6		SK16
HSK 50A	HSK 50A-SK 6 - 60P*3	0.7~6.0	37	37	31	-	19.5	-	-	30,000	0.4	1	SK 6
	-SK 6C- 80P		26~31	46	51	-	27.5	-	SKG6-6HG		0.5		SK10
	-SK10 - 60P*3	35	35	33	-	-	-	-	0.5		SK10		
	-SK10 - 90P*3	35~41	65	63	-	33	-	SKG-12S	0.6		SK13		
	-SK13 - 70P*3	2.75~13.0	47	47	43	-	-	-	-	0.9	SK13		
	-SK13 -105P*2		31~47	80	76	-	40	-	SKG-15	1.2	SK16		
	-SK16 - 80P*3	2.75~16.0	52	52	53	-	-	-	-	0.6	SK16		
	-SK16 -105P*2		50~58	65	78	-	-	-	SKG-6L-25L	0.9	SK16		
HSK 63A	HSK 63A-SK 6 - 60P*3	0.7~6.0	38	38	31	-	19.5	-	-	30,000	0.7	1	SK 6
	-SK 6C-100P		26~31	46	62	71		32	SKG6-6HG		0.9		
	-SK 6C-120P	26~31	46	62	91	32	SKG6-6HG	1.0	2				
	-SK10 - 60P*3	35	35	31	-	-	-	0.7	1		SK10		
	-SK10C-105P	1.75~10.0	33~41	58	74	-	27.5	-		SKG10-10HG		1.1	
	-SK10C-120P		33~41	58	60	91	32	SKG10-10HG	1.3	2			
	-SK13 - 70P*3	2.75~13.0	45	45	43	-	-	-	0.9	1	SK13		
	-SK13 -105P*2		31~47	80	74	-	33	-	SKG-15			1.2	
	-SK13C-120P	39~51	68	89	-	-	-	1.5	SKG13-10HG				
	-SK16 - 80P*3	52	52	51	-	-	-	1.1	-				
	-SK16 -105P*2	2.75~16.0	50~58	65	76	-	40	-	1.3	1	SK16		
	-SK16C-120P		45~52	77	91	-	-	-	1.6				
	-SK20 - 90P*3	3.5~20.0	59	59	63	-	-	-	1.4	1	SK20		
	-SK20 -105P*2		50~57	64	78	-	48.5	-	1.6				
	-SK20C-120P		50~55	74	93	-	-	-	1.8				
	-SK20C-135P		50~55	74	108	-	-	-	2.0				
	-SK25 - 90P*3	7.5~25.4	63	63	61	-	55	-	1.6	1	SK25		
	-SK25C-135P		60~65	91	108	-	-	-	1.9				
HSK 100A	HSK100A-SK 6C-105P	0.7~6.0	26~31	46	62	71	19.5	-	SKG6-6HG	20,000	1.2	2	SK 6
	-SK10C-105P		26~31	46	57	-	40	-	-		2.6		
	-SK10C-120P	1.75~10.0	33~41	58	74	86	27.5	-	SKG10-10HG		2.9	1	SK10
	-SK10C-150P		33~41	58	80	116	-	-	3.2				
	-SK13 -105P*3	2.75~13.0	63	63	71	-	-	-	2.7	1	SK13		
	-SK13C-120P		39~51	68	86	-	33	-	3.1				
	-SK13C-150P	39~51	68	116	-	45	-	3.4					
	-SK16 -105P*2	2.75~16.0	45~60	63	71	-	-	-	2.7			2	SK16
	-SK16C-120P		45~52	77	86	-	40	-	3.2				
	-SK16C-150P	45~52	77	84	90	116	50	-	3.5	2			
	-SK20C-120P	3.5~20.0	50~55	74	86	-	-	-	3.1	1	SK20		
	-SK20C-150P		47~63	82	116	-	48.5	-	3.5				
	-SK20C-200P		47~63	82	166	-	-	-	4.2				
	-SK25 -120P*2	7.5~25.4	55~75	76	86	-	55	-	3.4	1	SK25		
	-SK25C-145P		60~65	91	111	-	-	-	4.8				

★Nut, adjust screw and collet extractor are supplied as standard. ★Please refer P.216 for SK collet and please refer P.43 for J type nut.
 ★Collet, adjust screw (G No.) and GH Handle are available as an option. The Code No. of the GH Handle is SK6C-P:GH6, SK10C-P:GH10, SK13C-P:GH13, SK16C-P:GH16, SK20C-P:GH20, SK25C-P:GH25
 ★All Slim Chucks are High Pressure centre Through Coolant type (MAX. 7MPa). SK6C:φ4~φ6, SK10C:φ6~φ10, SK16C:φ10~φ16, SK25C:φ16~φ25
 ★Slim Chucks marked *2 and *3 can be used for the centre through coolant type with J type nut. ★No adjust screw is applied for the Slim Chucks marked *3. P.30
 ★The "H1" is the MAX. dimension without the adjust screw. ★ is C type.



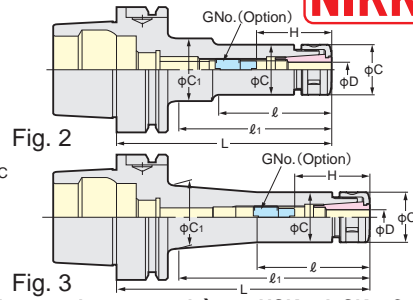
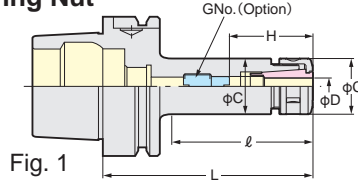
HSK SLIM CHUCK



High Precision·High Speed
Power of TiN Bearing Nut



SK
Centre Through
MAX. 7MPa



Please add "-J" at the end of code No. for the chuck with SK J type nut. (Cap is not included, please order separately) e.g. HSK63A-SK10C-105-J
When SK J type nut is used, the total chuck length will be extended by 6mm. **PAT.**

TAPER	Code No.	φD	H	H ₁	l ₁	l ₂	C	C ₁	G No. (Option)	Weight (kg)	Fig.	SK Collet	
HSK 40A	HSK 40A -SK 6 - 60* ³	0.7~6.0	40	40	37	-	19.5	-	-	0.28	1	SK 6	
	-SK 6C- 80		26~31	46	57	-			SKG6-6HG	0.32			
	-SK10 - 60* ³	1.75~10.0	40	40	39	-	27.5	-	-	0.35	1	SK10	
	-SK10C-100		29~36	43	52	-			SKG-6L	0.4			
	-SK13 - 75	2.75~13.0	33~41	58	77	-	33	-	-	0.5	1	SK13	
	-SK13C-120		55	55	54	-			SKG10-10HG	0.5			
	-SK16 - 80* ²	2.75~16.0	39~51	68	100	-	40	-	-	0.8	1	SK16	
	-SK16C-120		60	60	59	-			SKG13-10HG	0.6			
-SK16 - 120	2.75~16.0	45~52	77	99	-	40	-	-	0.9	1	SK16		
-SK16C-120		60	60	59	-			SKG16-10HG	0.6				
HSK 50A	HSK 50A -SK 6 - 60* ³	0.7~6.0	37	37	31	-	19.5	-	-	0.4	1	SK 6	
	-SK 6C- 80		26~31	46	51	-			SKG6-6HG	0.5			
	-SK10 - 60* ³	1.75~10.0	35	35	33	-	27.5	-	-	0.5	1	SK10	
	-SK10C- 90* ²		35~41	65	63	-			SKG-12S	0.6			
	-SK10C-105	2.75~13.0	35~41	58	76	-	33	-	-	0.7	1	SK13	
	-SK13 - 70		47	47	43	-			SKG10-10HG	0.9			
	-SK13 - 105	2.75~13.0	31~47	80	76	-	33	-	-	1.2	1	SK13	
	-SK13C-120		39~51	68	89	-			SKG-15	1.2			
	-SK16 - 80* ³	2.75~16.0	52	52	53	-	40	-	-	1.4	1	SK16	
	-SK16C-120		50~58	65	78	-			SKG13-10HG	1.4			
	-SK16 - 105* ²	2.75~16.0	45~52	77	93	-	40	-	-	0.6	1	SK16	
	-SK16C-120		50~58	65	78	-			SKG-6L-25L	0.9			
-SK16C-120	2.75~16.0	45~52	77	93	-	40	-	-	1.1	1	SK16		
-SK16C-120		45~52	77	93	-			SKG16-10HG	1.1				
HSK 63A	HSK 63A -SK 6 - 60	0.7~6.0	38	38	31	-	19.5	-	-	0.7	1	SK 6	
	-SK 6C-100		26~31	46	62	71			32	-			0.9
	-SK 6C-120		26~31	46	62	91			32	SKG6-6HG			1.0
	-SK 6C-150		26~31	46	60	121			25	-			1.2
	-SK10 - 60* ³	1.75~10.0	35	35	31	-	27.5	-	-	0.7	1	SK10	
	-SK10C-105		33~41	58	74	-			-	1.1			
	-SK10C-120		33~41	58	60	91			32	SKG10-10HG			1.3
	-SK10C-135		33~41	58	75	106			40	-			1.5
	-SK10C-150	1.75~10.0	33~41	58	73	121	34.5	-	1.7	2	SK10		
	-SK13 - 70		45	45	43	-	-	0.9					
	-SK13 - 105		31~47	80	74	-	33	SKG-15	1.2				
	-SK13C-120		39~51	68	89	-	39	SKG13-10HG	1.5				
	-SK13C-150	2.75~13.0	39~51	68	88	119	39	-	1.8	3	SK13		
	-SK16 - 80* ³		52	52	51	-	-	1.1					
	-SK16 - 105* ²		50~58	65	76	-	-	1.3					
	-SK16C-120		45~52	77	91	-	40	SKG-8	1.3				
	-SK16C-150	2.75~16.0	45~57	84	121	-	40	SKG16-10HG	1.6	1	SK16		
	-SK20 - 90		59	59	63	-	-	1.4					
	-SK20 - 105		50~57	64	78	-	-	1.6					
	-SK20C-120		50~55	74	93	-	48.5	SKG16-12HG	1.7				
	-SK20C-135	3.5~20.0	50~55	74	108	-	48.5	-	2.0	1	SK20		
	-SK25 - 90* ³		63	63	61	-	-	1.4					
	-SK25C-135		60~65	91	108	-	-	1.8					
	-SK25C-135		60~65	91	108	-	-	2.0					
HSK 100A	HSK100A -SK 6C-105	0.7~6.0	26~31	46	62	71	19.5	40	-	1.6	2	SK 6	
	-SK10C-105		26~31	46	62	71			40	SKG25-18HGE			1.9
	-SK10C-120	1.75~10.0	33~41	58	57	71	27.5	40	-	1.2	1	SK10	
	-SK10C-150				74	86			-	2.6			
	-SK10C-200* ¹				80	116			-	2.9			
	-SK13 - 105				75	166			-	3.2			
	-SK13 - 105	2.75~13.0	63	63	71	-	33	-	-	2.7	2	SK13	
	-SK13C-120				86	-			-	3.1			
	-SK13C-150				116	-			45	SKG13-10HG			3.4
	-SK13C-200				92	166			45	-			3.8
	-SK16 - 105* ²	2.75~16.0	45~60	63	71	-	40	-	-	2.7	1	SK16	
	-SK16C-120				86	-			-	2.7			
	-SK16C-150				84	90			116	-			3.2
	-SK16C-200* ¹				84	90			166	-			3.5
	-SK20C-120	3.5~20.0	50~55	74	86	-	48.5	-	-	3.1	2	SK20	
	-SK20C-150				86	-			-	3.1			
	-SK20C-200				116	-			50	SKG20-12MFHG			3.1
	-SK25 - 120				47~63	82			166	-			48.5
	-SK25C-145	16.0~25.4	55~75	76	86	-	55	-	-	3.4	2	SK25	
	-SK25C-145				60~65	91			111	-			4.8

*Collet, adjust screw (G No.) and spanner are available as an option. ★Please refer P.216 for SK collet and please refer P.43 for J type nut.
The Code No. of the spanner is SK6C (C=φ19.5): SKL-6, SK6C (C=φ19.5): SKL-6W, SK10C: SKL-10, SK13C: 9HC12A, SK16C: 9HC12A, SK20C: 9HC22, SK25C: 9HC25
★H₁ means MAX.H without an adjust screw. ★No adjust screw is applied for the Slim Chucks marked *3.
★All Slim Chucks are High Pressure centre Through Coolant type (MAX. 7MPa). SK6C: φ4~φ6, SK10C: φ6~φ10, SK16C: φ10~φ16, SK25C: φ16~φ25
★Slim Chucks marked *2 and *3 can be used for the centre through coolant type with J type nut. ★ is C type. HSK40A-SK16C-120, HSK50A-SK6C-80, HSK63A-SK25C-135

HSK-E, F SLIM CHUCK



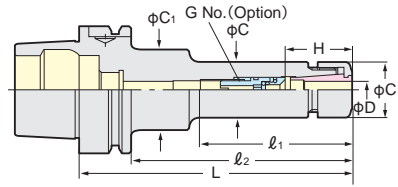
HSK63E



HSK63F

SK-P
Centre Through
MAX. 7MPa

High Speed



Please add "-J" at the end of code No. for the chuck with SK J type nut. (Cap is not included, please order separately) e.g. HSK63E-SK10C-105P-J
When SK J type nut is used, the total chuck length will be extended by 6mm. **PAT.**

TAPER	Code No.	φD	H	H ₁	l ₁	l ₂	C	C ₁	G No. (Option)	SK Collet	MAX. min ⁻¹	Weight (kg)	
HSK 25E	HSK 25E-SK 6 - 45P ^{*3}	0.7~6.0	30.5	30.5	35		19.5			SK 6	50,000	0.1	
	-SK10 - 55P ^{*3}	1.75~10.0	41	41	45		27.5			SK10		0.18	
HSK 32E	HSK 32E-SK 6 - 50P ^{*3}	0.7~6.0	32	32	29		19.5			SK 6	50,000	0.17	
	-SK10 - 60P ^{*3} , 75P ^{*2}	1.75~10.0	44, 29~36	44, 43	41, 54		27.5			-, SKG-6L		SK10	0.26, 0.30
HSK 40E	HSK 40E-SK 6 - 60P ^{*3}	0.7~6.0	40	40	37		19.5			SK 6	40,000	0.28	
	-SK10 - 60P ^{*3} , 75P ^{*2}	1.75~10.0	40, 29~36	40, 43	39, 54		27.5			-, SKG-6L		SK10	0.4, 0.5
	-SK13 - 75P ^{*3}	2.75~13.0	55	55	54		33					SK13	0.6
	-SK16 - 80P ^{*3}	2.75~16.0	59	59	59		40					SK16	
HSK 50E	HSK 50E-SK 6 - 60P ^{*3}	0.7~6.0	40	40	33		19.5			SK 6	30,000	0.5	
	-SK 6C- 80P		26~31	46	51					SKG6-6HG		0.6	
	-SK10 - 60P ^{*3}	35	35	33			0.5						
	-SK10C-105P	1.75~10.0	33~41	58	76		27.5			SKG10-10HG		SK10	0.7
	-SK13 - 70P ^{*3} , 105P ^{*2}	2.75~13.0	47, 31~47	47, 80	43, 76		33			-, SKG15		SK13	1.0, 1.3
	-SK16 - 80P ^{*3}	2.75~16.0	52	52	53		40					SK16	0.6
-SK16C-120P	45~52	77	93	SKG16-10HG	25,000	1.1							
HSK 63E	HSK 63E-SK 6C-100P, 120P	0.7~6.0	26~31	46	62, 62	71, 91	19.5	32, 32	SKG6-6HG	SK 6	30,000	0.9, 1.0	
	-SK10C-105P, 120P, 150P	1.75~10.0	33~41	58	60, 75, 73	106, 121	27.5	32, 40, 34.5	SKG10-10HG	SK10		1.3, 1.5, 1.7	
	-SK13 - 70P ^{*3} , 105P ^{*2}	2.75~13.0	45, 31~47	45, 80	43, 74		33		-, SKG15	SK13	1.0, 1.3		
	-SK13C-120P	39~51	68	89	SKG13-10HG		1.6						
	-SK16C-120P, 150P	2.75~16.0	45~52	77	91, 121		40		SKG16-10HG	SK16	1.7, 1.8		
	-SK20C-120P, 135P	3.5~20.0	50~55	74	93, 108		48.5		SKG20-12MFHG	SK20	1.8, 2.0		
-SK25C-135P	7.5~25.4	60~65	91	108	55		SKG25-18HGE	SK25	20,000	1.9			

TAPER	Code No.	φD	H	H ₁	l ₁	l ₂	C	C ₁	G No. (Option)	SK Collet	MAX. min ⁻¹	Weight (kg)			
HSK 63F	HSK 63F-SK10 - 90P ^{*3}	1.75~10.0	35~45	-	59		27.5			SK10	30,000	0.6			
	-SK10C-105P		33~41	58	74					SKG10-10HG		1.3			
	-SK13 - 70P ^{*3}	45	45	43			1.0								
	-SK13 -105P ^{*2}	2.75~13.0	31~47	80	74		33		SKG-15	SK13		1.3			
	-SK13C-120P	39~51	68	89	SKG13-10HG		1.6								
	-SK16 - 90P ^{*3}	2.75~16.0	67	67	61				40				SK16	30,000	1.2
	-SK16 -105P ^{*2}		50~58	83	76								SKG-18S		1.7
	-SK16C-120P	45~52	77	91	SKG16-10HG		1.8								
	-SK20C-120P	3.5~20.0	50~55	74	93		48.5		SKG20-12MFHG	SK20		25,000	1.8		
	-SK25 - 90P ^{*3}	7.5~25.4	67	67	61		55			SK25		20,000	1.6		

★Nut, adjust screw and collet extractor are supplied as standard.

★Please refer P.216 for SK collet and please refer P.43 for J type nut.

★Collet, adjust screw (G No.) and GH Handle are available as an option.

The Code No. of the GH Handle is SK6C-P: GH6, SK10C-P: GH10, SK13C-P: GH13, SK16C-P: GH16, SK20C-P: GH20, SK25C-P: GH25

★All Slim Chucks are High Pressure centre Through Coolant type (MAX. 7MPa). SK6C:φ4~φ6, SK10C:φ6~φ10, SK16C:φ10~φ16, SK25C:φ16~φ25

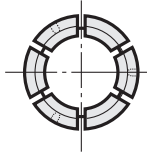
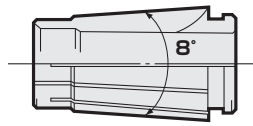
★Slim Chucks marked *2 and *3 can be used for the centre through coolant type with J type nut.

★No adjust screw is applied for the Slim Chucks marked *3.

★H1 means MAX.H without an adjust screw. ★ is C type. HSK63F-SK10C-105P



SLIM CHUCK COLLET



Explanation of the Code No.

SK 10 - 6 P

- Non: Standard
- P: P class (Run-out Accuracy=3μm)
- A: A type (for End Mill Shank)
- MAX. Chucking Dia.
- Style No.
- Symbol of SK Collet

SK "A" type SK collet (for End Mill Shank) are marked **P**. The acceptable shank tolerance is h8. Code No. is e.g. SK10-10A
 "P" class SK collet (for drill) are available for all series. e.g. SK10-10P

Code No.	Chucking D
SK 6- 0.8	0.7 ~ 0.8
- 1	0.9 ~ 1.0
- 1.25	1.15~ 1.25
- 1.5	1.3 ~ 1.5
- 1.75	1.55~ 1.75
- 2	1.8 ~ 2.0
- 2.25	2.05~ 2.25
- 2.5	2.3 ~ 2.5
- 2.75	2.55~ 2.75
- 3	2.8 ~ 3.0
- 3.5	3.0 ~ 3.5
- 4	3.5 ~ 4.0
- 4.5	4.0 ~ 4.5
- 5	4.5 ~ 5.0
- 5.5	5.0 ~ 5.5
- 6	5.5 ~ 6.0
SK10- 2	1.75~ 2.0
- 2.25	2.0 ~ 2.25
- 2.5	2.25~ 2.5
- 2.75	2.5 ~ 2.75
- 3	2.75~ 3.0
- 3.5	3.0 ~ 3.5
- 4	3.5 ~ 4.0
- 4.5	4.0 ~ 4.5
- 5	4.5 ~ 5.0
- 5.5	5.0 ~ 5.5
- 6	5.5 ~ 6.0
- 6.5	6.0 ~ 6.5
- 7	6.5 ~ 7.0
- 7.5	7.0 ~ 7.5
- 8	7.5 ~ 8.0
- 8.5	8.0 ~ 8.5
- 9	8.5 ~ 9.0
- 9.5	9.0 ~ 9.5
- 10	9.5 ~ 10.0

Code No.	Chucking D
SK13- 3	2.75~ 3.0
- 3.5	3.0 ~ 3.5
- 4	3.5 ~ 4.0
- 4.5	4.0 ~ 4.5
- 5	4.5 ~ 5.0
- 5.5	5.0 ~ 5.5
- 6	5.5 ~ 6.0
- 6.5	6.0 ~ 6.5
- 7	6.5 ~ 7.0
- 7.5	7.0 ~ 7.5
- 8	7.5 ~ 8.0
- 8.5	8.0 ~ 8.5
- 9	8.5 ~ 9.0
- 9.5	9.0 ~ 9.5
- 10	9.5 ~ 10.0
- 10.5	10.0~ 10.5
- 11	10.5~ 11.0
- 11.5	11.0~ 11.5
- 12	11.5~ 12.0
- 12.5	12.0~ 12.5
- 13	12.5~ 13.0

Code No.	Chucking D
SK16- 3	2.75~ 3.0
- 3.5	3.0 ~ 3.5
- 4	3.5 ~ 4.0
- 4.5	4.0 ~ 4.5
- 5	4.5 ~ 5.0
- 5.5	5.0 ~ 5.5
- 6	5.5 ~ 6.0
- 6.5	6.0 ~ 6.5
- 7	6.5 ~ 7.0
- 7.5	7.0 ~ 7.5
- 8	7.5 ~ 8.0
- 8.5	8.0 ~ 8.5
- 9	8.5 ~ 9.0
- 9.5	9.0 ~ 9.5
- 10	9.5 ~ 10.0
- 10.5	10.0~ 10.5
- 11	10.5~ 11.0
- 11.5	11.0~ 11.5
- 12	11.5~ 12.0
- 12.5	12.0~ 12.5
- 13	12.5~ 13.0
- 13.5	13.0~ 13.5
- 14	13.5~ 14.0
- 14.5	14.0~ 14.5
- 15	14.5~ 15.0
- 15.5	15.0~ 15.5
- 16	15.5~ 16.0

Code No.	Chucking D
SK20- 4	3.5 ~ 4.0
- 4.5	4.0 ~ 4.5
- 5	4.5 ~ 5.0
- 5.5	5.0 ~ 5.5
- 6	5.5 ~ 6.0
- 6.5	6.0 ~ 6.5
- 7	6.5 ~ 7.0
- 7.5	7.0 ~ 7.5
- 8	7.5 ~ 8.0
- 8.5	8.0 ~ 8.5
- 9	8.5 ~ 9.0
- 9.5	9.0 ~ 9.5
- 10	9.5 ~ 10.0
- 10.5	10.0~ 10.5
- 11	10.5~ 11.0
- 11.5	11.0~ 11.5
- 12	11.5~ 12.0
- 12.5	12.0~ 12.5
- 13	12.5~ 13.0
- 13.5	13.0~ 13.5
- 14	13.5~ 14.0
- 14.5	14.0~ 14.5
- 15	14.5~ 15.0
- 15.5	15.0~ 15.5
- 16	15.5~ 16.0
- 16.5	16.0~ 16.5
- 17	16.5~ 17.0
- 17.5	17.0~ 17.5
- 18	17.5~ 18.0
- 18.5	18.0~ 18.5
- 19	18.5~ 19.0
- 19.5	19.0~ 19.5
- 20	19.5~ 20.0

Code No.	Chucking D
SK25- 8	7.5~ 8.0
- 10	9.5~ 10.0
- 12	11.5~ 12.0
- 16	15.5~ 16.0
- 16.5	16.0~ 16.5
- 17	16.5~ 17.0
- 17.5	17.0~ 17.5
- 18	17.5~ 18.0
- 18.5	18.0~ 18.5
- 19	18.5~ 19.0
- 19.5	19.0~ 19.5
- 20	19.5~ 20.0
- 20.5	20.0~ 20.5
- 21	20.5~ 21.0
- 21.5	21.0~ 21.5
- 22	21.5~ 22.0
- 22.5	22.0~ 22.5
- 23	22.5~ 23.0
- 23.5	23.0~ 23.5
- 24	23.5~ 24.0
- 24.5	24.0~ 24.5
- 25	24.5~ 25.0
- 25.4	25.0~ 25.4

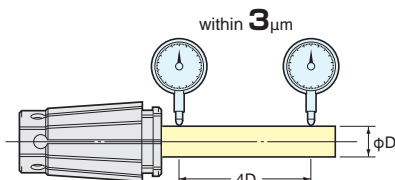
★SK6 collet with the special internal dia. is also available.



Collet removal (SKR-6) is supplied as standard only for SK6. SKR-10, SKR-16 and SKR-25 are available as an option. Collet removal is not necessary for the new types of collet (SK10 to SK25 collet including SK13 and SK20).

"P" class SK collet for drill

It guarantees the Run-out accuracy within 3 micron at the nose (4D) from the chuck. Additionally Collet Set is also available.



"A" type SK collet for endmill

The acceptable shank tolerance is h8.

SK Collet A type
SK 6-3A, 3.175A, 4A, 5A, 6A
SK10-3A, 3.175A, 4A, 5A, 6A, 8A, 10A
SK13-3A, 4A, 5A, 6A, 8A, 10A, 12A
SK16-3A, 4A, 5A, 6A, 8A, 10A, 12A, 16A
SK20-4A, 5A, 6A, 8A, 10A, 12A, 16A, 20A
SK25-8A, 10A, 12A, 16A, 20A, 25A

HSK

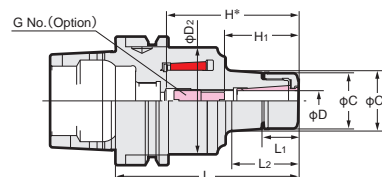


Dampening Effect TiN Bearing Effect

NEW

MDSK6
MDSK13 Series Addition

H* : MAX. Cutter Shank Length to be inserted



MDSK

PAT.

TAPER	Code No.	D	L	L1	L2	C	C1	C2	H*	H1	G No. (Option)	Weight (kg)	Collet
HSK 50A	HSK 50A-MDSK 6- 70	3.0~6.0	70	16.2	18.2	19.5	19.5	41.6	48	48	-	0.7	SK 6 A
	- 90		90		38.2		21.9		68	21~35	SKG- 8	1.0	
	-MDSK10- 70	3.0~10.0	70	18.2	19.2	27.5	27.5		46	46	-	0.7	SK10 A
	- 90		90		38.2		30.3		66	31~45	SKG-12S	1.0	
	-MDSK13- 90		90		22.0		40.0		33.0	35.6	66	66	
-MDSK16-115	3.0~16.0	115	23.0	24.0	40.0	40.0	54.0	91	45~70	SKG-18S	1.4	SK16 A	
HSK 63A	HSK 63A-MDSK 6- 75	3.0~6.0	75	16.2	18.0	19.5	19.5	52.4	50	21~28	SKG- 8	1.0	SK 6 A
	- 90		90		33.0		21.9		65	21~35		1.1	
	-105		105		48.0		24.0		80			1.4	
	-120		120		63.0		26.1		95			1.6	
	-MDSK10- 75	3.0~10.0	75	18.2	19.0	27.5	27.5		49	49	-	1.1	SK10 A
	- 90		90		33.0		29.6		64	31~40	SKG-12S	1.4	
	-105		105		48.0		31.7		79	31~50	1.6		
	-120		120		63.0		33.8		94	30~50	SKG-12L	1.8	
	-135		135		79.0		36.0		109		2.1		
	-MDSK13- 80	3.0~13.0	80	22.0	24.0	33.0	33.0		54	54	-	1.2	SK13 A
	- 90		90		33.0		34.6		64	64	1.5		
	-105		105		48.0		36.7		79	31~54	SKG-15	1.7	
	-120		120		63.0		38.8		94	1.9			
	-135		135		78.0		40.9		110	2.2			
	-MDSK16- 80	3.0~16.0	80	23.0	24.0	40.0	40.0		54	54	-	1.3	SK16 A
	- 90		90		34.2		41.6		64	64	1.5		
	-105		105		49.3		43.7		79	45~60	SKG-18S	1.7	
	-120		120		64.3		45.8		85		1.9		
	-135		135		79.0		47.9		105		SKG-18L	2.2	
	-MDSK20- 90	4.0~20.0	90	25.2	40.9	48.0	51.2		64	64	-	1.9	SK20 A
-105	105		54.3		51.1		79	79	2.1				
-120	120		70.0		50.6		94	47~70	SKG-22	2.4			
-135	135		85.8		51.2		105		2.5				
HSK 100A	HSK100A-MDSK 6-110	3.0~6.0	110	16.2	33.0	19.5	21.9	54.0	80	21~35	SKG- 8	3.9	SK 6 A
	-125		125		48.0		24.0		95			4.0	
	-140		140		63.0		26.1		110			4.1	
	-165		165		88.0		29.6		135			4.5	
	-MDSK10-110	3.0~10.0	110	18.2	33.0	27.5	29.8		80	30~50	SKG-12L	4.0	SK10 A
	-125		125		48.0		31.7		95			4.1	
	-140		140		63.0		33.8		110			4.2	
	-165		165		89.0		37.4		135			4.6	
	-MDSK13-110		3.0~13.0		110		22.0		33.0			33.0	
	-125	125		48.0	36.7	90			4.4				
	-140	140		63.0	38.8	105			31~54	4.5			
	-165	165		88.0	42.3	130			5.0				
	-MDSK16-125	3.0~16.0		125	23.0	51.0			40.0	44.0	87		45~65
	-140		140	66.0		46.1	104			45~70	4.8		
	-165		165	91.0		49.6	129			40~70	SKG-18L	5.3	
	-MDSK20-140	4.0~20.0	140	25.2	42.0	48.0	51.4		104	47~70	SKG-22	4.9	SK20 A
	-165		165		67.0		54.9		129	47~80		5.5	
	-MDSK25-140	8.0~25.4	140	27.0	43.0	55.0	57.3		104	55~75	SKG-28	4.9	SK25 A
	-165		165		69.0		60.9		129	55~85		5.6	

★Please use A type SK collet for the end milling operation. P.216 ★Please refer P.38, P.42 for the Jet coolant system, J type nut and cap.
 ★GH Handle is available as an option. P.30 Please order with the Code No. GH6: MDSK6 &, GH10:MDSK10, GH16:MDSK16, GH20:MDSK20, GH25:MDSK25
 ★Please add "P" at the end of Code No. for high speed specification, e.g HSK63A-MDSK10-75P
 ★Holder with an adjust screw for axial adjustment is supplied as an option. Please contact us.

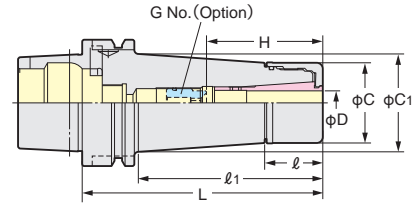


HSK ANNIVERSARY TYPE VC HOLDER



NEW

With TiN Bearing Nut
MAX.40,000min⁻¹ & G2.5
Run-Out Accuracy:3μm at 4D



VC
Centre Through
MAX. 7MPa

High Speed

PAT.

TAPER	Code No.	D	L	ℓ	ℓ ₁	C	C ₁	H	G No. (Option)	Weight (kg)	MAX. min ⁻¹	Collet
HSK 40A	HSK 40A-VC 6- 65, 90	2.0~6.0	65,90	23	45,70	28	33.6	-35~45	-VCG 6- 8A	0.4,0.6	40,000	VCK 6
	-VC13- 90, 120	3.0~12.0	90,120	29	70,100	40	40.0	-50~60	-VCG13-15A	0.7,1.0		VCK13
HSK 50A	HSK 50A-VC 6- 70, 90, 120	2.0~6.0	70,90,120	23	41,61,91	28	33.8,32.8,37.0	-,35~45	-,VCG 6- 8A	0.6,0.8,0.9	40,000	VCK 6
	-VC13- 90, 120	3.0~12.0	90,120	29	64,94	40	40.0	-50~60	-VCG13-15A	0.9,1.2		VCK13
HSK 63A	HSK 63A-VC 6- 70, 90, 120	2.0~6.0	70,90,120	23	41,61,91	28	33.8,32.8,37.0	-35~45,35~45	-VCG 6- 8A,VCG 6- 8A	0.9,1.0,1.2	30,000	VCK 6
	-VC13- 90, 120	3.0~12.0	90,120	29	61,92	40	44.5,48.8	-50~60	-VCG13-15A	1.2,1.6		VCK13
HSK 100A	HSK 100A-VC 6- 105, 135, 165	2.0~6.0	105,135,165	23	71,101,131	28	34.2,38.4,42.6	35~45	VCG 6- 8A	2.4,2.6,2.9	20,000	VCK 6
	-VC13- 105, 135, 165	3.0~12.0	105,135,165	29	71,101,131	40	45.9,50.1,54.3	-50~60,50~60	-VCG13-15A,VCG13-15A	2.7,3.1,3.6		VCK13

TAPER	Code No.	D	L	ℓ	ℓ ₁	C	C ₁	H	G No. (Option)	Weight (kg)	MAX. min ⁻¹	Collet
HSK 40E	HSK 40E-VC 6- 65, 90	2.0~6.0	65,90	23	45,70	28	34	-35~45	-VCG 6- 8A	0.5,0.7	40,000	VCK 6
	-VC13- 90, 120	3.0~12.0	90,120	29	70,100	40	40.0	-50~60	-VCG13-15A	0.8,1.1		VCK13
HSK 50E	HSK 50E-VC 6- 70, 90, 120	2.0~6.0	70,90,120	23	41,61,91	28	33.8,32.8,37.0	-35~45,35~45	-VCG 6- 8A,VCG 6- 8A	0.7,0.9,1.0	40,000	VCK 6
	-VC13- 90, 120	3.0~12.0	90,120	29	64,94	40	40.0	-50~60	-VCG13-15A	1.0,1.3		VCK13
HSK 63E	HSK 63E-VC 6- 70, 90, 120	2.0~6.0	70,90,120	23	41,61,91	28	33.8,32.8,37.0	-35~45,35~45	-VCG 6- 8A,VCG 6- 8A	1.0,1.1,1.3	30,000	VCK 6
	-VC13- 90, 120	3.0~12.0	90,120	29	61,92	40	44.5,48.8	-50~60	-VCG13-15A	1.3,1.7		VCK13

TAPER	Code No.	D	L	ℓ	ℓ ₁	C	C ₁	H	G No. (Option)	Weight (kg)	MAX. min ⁻¹	Collet
HSK 63F	HSK 63F-VC 6- 65, 90, 120	2.0~6.0	65,90,120	23	37,61,91	28	27.5,30.6,34.8	-35~45,35~45	-VCG 6- 8A,VCG 6- 8A	0.8,0.9,1.1	30,000	VCK 6
	-VC13- 90, 120	3.0~12.0	90,120	44	61,92	40	44.5,48.8	-50~60	-VCG13-15A	1.2,1.5		VCK13

- ★TiN Bearing Nut is supplied as standard.
- ★When the axial stopper is required, please use Adjust Screw (G No.).
- ★Collet, adjust screw (G No.) and GH Handle are available as an option. (P.30)
- The Code No. of the GH Handle is VC6:GH10, VC13:GH16
- ★HSK63A-VC6-150, HSK63A-VC13-150, HSK100A-VC13-90, -120 are available as an option.
- ★Please use VC J type Nut & Cap (P.43) for Centre Through Coolant application.
- The Code No. of VC J type Nut is VCN-6BJ, VCN-13BJ.
- The Code No. of the Cap is SKJ10-□, SKJ16-□
- When VC J type Nut is used, the total holder length will be extended to 6mm.
- ★All series are for High Speed Rotation.

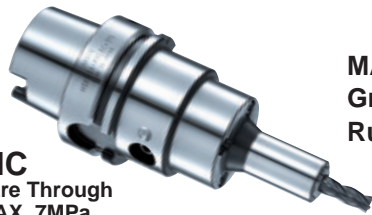
VCK Collet



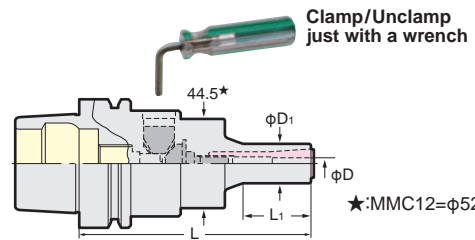
VCK Collet Code No.
VCK 6-2, 3, (3.175), 4, 5, 6
VCK13-3, (3.175), 4, 5, 6, 7, 8, 9, 10, 11, 12

- ★The acceptable shank tolerance of VCK collet is h₈.
- ★Inch series is also available.
- VCK 6-1/8, 3/16, 1/4 VCK13-1/8, 3/16, 1/4, 5/16, 3/8, 7/16, 1/2
- ★VCK6-3.175 is same as VCK6-1/8.
- ★VCK13-3.175 is same as VCK13-1/8.

HSK MINI-MINI CHUCK



MAX. 30,000min⁻¹ & G2.5
Gripping from Front Nose
Run-Out Accuracy within 3μm



MMC
Centre Through
MAX. 7MPa

High Speed

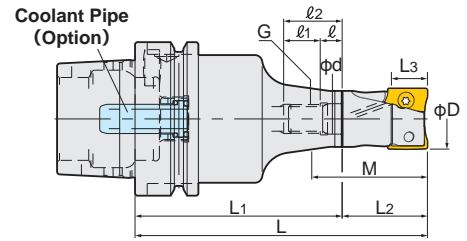
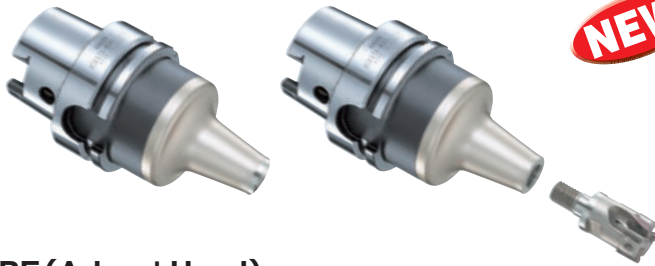
TAPER	Code No.	φD	L	φD ₁	L ₁	Collet	MAX. (min ⁻¹)	Weight(kg)
HSK50A	HSK 50A-MMC 8C-127	2~8	127	20	33	(PMK 8) (VMK 8)	30,000	1.4
	-MMC12C-129	4~12	129	30	36	(PMK12) (VMK12)		1.6
HSK63A	HSK 63A-MMC 8C-115	2~8	115	20	33	(PMK 8) (VMK 8)	30,000	1.4
	-MMC12C-117	4~12	117	30	35	(PMK12) (VMK12)		1.6
HSK100A	HSK 100A-MMC 8C-130	2~8	130	20	33	(PMK 8) (VMK 8)	20,000	2.9
	-MMC12C-130	4~12	130	30	36	(PMK12) (VMK12)		3.1

- ★Wrench is supplied as standard.
- ★PMK, VMK collet is available as an option. (P.32)

TAPER	Code No.	φD	L	D ₁	L ₁	Collet	MAX. (min ⁻¹)	Weight(kg)
HSK50E	HSK 50E-MMC 8C-127	2~8	127	20	33	(PMK 8) (VMK 8)	30,000	1.4
	-MMC12C-129	4~12	129	30	36	(PMK12) (VMK12)		1.6
HSK63E	HSK 63E-MMC 8C-115	2~8	115	20	33	(PMK 8) (VMK 8)	30,000	1.4
	-MMC12C-117	4~12	117	30	36	(PMK12) (VMK12)		1.6

TAPER	Code No.	φD	L	D ₁	L ₁	Collet	MAX. (min ⁻¹)	Weight(kg)
HSK63F	HSK 63F-MMC 8C-127	2~8	127	20	33	(PMK 8) (VMK 8)	30,000	1.4
	-MMC12C-129	4~12	129	30	36	(PMK12) (VMK12)		1.6

HSK



HSK-MDPE (Arbor+Head)

TAPER	Code No.	φD	L	L1	L2	MAX. Depth L3	M	Arbor Code No.	Head Code No.
HSK 63A	HSK 63A-MDPE16-100,120,135	16	100,120,135	70, 90,105	30	10	37.4	HSK 63A-MDPE-M 8- 70, 90,105	M 8-MDPE16-30
	-MDPE20-105,120,135	20	105,120,135	75, 90,105			40.0	-MDPE-M10- 75, 90,105	M10-MDPE20-30
	-MDPE25-105,120,135	25	105,120,135	70, 85,100	35	15	45.3,47.5,47.5	-MDPE-M12- 70, 85,100	M12-MDPE25-35
	-MDPE32-120,135,150	32	120,135,150	80, 95,110			52.5	-MDPE-M16- 80, 95,110	M16-MDPE32-40
HSK 100A	HSK100A-MDPE16-120,140,155	16	120,140,155	90,110,125	30	10	37.4	HSK100A-MDPE-M 8- 90,110,125	M 8-MDPE16-30
	-MDPE20-125,140,155	20	125,140,155	95,110,125			40.0	-MDPE-M10- 95,110,125	M10-MDPE20-30
	-MDPE25-125,140,155	25	125,140,155	90,105,120	35	15	45.3,47.5,47.5	-MDPE-M12- 90,105,120	M12-MDPE25-35
	-MDPE32-140,155,170	32	140,155,170	100,115,130			52.5	-MDPE-M16-100,115,130	M16-MDPE32-40

★2pcs of tip clamp bolt and tip clamp wrench are supplied as standard.
★Please refer to P.211 for cutting condition.

★Insert tip is available as an option. Please refer to P.171.
★Centre through tool coolant is available for all series.

HSK-MDPE-M (Arbor)

TAPER	Code No.	φD	L1	ID φd	Arbor Front Dia.	ℓ	ℓ1	ℓ2	Screw G
HSK 63A	HSK 63A-MDPE-M 8- 70, 90,105	16	70, 90,105	8.5	14.7	9	11	20	M 8
	-MDPE-M10- 75, 90,105	20	75, 90,105	10.5	18.7		12	21	M10
	-MDPE-M12- 70, 85,100	25	70, 85,100	12.5	23.0		15	24	M12
	-MDPE-M16- 80, 95,110	32	80, 95,110	17.0	30.0		16	25	M16
HSK 100A	HSK100A-MDPE-M 8- 90,110,125	16	90,110,125	8.5	14.7		11	20	M 8
	-MDPE-M10- 95,110,125	20	95,110,125	10.5	18.7		12	21	M10
	-MDPE-M12- 90,105,120	25	90,105,120	12.5	23.0		15	24	M12
	-MDPE-M16-100,115,130	32	100,115,130	17.0	30.0		16	25	M16

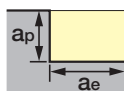
★Head is available as an option. P.171

★Centre through tool coolant is available for all series.

★This is interchangeable with DEPO. When the connection interface (Screw G and ID φd) is same, the cutter head of other carbide makers can be used.

CUTTING CONDITION of PRO-ENDMILL

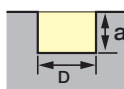
Side Milling



- The bold figures of cutting speed V (mm/min.) show the cutting speed when $a_e=0.5 \times D$. V (mm/min.) should be reduced to 80%, when $a_e=0.75 \times D$.
- Feed rate per 1 tooth/ 1 revolution f (mm/tooth) should be smaller, when a_p is getting larger. The feed rate of f (mm/tooth) shows the feed rate when $a_e=0.5 \times D$ & $a_p=MAX$.

Material	Mild Steel (SS400, S10C)	Carbon Steel (S45C, SCM440)	Cast Iron (FC300)	Ductile Cast Iron (FCD450)	Hardened Steel HRC40~55 (SKD)
Cutting Speed V	220 (140~270)	170 (110~210)	170 (110~210)	120 (80~150)	85 (50~100)
f	MDPE16	0.1 (0.1~0.15)		0.07 (0.07~0.1)	
	MDPE20	0.1 (0.1~0.25)		0.07 (0.07~0.2)	0.07 (0.07~0.15)
	MDPE25	0.1 (0.1~0.3)		0.07 (0.07~0.25)	0.07 (0.07~0.15)
	MDPE32	0.1 (0.1~0.3)		0.07 (0.07~0.25)	0.07 (0.07~0.15)

Groove Milling



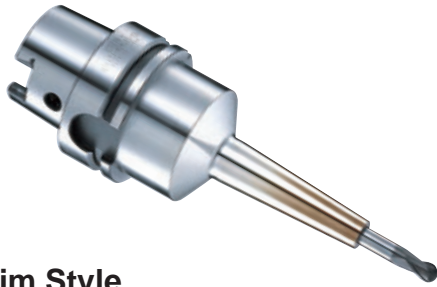
- Feed rate per 1 tooth/ 1 revolution f (mm/tooth) should be smaller, when a_p is getting larger. The feed rate of f (mm/tooth) shows the feed rate when $a_e=0.5 \times D$ & $a_p=MAX$.
- MAX. ramping angle is MDPE16: 15°, MDPE20: 9°, MDPE25: 11°, MDPE32: 7°

Material	Mild Steel (SS400, S10C)	Carbon Steel (S45C, SCM440)	Cast Iron (FC300)	Ductile Cast Iron (FCD450)	Hardened Steel HRC40~55 (SKD)
Cutting Speed V	180 (140~210)	140 (110~160)	100 (80~120)	100 (80~120)	70 (50~80)
f	MDPE16	0.1		0.07	
	MDPE20	0.07 (0.07~0.1)		0.07	
	MDPE25	0.07 (0.07~0.15)		0.07	
	MDPE32	0.07 (0.07~0.15)		0.07	

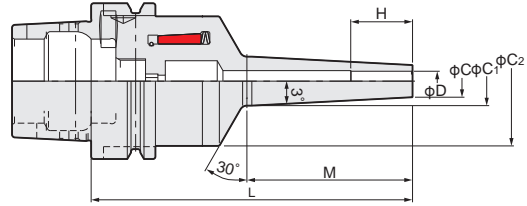


• Please clamp the insert tip with the suitable torque.
AOMT123608 : 1.0Nm , AOMT184808 : 4.0Nm

• For the guide line of insert tip life, the flank wear within 0.3mm under normal cutting will be recommended.



NEW



S Slim Style

TAPER	Code No.	φD	φC	φC ₁	φC ₂	L	M	H
HSK50A	HSK 50A-MDMS 3S-100, -125	3	6	10.2, 12.8	41.6	100, 125	42, 67	10
	-MDMS 4S-100, -125	4	7	11.2, 13.8				13
	-MDMS 6S-100, -125	6	9	13.2, 15.8				19
	-MDMS 8S-100, -125	8	13	17.2, 19.8				25
HSK63A	HSK 63A-MDMS 3S-105, -130	3	6	10.2, 12.8	52.4	105, 130	42, 67	10
	-MDMS 4S-105, -130	4	7	11.2, 13.8				13
	-MDMS 6S-105, -130	6	9	13.2, 15.8				19
	-MDMS 8S-105, -130	8	13	17.2, 19.8				25
	-MDMS10S-105, -130	10	16	20.2, 22.8				31
	-MDMS12S-105, -130	12	19	23.2, 25.8				31
HSK100A	HSK100A-MDMS 3S-150	3	6	12.8	54	150	67	10
	-MDMS 4S-125, -150	4	7	11.2, 13.8		125, 150	42, 67	13
	-MDMS 6S-125, -150	6	9	13.2, 15.8				19
	-MDMS 8S-125, -150	8	13	17.2, 19.8				25
	-MDMS10S-125, -150	10	16	20.2, 22.8				31
	-MDMS12S-125, -150	12	19	23.2, 25.8				31

R Standard

TAPER	Code No.	φD	φC	φC ₁	φC ₂	L	M	H
HSK50A	HSK 50A-MDMS 4R-100, -125	4	10	14.2, 16.8	41.6	100, 125	42, 67	13
	-MDMS 6R-100, -125	6	12	16.2, 18.8				19
	-MDMS 8R-100, -125	8	18	22.2, 24.8				25
	-MDMS10R-100	10	22	26.2				31
HSK63A	HSK 63A-MDMS 4R-105	4	10	14.2	52.4	105	42	13
	-MDMS 6R-105, -130	6	12	16.2, 18.8		105, 130	42, 67	19
	-MDMS 8R-105, -130	8	18	22.2, 24.8				25
	-MDMS10R-105, -130	10	22	26.2, 28.8				31
	-MDMS12R-105, -130	12	26	30.2, 32.8				
HSK100A	HSK100A-MDMS 6R-125, -150	6	12	16.2, 18.8	54	125, 150	42, 67	19
	-MDMS 8R-125, -150	8	18	22.2, 24.8				25
	-MDMS10R-125, -150	10	22	26.2, 28.8				
	-MDMS12R-125, -150	12	26	30.2, 32.8				31

★Please note the acceptable shank tolerance is h6.

★Carbide tool can be used and HSS tool can not be used.

★The tool will become very hot during heat shrinking. Please use glove for safety.

★ID=φ16, φ20 and φ25mm are available.

★The capacity of the drier is approx. 3KW.

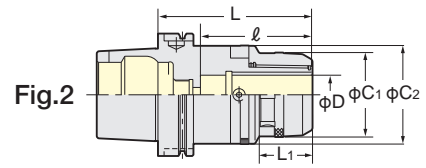
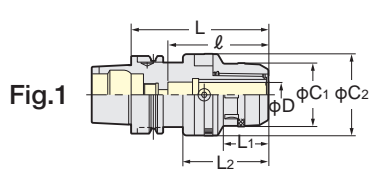
★Inductive style of the heat shrinking unit is recommended.

HSK ZERO FIT TYPE MILLING CHUCK

NIKKEN



NEW



CZF

PAT.

TAPER	Code No.	C1	C2	L	L1	L2	ℓ	Weight(kg)	Fig.	Collet
HSK 50A	HSK 50A-CZF20-115	51.5	66.5	115	35	73	80	1.8	1	KM20 CCK20
	HSK 63A-CZF20-110			110				2		
HSK 63A	-CZF25-110	59.5	74.5	110	35	68	80	2.5		KM25 CCK25
	-CZF32-130	69	80.5	130	42	88	105	2.8		
HSK 100A	HSK 100A-CZF20-115	51.5	66.5	115	35	-	80	3.5	2	KM20 CCK20
	-CZF25-115	59.5	74.5		35			80		
	-CZF32-115	69	80.5	42	83	4	KM32 CCK32			

★Spanner is available as an option. CZF20 type:9HC22, CZF25 type:9HC25, CZF32 type:9HC32
 ★Please note that the acceptable shank tolerance is h_6-h_7 .
 ★Wrench to adjust run-out (9ZFL) is available as an option.
 ★Please add "P" at the end of Code No. for High Speed Zero Fit Milling Chuck. e.g. HSK63A-CZF25-110P
 ★For How to Adjust the Run-Out, please refer P.156

★Please refer P.212 for KM, CCK collet.
 ★For Center Through Coolant application:
 Please use CKFN-D Nut for the direct chucking.
 Please use CCK collet and CKFN nut for chucking with collet.



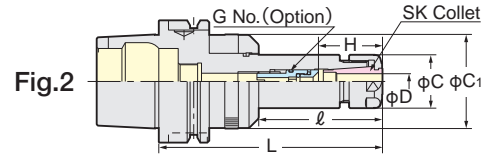
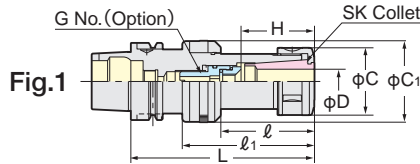
9ZFL

HSK ZERO FIT TYPE SLIM CHUCK

NIKKEN



NEW

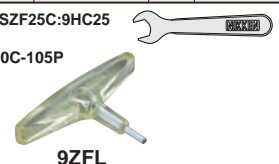


SZF

PAT.

TAPER	Code No.	D	L	ℓ	ℓ1	C	C1	H	G No. (Option)	Weight(kg)	Fig.	Collet
HSK 40A	HSK 40A-SZF 6C-105	0.7~6.0	105	32	70	19.5	40.5	26~31	SKG 6- 6HG	0.6	1	SK 6
	-SZF10C-105	1.75~10.0				27.5	48.5	35~41	SKG10-10HG	0.7		SK10
	-SZF16C-120	2.75~16.0				120	48	85	40	59.5		45~52
HSK 50A	HSK 50A-SZF 6C-120	0.7~6.0	120	68	-	19.5	40.5	26~31	SKG 6- 6HG	0.9	2	SK 6
	-SZF10C-120	1.75~10.0		46	78	27.5	48.5	35~41	SKG10-10HG	1.1		SK10
	-SZF16C-135	2.75~16.0	135	57	93	40	59.5	45~52	SKG16-10HG	1.5	1	SK16
-SZF25C-135	7.5~25.4	55				66.5	60~65	SKG25-18HGE	1.8	SK25		
HSK 63A	HSK 63A-SZF 6C-120	0.7~6.0	120	68	-	19.5	40.5	26~31	SKG 6- 6HG	1.2	2	SK 6
	-SZF10C-105, 150	1.75~10.0				105, 150	53, 98	27.5	48.5	35~41		SKG10-10HG
	-SZF16C-150	2.75~16.0	150	76	-	40	59.5	45~57	SKG16-12HG	2	1	SK16
	-SZF25C-135	7.5~25.4	135	57	93	55	66.5	60~65	SKG25-18HGE	2.1		SK25
HSK 100A	HSK 100A-SZF 6C-120	0.7~6.0	120	54	-	19.5	40.5	26~31	SKG 6- 6HG	2.4	2	SK 6
	-SZF10C-150	1.75~10.0				150	85	27.5	48.5	35~41		SKG10-10HG
	-SZF16C-150	2.75~16.0	40	59.5	45~57			SKG16-12HG	3.7	1	SK16	
	-SZF25C-150	7.5~25.4	55	66.5	60~65	SKG25-18HGE	4.1	SK25				

★Adjust screw (G No.), wrench to adjust run-out (9ZFL) and SKL spanner are available as an option. SZF6C:SKL-6W, SZF10C:SKL-10, SZF16C:9HC16, SZF25C:9HC25
 ★Spanner for run-out adjustment is available as an option. Code No. is 9ZFL.
 ★Please use "P" class or "A" type SK collet. P.216
 ★For High Speed type, Code No. is "GSZF-P". e.g. HSK63A-GSZF10C-105P
 ★For Centre Through Coolant application, please use SK J type nut and cap. P.43
 Please note that the total tool length with J type nut is extended 6mm longer. ★For How to Adjust the Run-Out, please refer P.156



9ZFL

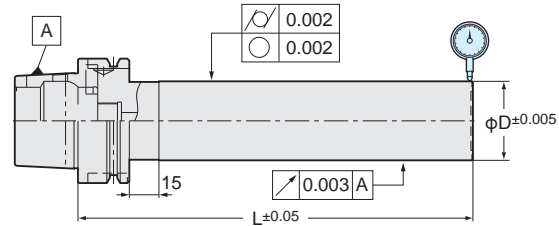
HSK TEST BAR

NIKKEN

Indispensable for checking your machine spindle.
Sub-zero treatment keeps accuracy to prevent from the deformation.
Each test bar is provided in a safety wooden box.



TB



Exact size of ϕD and L are marked on each test bar.

TAPER	Code No.	ϕD	L	Weight (Kg)	Run-out at total length	Circularity, Cylindricity
HSK 40A	HSK 40A-TB30-150	30	150	1.0	Within 0.003mm	Within 0.002mm
HSK 50A	HSK 50A-TB40-200	40	200	2.2		
HSK 63A	HSK 63A-TB40-200	40	200	2.4		
HSK100A	HSK100A-TB50-300	50	300	6.3		

★The different dimension of ϕd and L are available. e.g. HSK100A-TB50-400
But, the accuracy standard will be different. Please contact us.

The inspection certificate traceable to the national standard is available with charge.

HSK LUBRICATION PIPE

NIKKEN



TAPER	Lubrication Pipe Code No.		Wrench Code No. for Movable type*1
	Movable	Stationary	
HSK 40A	HSK 40-LP	HSK 40-LPS	HSK 40-LPL
HSK 50A	HSK 50-LP	HSK 50-LPS	HSK 50-LPL
HSK 63A	HSK 63-LP	HSK 63-LPS	HSK 63-LPL
HSK100A	HSK100-LP	HSK100-LPS	HSK100-LPL

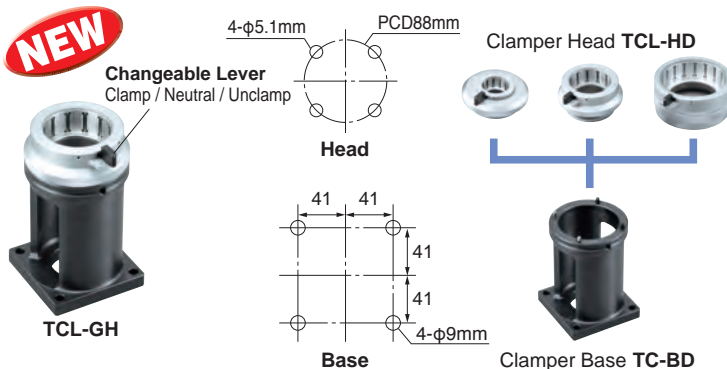
★Wrench for movable type marked *1 is as an option.
★Standard wrench can be used for stationary type.
★HSK40-LPS:W=5, HSK50-LPS:W=5, HSK63-LPS:W=6, HSK100-LPS:W=8
★Stationary type is popular but, movable type is used for the M/C of JTEKT, TSUGAMI, KOMATSU NTC or TAKIZAWA. Please check your M/C specification.

Caution

- For the HSK M/C with centre through coolant delivered via the tool clamping system, please make sure that the lubrication pipe is fitted in the rear of the HSK tool. This will prevent coolant from flooding the hollow chamber of the HSK Tool.
- For the HSK M/C without centre through coolant facility, but only external coolant source, care must be taken to prevent coolant from entering the front nose of chuck or collet slots and so contaminating the hollow area of the chuck. Please fit recommended plug.

TOOL CLAMPER for HSK TOOLING

NIKKEN



TCL-GH clamper is designed for symmetrical holders without drive key slots or U-groove. The TCL-GH clamper is also suitable for the other shank tooling with same flange diameter as E & F type. e.g. TCL-GH63 is suitable for HSK63A, 63E, 63F, BT40 and NC5-63. By changing the clamper heads to the suitable sizes, the same TCL-BD base can be used for the other sizes of shank.

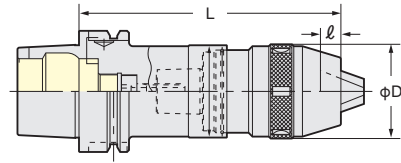
Clamper Code No.	Base Code No.	Head Code No.	Applicable Shank
TCL- 32GH	TCL-BD	TCL- 32HD	HSK 32E
TCL- 40GH		TCL- 40HD	HSK 40A, 40E
TCL- 46GH		TCL- 46HD	BT30, NC5-46
TCL- 50GH		TCL- 50HD	HSK 50A, 50E
TCL- 63GH		TCL- 63HD	HSK 63A, 63E, 63F, BT40, NC5-63
TCL-100GH		TCL-100HD	HSK100A, BT50, NC5-100

HSK

HSK NC DRILL CHUCK

NIKKEN

■ Compact, High Accuracy and Rigidity



NPU

ℓ : Chucking Length
 NPU 8 : 18.8mm
 NPU13 : 26.5mm

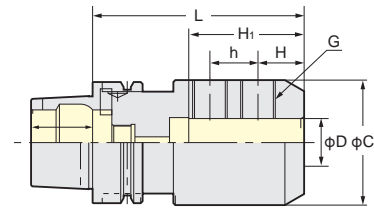
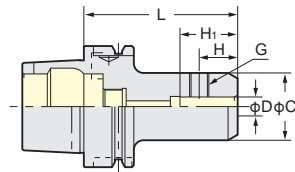
TAPER	Code No	Chucking Length φ mm	D	L		Weight(kg)
				MIN.	MAX.	
HSK 40A	HSK 40A-NPU 8-114	0.3~8	38	114	121	0.8
HSK 50A	HSK 50A-NPU 8-118	0.3~8	38	118	125	1.0
	-NPU13-135	1~13	48.5	135	147	1.5
HSK 63A	HSK 63A-NPU 8-120	0.3~8	38	120	127	1.3
	-NPU13-135	1~13	48.5	135	147	1.9
HSK100A	HSK100A-NPU 8-130	0.3~8	38	130	137	2.7
	-NPU13-145	1~13	48.5	145	157	3.4

★Wrench is available as an option. The Code No. of wrench is NPU8:NPUL-8, NPU13:NPUL-13
 ★Centre Through Coolant (MAX. 1MPa) is available for NPU13 style only. Please add "C" at the Code No. e.g. HSK63A-NPU13C-135

HSK SIDE LOCK HOLDER

NIKKEN

■ Simple and Rigid



SL

TAPER	Code No	φD	L	C	h	H	H1	G	Weight(kg)	
HSK 63A	HSK 63A-SLS 6- 80	6	80	25	-	18	25	M6	0.9	
	-SLS 8- 80	8		28			30	M8	0.9	
	-SLS10- 80	10		35			42	M10	1.0	
	-SLS12- 80	12		42		22.5	46	M12	1.2	
	-SLS16- 80	16		48		24	52	M14	1.3	
	-SLS20- 80	20		52		25	52	M16	1.4	
	-SLS25-110	25	110	65	25	24	70	M18	1.8	
	-SLS32-110	32		72	28		75	M20	2.6	
HSK100A	HSK100A-SLS 6- 80	6	80	25	-	18	25	M6	2.3	
	-SLS 8- 80	8		28			30	M8	2.3	
	-SLS10- 80	10		35			42	M10	2.4	
	-SLS12- 80	12		42		22.5	49	M12	2.6	
	-SLS16-100	16		100		48	24	52	M14	3.0
	-SLS20-100	20				52	25	54	M16	3.1
	-SLS25-100	25	65		25	65	M18	3.7		
	-SLS32-100	32	72	28	24	68	M20	3.9		

★JIS B4005 end mill can be gripped.
 ★The Code No. for ultra heavy duty combination shank end mill is "DM". e.g. HSK100A-DM50.8-120

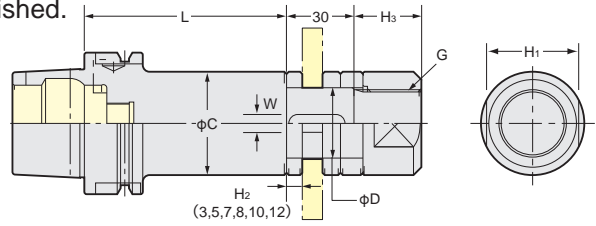


HSK STUB ARBOR

NIKKEN



■ Reliable Milling with No Chattering Accomplished.



SCA

Inch Series

(●) shows for Metric Series.

Metric Series

TAPER	Code No.	D	L	C	W	H ₁	H ₃	G	Weight(kg)	Code No.
HSK 63A	HSK 63A-SCA25.4 -90	25.4 (27)	90	40	6.35 (7)	32	25	M24	1.8	HSK 63A-SCA27-90
	SCA31.75-90	31.75 (32)		46	7.92 (8)	41	30	M30	2.3	HSK 63A-SCA32-90
HSK100A	HSK100A-SCA25.4 -90	25.4 (27)	90	40	6.35 (7)	32	25	M24	3.2	HSK100A-SCA27-90
	SCA31.75-90	31.75 (32)		46	7.92 (8)	41	30	M30	3.7	HSK100A-SCA32-90

★JIS B4206, JIS B4107, JIS B4219, JIS B4109 cutters can be attached.

★Key and collars (H₂=3, 5, 7, 8, 10, 12mm) are supplied as standard. For Code No. of collar and nut, please refer to P.104.

HSK TAPPER CHUCK

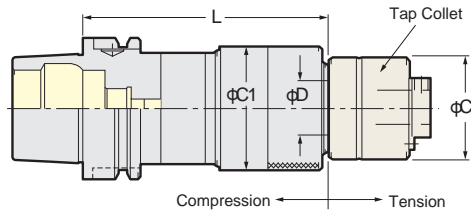
NIKKEN

HSK

■ With the axial NC floating system.



Z



TAPER	Code No.	Tapping Capability			D	C	C ₁	Tap Collet	Weight (kg)
		M	U	P					
HSK 63A	HSK 63A-Z 8-115*1	M 2~M 8	1/8~1/4	—	13	23	33	ZKN 8	2.7
	-Z12-120	M 3~M12	1/8~1/2	P 1/8	19	32	45	ZKG12	3.2
	-Z16-130	M 3~M16	1/8~5/8	P 1/8~3/8	25	39	55	ZKG16	4.3
	-Z24-140	M 8~M24	1/2~1	P 1/4~5/8	30	46	68	ZKG24	4.7
	-Z38-190	M18~M38	3/8~1 3/8	P 3/8~1	45	78	85	ZKN38	8.2
HSK100A	HSK100A-Z 8-120*1	M 2~M 8	1/8~1/4	—	13	23	33	ZKN 8	3.5
	-Z12-125	M 3~M12	1/8~1/2	P 1/8	19	32	45	ZKG12	3.6
	-Z16-140	M 3~M16	1/8~5/8	P 1/8~3/8	25	39	55	ZKG16	5.0
	-Z24-150	M 8~M24	1/2~1	P 1/4~5/8	30	46	68	ZKG24	5.8
	-Z38-190	M18~M38	3/8~1 3/8	P 3/8~1	45	78	85	ZKN38	8.3
	-Z65-215	M36~M100	1~3 3/4	P 1~3	68	110(125)	110	ZKN65	9.0

★Marked *1 Z8 Tapper Chuck and ZK8 Tap Collet are available as semi-standard.

★Please refer to P.51 for ZKG/ZKN tap collet.

★For Synchronized Tapping

ZH Tapper Chuck without tension/compression mechanism is available. It improves tap life remarkably by absorbing fine error completely with the small floating mechanism. Please use ZMK Tap Collet without torque-limited mechanism P.58 only for ZH Tapper Chuck.

★High pressure centre through tool coolant type and oil mist type are available. But, OZMK Tap Collet must be used. Please contact us.



ZH Tapper Chuck + ZMK Tap Collet

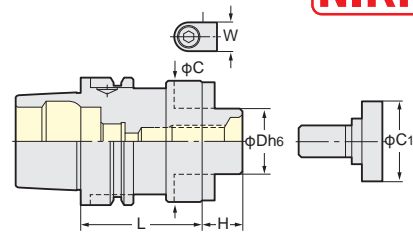
e.g. HSK 40A-ZH12CH-100
 HSK 50A-ZH12CH-100
 HSK 63A-ZH12CH-100
 -ZH24CH-130
 HSK100A-ZH12CH-105
 -ZH24CH-130

HSK FACE MILL ARBOR

NIKKEN



■ FMA: JIS B 4113 Face Mill Cutter
 ■ FMC: Shoulder Cutter (SANDVIK, SUMITOMO etc.)



FMA, FMC

TAPER	Code No.	Dimensions						Drive key	Lock bolt	Weight (kg)
		D	L	H	C	C1	W			
HSK 40A	HSK 40A-FMA25.4 -50	25.4	50	22	50	33	9.5	FW5	FM12	0.7
HSK 50A	HSK 50A-FMA25.4 -55	25.4	55	22	50	33	9.5	FW5	FM12	0.8
HSK 63A	HSK 63A-FMA25.4 -50	25.4	50	22	50	33	9.5	FW5	FM12	1.2
	-FMA31.75-60	31.75	60	30	60	40	12.7	FW13	FM16	1.6
	-FMA38.1 -60	38.1		34	80	50	15.9	FW18	FM20	1.8
HSK100A	HSK100A-FMA25.4 -50	25.4	50	22	50	33	9.5	FW5	FM12	2.4
	-FMA31.75-75	31.75	75	30	70	40	12.7	FW13	FM16	3.4
	-FMA38.1 -75	38.1		34	80	50	15.9	FW19	FM20	3.8
	-FMA50.8 -75	50.8		36	100	65	19	FW24	FM24	4.4
	-FMA47.625-75	47.625		-	128.57	-	25.4	FW26	*	5.3

★The arbor marked * requires 4 fixing bolts. (M16)

TAPER	Code No.	Dimensions						Drive key	G Cap bolt	Weight (kg)
		D	L	H	C	C1	W			
HSK 40A	HSK 40A-FMC22-50	22	50	18	45	16	10	FW 8	M10×30	0.6
HSK 50A	HSK 50A-FMC22-50	22	50	18	45	16	10	FW 8	M10×30	0.7
	-FMC27-60	27	60	20	60	18	12	FW11	M12×35	1.1
HSK 63A	HSK 63A-FMC22-45, 60	22	45, 60	18	45	16	10	FW 8	M10×30	1.0, 1.2
	-FMC27-60	27	60	20	60	18	12	FW11	M12×35	1.4
	-FMC32-60	32		22	80	24	14	FW16	M16×35	1.9
HSK100A	HSK100A-FMC22-50	22	50	18	45	16	10	FW 8	M10×30	2.4
	-FMC27-50	27		20	60	18	12	FW11	M12×35	2.6
	-FMC32-75	32	75	22	80	24	14	FW16	M16×35	3.4

★Drive key, L-Wrench & Bolts are supplied as standard.

★The bolt may not be the same as above table, please use the bolt specified by the cutter maker.

★Extended length Face Mill Arbors are available as an option.

HSK100A-FMA25.4 -200, 250

-FMA31.75-150, 200

-FMA38.1 -150, 200

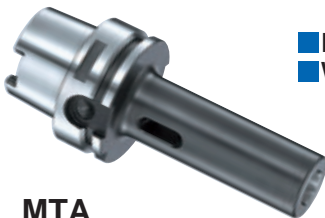
★Above weight is for arbor only. (Not include Face Mill Cutter)

★In case of the special cutter, please specify the dimension below.

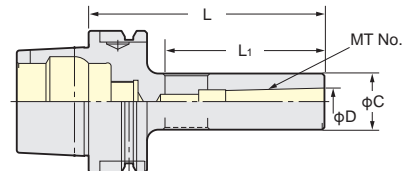
★In case of the special cutter, please specify the dimensions below.

HSK MORSE TAPER ADAPTER A TYPE

NIKKEN



■ For Drill & Reamer with MT1~MT5 Shank.
 ■ With Side Lock Screw.



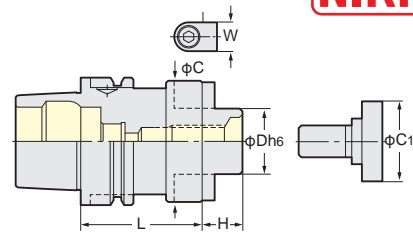
MTA

TAPER	Code No.	MT.No.	D	C	L1	Weight(kg)
HSK 63A	HSK 63A-MTA1-105	1	12.065	25	74	0.9
	-MTA2-120	2	17.780	32	89	1.1
	-MTA3-150	3	23.825	40	119	1.6
	-MTA4-165	4	31.267	50	136	2.2
HSK100A	HSK100A-MTA1-110	1	12.065	25	71	2.3
	-MTA2-125	2	17.780	32	86	2.3
	-MTA3-140	3	23.825	40	106	2.8
	-MTA4-165	4	31.267	50	131	3.6
	-MTA5-195	5	44.399	65	161	4.9

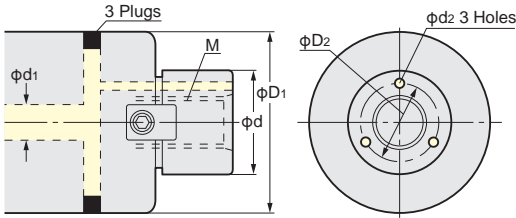
HSK FMH FACE MILL ARBOR



■ For Oil Hole Cutter
For High Feed Cutter



FMH



Code No.	Cutter Dia.	φd	φD1	M	Coolant Hole		
					φD2	φd1	φd2
FMH22 (22.225)	φ50, φ52 φ63, φ66	22(22.225)	47 60	M10×1.5	16	6~8	3
FMH27 (25.4)	φ80	27(25.4)	76(70)	M12×1.75	19.5(18.5)	8~10	3.5
FMH32 (31.75)	φ100	32(31.75)	96	M16×2.0	24	10~13	4
FMH40 (38.1)	φ125	40(38.1)	100	M20×2.5	30(29)	10~15	5
FMH50.8	φ160	50.8	100	M24×3.0	37.5	15~20	7

FMH Inch Series

★Fixing dimension is basically based on FMA/FMC. ★The combination of the other cutter dia. are also available.

TAPER	Code No.	Arbor						Driver Key	Lock Bolt	G Cap Bolt	Weight (kg)		
		D	L	H	C	C1	W						
HSK 63A	HSK 63A-FMH22.225 - 47 - 45	22.225	45	17	47	28	8	FW 3	FM10	—	1.1		
	- 60		60								1.3		
	- 90		90								1.7		
	HSK 63A	-FMH25.4 - 70 - 60	25.4	60	22	70	33	9.5	FW 5	FM12	—	2.5	
		- 90		90								1.8	
		- 150		150								2.5	
HSK 63A		-FMH31.75 - 76 - 60	31.75	60	30	76	40	12.7	FW13	FM16	—	2.0	
		- 90		90								2.7	
		- 150		150								4.1	
	HSK100A	HSK100A-FMH22.225 - 47 - 105	22.225	105	17	47	28	8	FW 3	FM10	—	3.4	
		- 150		150								4.0	
		- 200		200								4.7	
HSK100A		-FMH22.225 - 60 - 60	22.225	60	17	60	28	8	FW 3	FM10	—	2.9	
		- 105		105								3.9	
		- 150		150								4.9	
		HSK100A	-FMH25.4 - 70 - 60	25.4	60	22	70	33	9.5	FW 5	FM12	—	6.1
			- 90		90								7.2
			- 150		150								9.9
HSK100A			-FMH31.75 - 76 - 60	31.75	60	30	76	40	12.7	FW13	FM16	—	7.4
			- 90		90								11.8
			- 105		105								11.8
		HSK100A	-FMH38.1 - 100 - 60	38.1	60	34	100	50	15.9	FW19	FM20	—	4.1
			- 90		90								5.9
			- 105		105								6.8
HSK100A			- 150	150	9.6								

FMH Metric Series

TAPER	Code No.	Arbor						Driver Key	Lock Bolt	G Cap Bolt	Weight (kg)		
		D	L	H	C	C1	W						
HSK 63A	HSK 63A-FMH16 - 37 - 45	16	45	17	37	20	8	FW 3	FM 8	—	1.0		
	-FMH22 - 47 - 45	22	45	18	47	16	10	FW 8	—	M10×30	1.1		
	- 60		60								1.3		
	- 90		90								1.7		
	HSK 63A	-FMH27 - 60 - 60	27	60	20	60	18	12	FW11	—	M12×35	1.6	
- 90		90		2.3									
- 150		150		3.4									
HSK100A		HSK100A-FMH22 - 47 - 105	22	105	18	47	16	10	FW 8	—	M10×30	4.0	
		- 150		150								4.7	
	- 200	200		5.4									
	HSK100A	-FMH22 - 60 - 60	22	60	18	60	16	10	FW 8	—	M10×30	2.9	
		- 105		105								3.9	
		- 150		150								5.4	
		HSK100A	-FMH27 - 60 - 60	27	60	20	60	18	12	FW11	—	M12×35	2.9
			- 90		90								3.7
			- 150		150								5.0
	HSK100A		-FMH27 - 76 - 60	27	60	20	76	18	12	FW11	—	M12×35	3.2
			- 90		90								4.3
			- 150		150								6.5
HSK100A		-FMH32 - 96 - 60	32	60	22	96	24	14	FW16	—	M16×35	3.8	
		- 90		90								5.5	
		- 150		150								8.9	
	HSK100A	-FMH40 - 100 - 75	40	75	26	100	50	16	FW22	FM20	—	4.9	
		- 105		105								6.8	

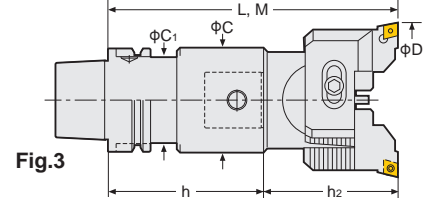
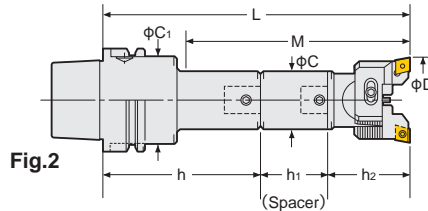
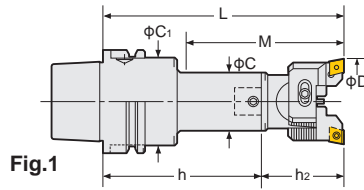
HSK BALANCE-CUT BORING ARBOR (RAC-E)

NIKKEN

Rough Boring — For Steel, Stainless Steel and Cast Iron
CC Insert (Positive type)



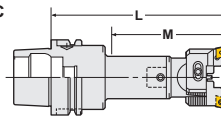
RAC-E



TAPER	Code No.	Boring Range D	Boring Depth M	C	C ₁	Shank Code No.	Spacer Code No.	P.228		Weight (kg)	Fig
								Head Code No.	Tip No.		
HSK63A	HSK 63A-RAC25-135E	25~32	67	15	24	HSK 63A-Q12- 80	—	12-RAC025- 55E	CC07-C	1.7	1
	-165E		105			-Q12-110				1.8	
	-180E		112			-Q12- 80				1.8	
	-RAC32-150E	32~45	77	19	30	-Q16- 95	—	16-RAC 32- 55E	CC08-C	2.1	1
	-180E		110			-Q16-125				2.3	
	-195E		122			-Q16- 95				2.3	
	-RAC43-150E	43~55	97	40	50	-Q20- 80	—	20-RAC 43- 70E	—	2.4	1
	-180E		130			-Q20-110				2.6	
	-210E		157			-Q20- 80				2.9	
	-RAC53-165E	53~70	135	53	50	-Q26- 95	—	26-RAC 53- 70E	CC12-C	2.2	1
	-210E		180			-Q26-140				3.0	
	-225E		195			-Q26- 95				2.9	
	-RAC70-180E	70~100	180	64	52.4	-Q34- 95	—	34-RAC 70- 85E	—	4.5	3
	-195E		195			-Q34-110				4.9	
	-RAC100-195E		100~130			195				83	

- ★“C” grade (Coated) inserts are supplied as standard with the head. P.62 Please refer P.93 for cutting condition.
- ★Please refer P.243 for base holder, P.86 for spacer and P.67 for head.
- ★For centre through tool coolant type, please add “-C” at the end of Code No. e.g. HSK63A-RAC53-165E-C
- ★For HSK40A or 50A, modular connection system is applied. Please refer P.243 for Base Holder.
- ★When L length is required longer than standard, please specify the boring depth M.

★Code No. of RAC25 and RAC32 are changed to RAC25E and RAC32E.
e.g. HSK63A-RAC25-135 → HSK63A-RAC25E-135E
12-RAC25- 55 → 12-RAC25E- 55E



High Pressure Coolant Through Tool

HSK BALANCE-CUT BORING ARBOR (RAC-E)



Balance cut boring bar executes boring in 2 cartridge inserts absorbing the vibration each other. The faster the feed rate, the better swarf ejection. This is ideal for rough and medium boring.

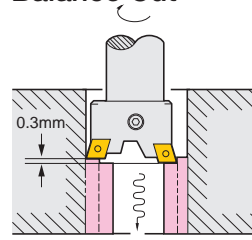
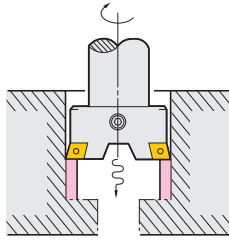
Double Cutting Capability

Please use RAC-K for through hole boring.

☞ P.233, P.234

Example of 2 Stepped Balance Cut

Approx. double removal of below cutting condition is possible by -0.3 Cartridge. ☞ P.70



TAPER	Code No.	Boring Range D	Boring Depth M	C	C ₁	Shank Code No.	Spacer Code No.	P.228		Weight (kg)	Fig
								Head Code No.	Tip No.		
HSK100A	HSK100A-RAC 25-150E	25~32	67	15	24	HSK100A-Q12- 95	—	12-RAC025- 55E	CC07-C	3.9	1
	-180E		105			-Q12-125				4.1	
	-195E		112			-Q12- 95				4.0	2
	-RAC 32-180E	32~45	77	31	50	-Q16-125N	—	16-RAC 32- 55E	CC08-C	4.6	1
	-210E		110			-Q16-155				4.8	
	-225E		122			-Q16-125N				4.8	2
	-RAC 43-180E	43~55	97	40	60	-Q20-110	—	20-RAC 43- 70E	—	4.9	1
	-195E		130			-Q20-125				5.0	
	225E		142			-Q20-110				5.3	2
	-240E		157			-Q20-110				5.4	
	-RAC 53-210E	53~70	117	53	65	-Q26-140	—	26-RAC 53- 70E	—	6.1	1
	-240E		182			-Q26-170N				6.2	
	-270E		177			-Q26-140				6.8	2
	-RAC 70-255E	70~100	202	64	80	-Q34-170	—	34-RAC 70- 85E	—	8.7	1
	-285E		232			-Q34-200				9.1	
	-315E		262			-Q34-170				10.1	2
	-RAC100-225E		225			-Q42-125				11.7	1
	-290E	290	-Q42-190	11.7							
	-315E	315	-Q42-125	15.1	2						

★“C” grade (Coated) inserts are supplied as standard with the head. ☞ P.62 Please refer ☞ P.95 for cutting condition. ★Code No. of RAC25 and RAC32 with CC inserts are changed to RAC25E and RAC32E.
 ★Please refer ☞ P.243 for base holder, ☞ P.86 for spacer and ☞ P.69 for head. e.g. HSK100A-RAC25-150 → HSK100A-RAC25-150E
 ★For centre through tool coolant type, please add“-C”at the end of Code No. e.g. HSK100A-RAC53-210E-C
 ★HSK100A-RAC100-375E, 425E and 475E are also available. 12-RAC25- 55 → 12-RAC25- 55E

Insert tip for RAC-E

● : best ○ : good

Material	Steel		●	
	Stainless Steel		●	
	Cast Iron		○	●
Aluminium				
		Coated Carbide M	Coated Carbide K	
		Grade	C	
		Material	AC630M	AC410K
Applicable Arbor	Dimension	Code No.	Nose R	
RAC025E		CC07-○0.4	0.4	●
		CC07-○0.8	0.8	●
RAC25E, RAC32E		CC08-○0.4	0.4	●
		CC08-○0.8	0.8	●
RAC43E - RAC530E		CC12-○0.4	0.4	●
		CC12-○0.8	0.8	●

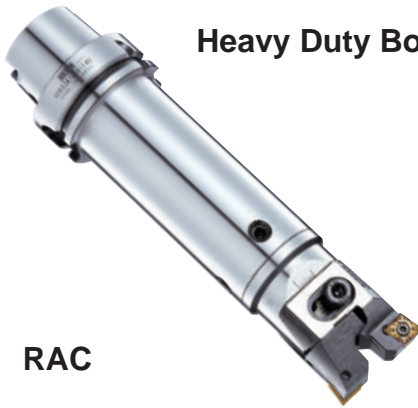
Please add the grade indication into ○, and add the insert tip material indication at the end off the Code No. e.g. CC12-C8(AC630M)

★Minimum order quantity : 10pcs.

HSK BALANCE-CUT BORING ARBOR (RAC)

NIKKEN

Rough Boring — For Heavy Duty Boring of Iron and Cast Iron
CN Insert (Negative type)



Heavy Duty Boring

RAC

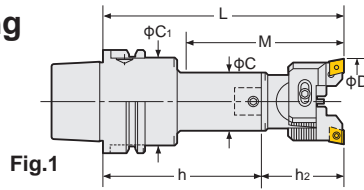


Fig.1

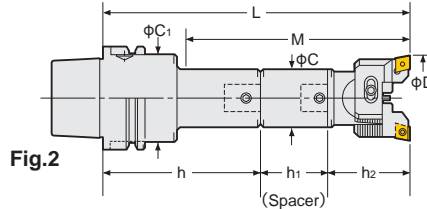


Fig.2

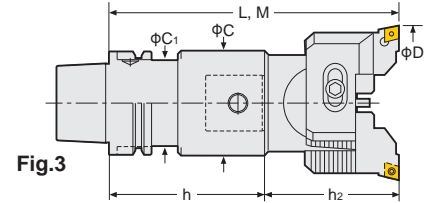
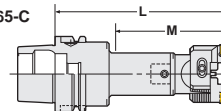


Fig.3

TAPER	Code No.	Boring Range D	Boring Depth M	C	C ₁	Shank Code No.	Spacer Code No.	P.230		Weight (kg)	Fig
								Head Code No.	Tip No.		
HSK63A	HSK 63A-RAC43-150	43~55	97	40	50	HSK 63A-Q20- 80	—	20-RAC 43- 70	CN08-C	2.4	1
	-180		130			—	2.6				
	-210		157			SP20-20-60	2.9			2	
	-RAC53-165	53~70	135	53	-Q26- 95	—	26-RAC 53- 70	CN08-C	2.2	1	
	-210		180		—	3.0					
	-225		195		SP26-26-60	2.9			2		
	-RAC70-180	70~100	180	64	52.4	-Q34- 95	—	34-RAC 70- 85	CN08-C	4.5	3
	-195		195			—				4.9	
	-RAC100-195		100~130			195				83	

- ★“C” grade (Coated) inserts are supplied as standard with the head. P.64 Please refer P.95 for cutting condition.
- ★Please refer P.243 for base holder, P.86 for spacer and P.69 for head.
- ★For centre through tool coolant type, please add“-C” at the end of Code No. e.g. HSK63A-RAC53-165-C
- ★For HSK40A or 50A, modular connection system is applied. Please refer P.243 for Base Holder.
- ★When L length is required longer than standard, please specify the boring depth M.

★Code No. of RAC25 and RAC32 with CC inserts are changed to RAC25E and RAC32E. Please refer P.61, P.62



High Pressure Coolant Through Tool

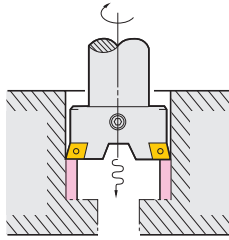
HSK BALANCE-CUT BORING ARBOR (RAC)



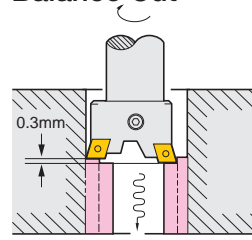
Balance cut boring bar executes boring in 2 cartridge inserts absorbing the vibration each other. The faster the feed rate, the better swarf ejection. This is ideal for rough and medium boring.

Double Cutting Capability

Please use RAC-K for through hole boring. P.233, P.234



Example of 2 Stepped Balance Cut



Approx. double removal of below cutting condition is possible by **-0.3 Cartridge**. P.70

TAPER	Code No.	Boring Range D	Boring Depth M	C	C ₁	Shank Code No.	Spacer Code No.	P.230		Weight (kg)	Fig
								Head Code No.	Tip No.		
HSK100A	HSK100A-RAC 43-180	43~55	97	40	60	HSK100A-Q20-110	—	20-RAC 43- 70	CN08-C	4.9	1
	-195		130			-Q20-125				5.0	
	225		142			-Q20-110				5.3	
	-240		157			-Q20-110				5.4	
	-RAC 53-210		117			-Q26-140				6.1	
	-240	182	-Q26-170N	6.2	26-RAC 53- 70	1					
	-270	177	-Q26-140	6.8	SP26-26-60	2					
	-RAC 70-255	202	-Q34-170	8.7	34-RAC 70- 85	1					
	-285	232	-Q34-200	9.1							
	-315	262	-Q34-170	10.1			SP34-34-60	2			
	-RAC100-225	225	-Q42-125	11.7	42-RAC100-100	1					
	-290	290	-Q42-190	11.7							
	-315	315	-Q42-125	15.1			SP42-42-90	2			

★“C” grade (Coated) inserts are supplied as standard with the head. P.64 Please refer P.95 for cutting condition. ★Code No. of RAC25 and RAC32 with CC inserts are changed to RAC25E and RAC32E. Please refer P.61, P.62
 ★Please refer P.243 for base holder, P.86 for spacer and P.69 for head.
 ★For centre through tool coolant type, please add“-C”at the end of Code No. e.g. HSK100A-RAC53-210-C
 ★HSK100A-RAC100-375, 425 and 475 are also available.

Insert tip for RAC for Heavy Duty Boring

Material	Steel	●		
	Stainless Steel	●		
	Cast Iron	●		
	Aluminium	●		
	Coated Carbide M			
	Grade	C		
	Material	AC630M		
Applicable Arbor	Dimension	Code No.	Nose R	
RAC43 - RAC530		CN08-○8	0.8	●

Please add the grade indication into ○, and add the insert tip material indication at the end off the Code No. e.g. CC08-C8(AC630M)

★Minimum order quantity : 10pcs.
 ★When CN08 insert (CN○○1204○○) in the market is used, please use the eccentric bolt type cartridge (S.RCC-○○Q) P.92. Nikken CN08-○8 insert can be used on the eccentric bolt type cartridge.

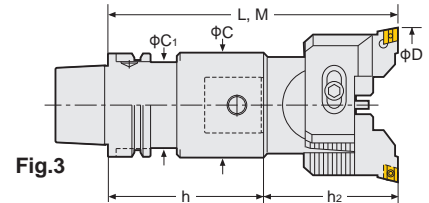
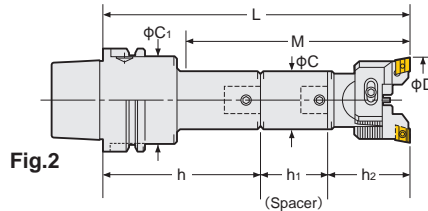
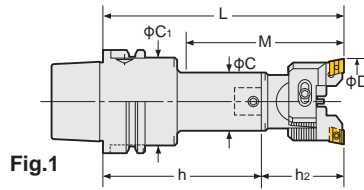
HSK BALANCE-CUT BORING ARBOR (RAC-A)

NIKKEN

Rough Boring—For Aluminium



RAC-A



TAPER	Code No.	Boring Range D	Boring Depth M	C	C ₁	Shank Code No.	Spacer Code No.	P.232		Weight (kg)	Fig		
								Head Code No.	Tip No.				
HSK63A	HSK 63A-RAC25-135A	25~32	67	15	24	HSK 63A-Q12- 80	—	12-RAC 25- 55A	AEG12	1.7	1		
	-165A		105			-Q12-110						1.8	
	-180A		112			-Q12- 80						SP12-12-45	1.8
	-RAC32-150A	32~45	77	19	30	-Q16- 95	—	16-RAC 32- 55A	AEG12	2.1	1		
	-180A		110			-Q16-125						SP16-16-45	2.3
	-195A		122			-Q16- 95							2.3
	-RAC43-150A	43~55	97	40	50	-Q20- 80	—	20-RAC 43- 70A	AEG16	2.4	1		
	-180A		130			-Q20-110						SP20-20-60	2.6
	-210A		157			-Q20- 80							2.9
	-RAC53-165A	53~70	135	53	50	-Q26- 95	—	26-RAC 53- 70A	AEG16	2.2	1		
	-210A		180			-Q26-140						SP26-26-60	3.0
	-225A		195			-Q26- 95							2.9
	-RAC70-180A	70~100	180	64	52.4	-Q34- 95	—	34-RAC 70- 85A	AEG16	4.5	3		
	-195A		195			-Q34-110						4.9	
-RAC100-195A	100~130		195			83						-Q42- 95	42-RAC100-100A

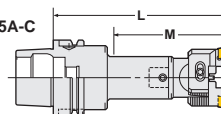
★“F” grade inserts are supplied as standard with the head. Please refer P.66 for cutting condition.

★Please refer P.243 for base holder, P.86 for spacer and P.69 for head.

★For centre through tool coolant type, please add “-C” at the end of Code No. e.g. HSK63A-RAC53-165A-C

★For HSK40A or 50A, modular connection system is applied. Please refer P.243 for Base Holder.

★When L length is required longer than standard, please specify the boring depth M.



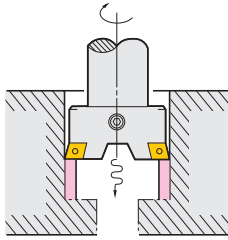
High Pressure Coolant Through Tool

HSK BALANCE-CUT BORING ARBOR (RAC-A)

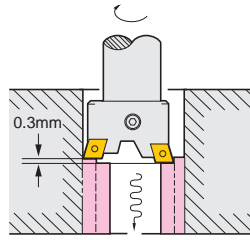


Balance cut boring bar executes boring in 2 cartridge inserts absorbing the vibration each other. The faster the feed rate, the better swarf ejection. This is Ideal for rough and medium boring.

Double Cutting Capability



Example of 2 Stepped Balance Cut



Approx. double removal of below cutting condition is possible by **-0.3 Cartridge**.
 ☞ P.70

TAPER	Code No.	Boring Range D	Boring Depth M	C	C ₁	Shank Code No.	Spacer Code No.	P.232		Weight (kg)	Fig	
								Head Code No.	Tip No.			
HSK100A	HSK100A-RAC 25-150A	25~32	67	15	24	HSK100A-Q12- 95	—	12-RAC 25- 55A	AEG12	3.9	1	
	-180A		105			-Q12-125				4.1		
	-195A		112			-Q12- 95				SP12-12-45	4.0	2
	-RAC 32-180A	32~45	77	31	50	-Q16-125N	—	16-RAC 32- 55A	AEG12	4.6	1	
	-210A		110			-Q16-155				4.8		
	-225A		122			-Q16-125N				SP16-16-45	4.8	2
	-RAC 43-180A	43~55	97	40	60	-Q20-110	—	20-RAC 43- 70A	AEG16	4.9	1	
	-195A		130			-Q20-125				5.0		
	225A		142			-Q20-110				SP20-20-45	5.3	2
	-240A		157			-Q20-110				SP20-20-60	5.4	
	-RAC 53-210A	53~70	117	53	65	-Q26-140	—	26-RAC 53- 70A	AEG16	6.1	1	
	-240A		182			-Q26-170N				6.2		
	-270A		177			-Q26-140				SP26-26-60	6.8	2
	-RAC 70-255A	70~100	202	64	80	-Q34-170	—	34-RAC 70- 85A	AEG16	8.7	1	
	-285A		232			-Q34-200				9.1		
	-315A		262			-Q34-170				SP34-34-60	10.1	2
	-RAC100-225A		225			-Q42-125				—	11.7	1
	-290A	290	-Q42-190	—	11.7							
	-315A	315	-Q42-125	SP42-42-90	15.1	2						

★“F” grade inserts are supplied as standard with the head. ☞ P.66 Please refer ☞ P.95 for cutting condition.
 ★Please refer ☞ P.243 for base holder, ☞ P.86 for spacer and ☞ P.69 for head.
 ★For centre through tool coolant type, please add“C”at the end of Code No. e.g. HSK100A-RAC53-210A-C
 ★HSK100A-RAC100-375A, 425A and 475A are also available.

Insert tip for RAC-A

Material	Steel		Code No.	Nose R	Material
	Stainless Steel	Cast Iron			
Material	Aluminium		AEG12-○1	0.1	Coated Carbide K
					F
Applicable Arbor	Dimension		AEG12-○2	0.2	KW10
			AEG12-○4	0.4	
RAC25A, RAC32A	 (AEGT090304L)		AEG16-○1	0.1	●
			AEG16-○2	0.2	
			AEG16-○4	0.4	
			AEG16-○1	0.1	
RAC43A-RAC530A	 (AEGT150304L)		AEG16-○2	0.2	●
			AEG16-○4	0.4	
			AEG16-○4	0.4	

Please add the grade indication into ○, and add the insert tip material indication at the end off the Code No. e.g. AEG16-F2 (KW10)

★Minimum order quantity : 10pcs.

HSK

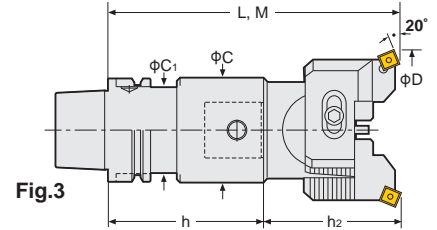
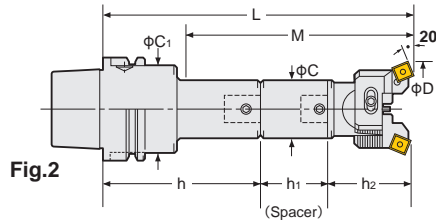
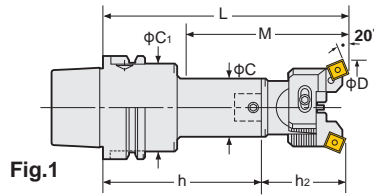
HSK BALANCE-CUT BORING ARBOR (RAC-K)

NIKKEN

Rough Boring—For Through Hole and Multi Sheets

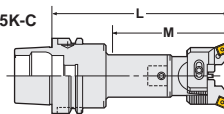


RAC-K



TAPER	Code No.	Boring Range D	Boring Depth M	C	C ₁	Shank Code No.	Spacer Code No.	P.234		Weight (kg)	Fig	
								Head Code No.	Tip No.			
HSK63A	HSK 63A-RAC25-135K	25~32	67	15	24	HSK 63A-Q12- 80	—	12-RAC 25- 55K	SC09	1.7	1	
	-165K		105			-Q12-110						1.8
	-180K		112			-Q12- 80						SP12-12-45
	-RAC32-150K	32~45	77	19	30	-Q16- 95	—	16-RAC 32- 55K	SC09	2.1	1	
	-180K		110			-Q16-125						2.3
	-195K		122			-Q16- 95						SP16-16-45
	-RAC43-150K	43~55	97	40	50	-Q20- 80	—	20-RAC 43- 70K	SC12	2.4	1	
	-180K		130			-Q20-110						2.6
	-210K		157			-Q20- 80						SP20-20-60
	-RAC53-165K	53~70	135	53	53	-Q26- 95	—	26-RAC 53- 70K	SC12	2.2	1	
	-210K		180			-Q26-140						3.0
	-225K		195			-Q26- 95						SP26-26-60
	-RAC70-180K	70~100	180	64	52.4	-Q34- 95	—	34-RAC 70- 85K	SC12	4.5	3	
	-195K		195			-Q34-110						4.9
	-RAC100-195K		100~130			195						83

- ★“C” grade (Coated) inserts are supplied as standard with the head. Please refer P.68 for cutting condition.
- ★Please refer P.243 for base holder, P.86 for spacer and P.69 for head.
- ★For centre through tool coolant type, please add “-C” at the end of Code No. e.g. HSK63A-RAC53-165K-C
- ★For HSK40A or 50A, modular connection system is applied. Please refer P.243 for Base Holder.
- ★When L length is required longer than standard, please specify the boring depth M.



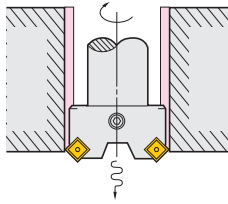
High Pressure Coolant Through Tool

HSK BALANCE-CUT BORING ARBOR (RAC-K)

NIKKEN

Balance cut boring bar executes boring in 2 cartridge inserts absorbing the vibration each other. The faster the feed rate, the better swarf ejection. This is Ideal for rough and medium boring.

Double Cutting Capability



TAPER	Code No.	Boring Range D	Boring Depth M	C	C ₁	Shank Code No.	Spacer Code No.	P.234		Weight (kg)	Fig	
								Head Code No.	Tip No.			
HSK100A	HSK100A-RAC 25-150K	25~32	67	15	24	HSK100A-Q12- 95	—	12-RAC 25- 55K	SC09	3.9	1	
	-180K		105			-Q12-125				4.1		
	-195K		112			-Q12- 95				SP12-12-45	4.0	2
	-RAC 32-180K	32~45	77	31	50	-Q16-125N	—	16-RAC 32- 55K	SC09	4.6	1	
	-210K		110			-Q16-155				4.8		
	-225K		122			-Q16-125N				SP16-16-45	4.8	2
	-RAC 43-180K		97			-Q20-110				20-RAC 43- 70K	SC12	4.9
	-195K	130	-Q20-125	5.0								
	225K	142	-Q20-110	SP20-20-45	5.3	2						
	-240K	157	-Q20-110	SP20-20-60	5.4							
	-RAC 53-210K	53~70	117	53	65	-Q26-140	—	26-RAC 53- 70K	SC12	6.1	1	
	-240K		182			-Q26-170N				6.2		
	-270K		177			-Q26-140				SP26-26-60	6.8	2
	-RAC 70-255K	70~100	202	64	80	-Q34-170	—	34-RAC 70- 85K	SC12	8.7	1	
	-285K		232			-Q34-200				9.1		
	-315K		262			-Q34-170				SP34-34-60	10.1	2
	-RAC100-225K		225			-Q42-125				42-RAC100-100K	SC12	11.7
	-290K	290	-Q42-190	11.7								
	-315K	315	-Q42-125	SP42-42-90	15.1	2						

★“C” grade (Coated) inserts are supplied as standard with the head. P.68 Please refer P.95 for cutting condition.
 ★Please refer P.243 for base holder, P.86 for spacer and P.69 for head.
 ★For centre through tool coolant type, please add “-C” at the end of Code No. e.g. HSK100A-RAC53-210K-C
 ★HSK100A-RAC100-375K, 425K and 475K are also available.

Insert tip for RAC-K

● : best ○ : good

Material	Steel		Stainless Steel		Cast Iron		Aluminium	
	●	○	●	○	○	●	○	○
Applicable Arbor	Dimension	Code No.	Material Nose R	Coated Carbide M	Coated Carbide K	Grade C		
				AC630M	AC410K			
RAC25K, RAC32K		SC09-○4	0.4	●	●			
RAC43K-RAC100K		SC12-○8	0.8	●	●			

Please add the grade indication into ○, and add the insert tip material indication at the end off the Code No. e.g. SC12-C8 (AC630M)

★Minimum order quantity : 10pcs.

HSK

HSK BALANCE-CUT RAC BORING ARBOR for LARGE DIA. **NIKKEN**

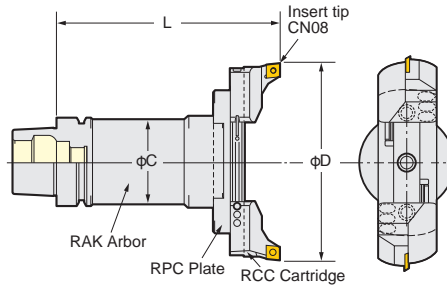
For Roughing

- With the screws for slight adjustment
- Boring Dia. : $\phi 130 \sim \phi 580\text{mm}$



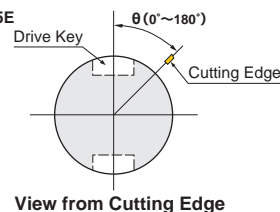
RAC

Boring Dia.: $\phi 130 \sim 580\text{mm}$



TAPE	Code.No	D	L	C	RAK Arbor Code No.	RPC Plate No.	RCC Cartridge No.	Weight (Kg)
		MIN.~MAX.						
HSK 63A	HSK 63A-RAC130-205	130~180	205	61	HSK 63A-RAK-130	RPC-130		6.5
	-RAC180-205	180~230				-180		7.5
HSK100A	HSK100A-RAC130-185	130~180	185	90	HSK100A-RAK-110A	RPC-130	For Heavy Duty Boring of Iron and Cast Iron RCC-130 x2 Insert Tip CN08	9.3
	-235		235		-160A			11.8
	-285		285		-210A			14.5
	-335		335		-260A			17.2
	-385		385		-310A			19.9
	-435		435		-360A			22.6
	-485		485		-410A			25.3
	-RAC180-185		185		-RAK-110A			11.3
	-235	180~230	235		-160A	9.9		
			285		-210A	12.4		
			335		-260A	15.1		
			385		-310A	17.8		
			435		-360A	20.5		
			485		-410A	23.2		
			-RAC230-185		185	-RAK-110A		10.6
			-235		230~280	235		-160A
	285	-210A				15.8		
	335	-260A				18.5		
	385	-310A				21.2		
	435	-360A				23.9		
	485	-410A				26.6		
	-RAC280-185	185				-RAK-110A		11.2
	-235	280~330				235		-160A
			285		-210A	16.4		
			335		-260A	19.1		
			385		-310A	21.8		
			435		-360A	24.5		
			485		-410A	27.2		
-RAC330-210			330~380		RPC-330	17.8		
-RAC380-210			380~430	210	98	HSK100A-RAK330-125	-380	18.6
-RAC430-210	430~448	-430	19.5					
-RAC480-210	480~530	-480	20.4					
-RAC530-210	530~580	-530	21.2					

- ★The Code No. on above table are the boring arbors with RCC-130 cartridge (Insert tip: CN08) the Heavy Duty Boring of Iron and Cast Iron. Please refer P.95 for cutting condition.
- ★Boring arbor with cartridges & insert for Steel, Stainless Steel and Cast Iron (E), for Aluminum (A) and for Through Hole & Multi Sheets (K) are available. Please refer P.236 for cartridges. e.g. HSK100A-RAC130-185E
- ★Please refer P.236 for RAK arbor and RPC plate.
- ★Arbor, plate and cartridges are delivered in separate packages.
- ★Please check the interference of the arbor with your M/C not to occur the interference in the tool magazine.
- ★The location of the cutting edge is same as the drive key for standard. The different location is available, please specify θ . e.g. HSK100A-RAC180-235 (90°)
- ★For centre through tool coolant type, please add“-C”at the end of Code No. e.g. HSK100A-RAC130-185-C



View from Cutting Edge

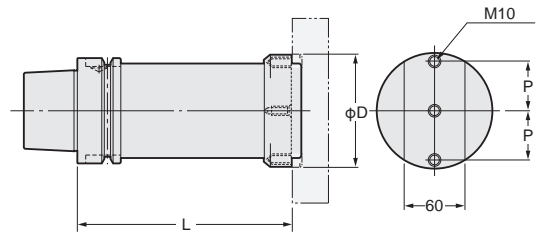


High Pressure Coolant Through Tool

HSK MODULAR TYPE ARBOR



BALANCE CUT RAK BORING ARBOR for LARGE DIA.<RAK Arbor>



RAK

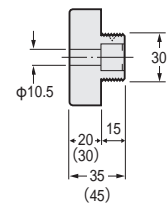
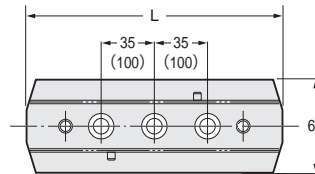
Code No.	Boring Range	L	D	P	Weight (Kg)	Applicable RPC Plate	Hex. Socket bolt
HSK 63A-RAK-130	130~230	130	102	35	4.3	RPC-130, 180	M1035
HSK100A-RAK-110A	130~330	110			6.7	RPC-130, 180, 230, 280	
-RAK-160A		160			9.2		
-RAK-210A		210			11.9		
-RAK-260A		260			14.6		
-RAK-310A		310			17.3		
-RAK-360A		360			20.0		
-RAK-410A		410			22.7		
-RAK330-125	330~580	125	240	100	11.3	RPC-330, 380, 430, 480, 530	M1045

★The location of the cutting edge is same as the drive key for standard. The different location is available, please specify θ. e.g. HSK100A-RAK-160A(90°)

★For centre through tool coolant type, please add“-C”at the end of Code No. e.g. HSK100A-RAK-160A-C 2 set of coolant nozzles are standard accessory.



BALANCE CUT PLATE for LARGE DIA.<RPC Plate>



Dimensions in () are for RPC-330, 380, 430, 480 and 530.

Code No.	Boring Range	L	Weight(Kg)	Code No.	Boring Range	L	Weight(Kg)	Code No.	Boring Range	L	Weight(Kg)
RPC-130	130~180	118	1.4	RPC-330	330~380	316	5.3	RPC-530	530~580	516	8.7
-180	180~230	166	2.0	-380	380~430	366	6.1				
-230	230~280	216	2.7	-430	430~480	416	7.0				
-280	280~330	266	3.3	-480	480~530	466	7.9				

Accessories for Balance-Cut RAC

Steel, Stainless Steel and Cast Iron
RCC-130 (CN08)



Heavy Duty Boring of Iron and Cast Iron
RCC-130E (CC12)



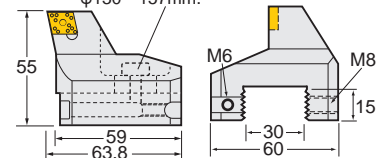
For aluminum
RCC-130A (AEG16)



For Through Hole and Multi Sheets
RCC-130K (SC12)



Cartridge Lock Bolt
Please remove the bolt when using RAC-130 type for φ130~157mm.



Weight : 0.6Kg

Accessories	Insert Tip	Clamp Bolt	Adjust Screw	Adjust Wrench	Wrench for Insert	Set Screw (M8)	L-Wrench for M815 Bolt	Hex Socket Bolt	Applicable RPC Plate
Code No.	*	CSM-70	M540	M3	20S	M815	M4	M625	RPC-130, 180, 230, 280, 330, 380, 430, 480, 530

★*: The insert tip is RCC-130:CN08 (P.64), RCC-130E:CC12 (P.62), RCC-130A:AEG16 (P.66), RCC-130K:SC12 (P.68) Please refer P.95 for cutting condition.

★There are two different types clamping system. One is eccentric system, the other is screw on system. Above parts are for screw on system.

★Code No. RCC-130 indicates a single cartridge. When ordering a pair cartridge, please appoint to us Code No. S.RCC-130.

★The Code No. of the cartridges for 2 stepped balance cut is SRCC-130-0.3

HSK ZMAC BORING ARBOR (ZMAC)



Boring for Finishing



ZMAC

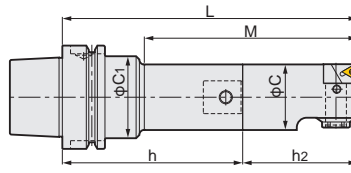


Fig.1

ZMAC16

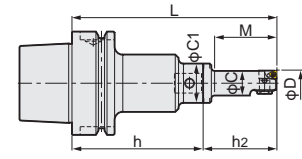


Fig.3

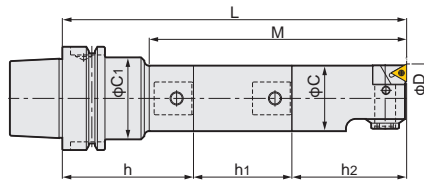


Fig.2

ZMAC100, 140

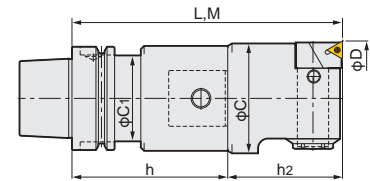
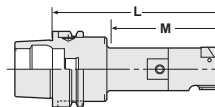


Fig.4

Code No. of the insert tip are shown.

TAPER	Code No.	Boring Range D	Boring Depth M	C	C ₁	Shank Code No.	Extension Spacer Code No.	P.98		Weight (kg)	Fig	
								Head No.	Insert No.			
HSK63A	HSK63A-ZMAC16-125	15.8~20.2	38	15	24	HSK63A-Q12- 80	—	12-ZMAC16- 45	3MP-C,B	1.6	3	
	-135		48					12-ZMAC16- 55				1.6
	-ZMAC20-120	19.8~25.2	45	19	30	-Q 9- 80	—	9-ZMAC20- 40		1.6	1	
	-135		67							-Q 9- 95N		1.6
	-150		75							-Q 9- 80		1.7
	-ZMAC25-120	24.8~32.2	52	24	35	-Q12- 80	—	12-ZMAC25- 40		1.7	1	
	-150		90							-Q12-110		1.8
	-165		97							-Q12- 80		1.8
	-ZMAC32-150	31.8~42.2	77	31	42	-Q16- 95	—	16-ZMAC32- 55		2.2	4MP-C,B	
	-180		110							-Q16-125		2.4
	-195		122							-Q16- 95		2.4
	-ZMAC42-150	41.8~55.2	97	40	50	-Q20- 80	—	20-ZMAC42- 70		2.7	6MP-C,B	
	-180		130							-Q20-110		2.9
	-210		157							-Q20- 80		3.1
	-ZMAC55-165	54.8~70.2	135	53	50	-Q26- 95	—	26-ZMAC55- 70		3.6	1	
	-210		180							-Q26-140		4.3
	-225		195							-Q26- 95		4.3
	-ZMAC70-165	69.8~85.2	165	67	52.4	-Q34- 95	—	34-ZMAC70- 70		5.1	4	
	-180		180							-Q34-110		5.5
	-225		225							-Q34- 95		6.5
-ZMAC85-195	84.8~100.2	195	83	52.4	-Q42- 95	—	42-ZMAC85-100	8.7				

- ★MIN. dial readout : ZMAC25 & smaller is 0.02mm on diameter. ZMAC32 and larger are 0.01mm on diameter.
- ★"C" grade (Coated) insert for Steel, Stainless & Cast Iron is supplied as Standard with the head (Smooth boring & Long tool-life). Please refer for cutting condition. We would recommend "B" grade (CBN) insert for Hardened Steel & High Speed boring of Cast Iron.
- ★Please refer for base holder, for spacer and for head.
- ★For Centre Through Tool Coolant type, please add "C" at the end of Code No. e.g. HSK63A-ZMAC55-165C.
- ★For HSK40A or 50A, modular connection system is applied. Please refer for Base Holder.
- ★When L length is required longer than standard, please specify boring depth M.



Boring Arbor with Extension Spacer



ZMAC for Multi-Stage Boring Bar

Please contact us for the special boring bar.



High Pressure Coolant Through Tool

HSK ZMAC BORING ARBOR (ZMAC)



■ With ZMAC α Boring Head
Please add "AA" at the end of Code No.
e.g. HSK63A-ZMAC42-150AA



Diameter can be adjusted easily and quickly by new handle with wrench.



Unlock

Adjust diameter

Lock

Code No. of the insert tip are shown.

TAPER	Code No.	Boring Range D	Boring Depth M	C	C ₁	Shank Code No.	Extension Spacer Code No.	P.98		Weight (kg)	Fig							
								Head No.	Insert No.									
HSK100A	HSK100A-ZMAC 16-140	15.8~20.2	38	15	24	HSK100A-Q12- 95	—	12-ZMAC 16- 45	3MP-C,B	3.9	3							
	-150		48					12-ZMAC 16- 55		3.9								
	-ZMAC 20-150	19.8~25.2	45	19	40	-Q 9-110	—	9-ZMAC 20- 40	3MP-C,B	4.0	1							
	-165		67							-Q 9-125N		4.0						
	-180		75								SP 9- 9-30	4.1	2					
	-ZMAC 25-135		24.8~32.2							52	24	44		-Q12- 95	—	12-ZMAC 25- 40	3MP-C,B	4.0
	-165	90		-Q12-125	4.0													
	-180	97			SP12-12-45	4.1	2											
	-ZMAC 32-180	31.8~42.2		77	31	50		-Q16-125N	—	16-ZMAC 32- 55			4MP-C,B					4.7
	-210		110	-Q16-155			4.8											
	-225		122				SP16-16-45				4.9	2						
	-ZMAC 42-180		41.8~55.2	97			40				60			-Q20-110	—	20-ZMAC 42- 70	6MP-C,B	5.2
	-195	130		-Q20-125	5.2													
	-225	142			SP20-20-45	5.6		2										
	-240	157		SP20-20-60	5.7													
	-ZMAC 55-210	54.8~70.2		117	53	65		-Q26-140	—	26-ZMAC 55- 70		6MP-C,B	6.7					1
	-240			182									-Q26-170N					
	-270		177	SP26-26-60			8.3				2							
	-ZMAC 70-240		69.8~85.2	187			67						80	-Q34-170	—	34-ZMAC 70- 70	6MP-C,B	9.2
	-270	217		-Q34-200	9.8													
	-300	247			SP34-34-60	10.7		2										
	-ZMAC 85-225	84.8~100.2		187	83	—			-Q42-125	—	42-ZMAC 85-100	6MP-C,B						11.7
	-290		252	-Q42-190			14.2											
	-315		277				SP42-42-90	15.2					2					
	-ZMAC100-225		99.5~140.5	225			95	98						-Q42-125	—	42-ZMAC100-100	6MP-C,B	11.6
	-290	290		-Q42-190	14.3													
	-325	325			-Q42-225A	17.0												
	-375	375		-Q42-275A		19.7												
-425	425	-Q42-325A		22.4														
-ZMAC140-225	139.5~180.5	225		135	98	-Q42-125			—	42-ZMAC140-100	6MP-C,B	13.0	4					
-290		290										-Q42-190						15.7
-325		325																-Q42-225A
-375		375	-Q42-275A				21.1											
-425		425	-Q42-325A				23.8											

★MIN. dial readout : ZMAC25 & smaller is 0.02mm on diameter. ZMAC32 and larger are 0.01mm on diameter.
★When L length is required longer than standard, please specify boring depth M. ★For Centre Through Tool Coolant type, add "C" at the end of Code No. e.g. HSK100A-ZMAC55-210C.
★"C" grade (Coated) insert for Steel, Stainless&Cast Iron is supplied as Standard with the head (Smooth boring & Long tool-life). P.98
We would recommend "B" grade (CBN) insert for Hardened Steel & High Speed boring of Cast Iron. Please refer P.96 for cutting condition.
★Please refer P.243 for base holder, P.86 for spacer and P.77, P.78 for head.

HSK ZMAC BORING ARBOR (ZMAC-R)



Boring for Semi-Finishing—ZMAC-R



ZMAC-R

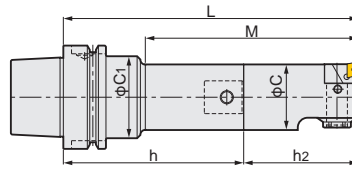


Fig.1

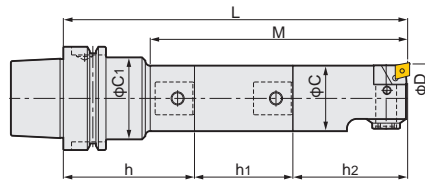


Fig.2

ZMAC100, 140

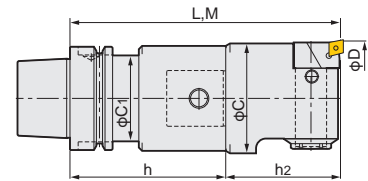







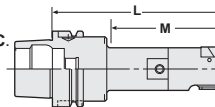


Fig.3

Code No. of the insert tip  are shown.

TAPER	Code No.	Boring Range D	Boring Depth M	C	C ₁	Shank Code No.	Extension Spacer Code No.	P.240		Weight (kg)	Fig	
								Head No.	Insert No.			
HSK63A	HSK63A-ZMAC32R-150	31.8~42.2	77	31	42	HSK63A-Q16- 95	—	16-ZMAC32R- 55	CC06-C	2.2	1	
	-180		110			-Q16-125						2.4
	-195		122			-Q16- 95						2.4
		ZMAC42R-150	41.8~55.2	97	40	50	-Q20- 80	—	20-ZMAC42R- 70	CC06-C	2.7	1
	-180	130		-Q20-110			2.9					
	-210	157		-Q20- 80			3.1					
		ZMAC55R-165	54.8~70.2	135	53	50	-Q26- 95	—	26-ZMAC55R- 70	CC06-C	3.6	1
	-210	180		-Q26-140			4.3					
	-225	195		-Q26- 95			4.3					
		ZMAC70R-165	69.8~85.2	165	67	52.4	-Q34- 95	—	34-ZMAC70R- 70	CC08-C	5.1	4
	-180	180		-Q34-110			5.5					
	-225	225		-Q34- 95			6.5					
	ZMAC85R-195	84.8~100.2	195	83	52.4	-Q42- 95	—	42-ZMAC85R-100		8.7		

- ★MIN. dial readout : ZMAC25 & smaller is 0.02mm on diameter. ZMAC32 and larger are 0.01mm on diameter.
- ★"C" grade (Coated) insert for Steel, Stainless & Cast Iron is supplied as Standard with the head (Smooth boring & Long tool-life).  P.76 Please refer  P.96 for cutting condition. We would recommend "B" grade (CBN) insert for Hardened Steel & High Speed boring of Cast Iron.
- ★Please refer  P.243 for base holder,  P.86 for spacer and  P.77, P.78 for head.
- ★For Centre Through Tool Coolant type, please add "C" at the end of Code No. e.g. HSK63A-ZMAC55R-165C.
- ★For HSK40A or 50A, modular connection system is applied. Please refer  P.243 for Base Holder.
- ★When L length is required longer than standard, please specify boring depth M.



High Pressure Coolant Through Tool

Boring Arbor with Extension Spacer



ZMAC for Multi-Stage Boring Bar

Please contact us for the special boring bar.



HSK ZMAC BORING ARBOR (ZMAC-R)



Insert Tip for ZMAC-R

●:best ○:good

Material	Steel		●	○	
	Stainless Steel		●	○	
	Cast Iron		○	●	
Material	Aluminium				
	High Speed finish for Cast Iron				
	Hardened Steel				
	High Speed finish for Aluminium				
		Coated Carbide M	Coated Carbide K		
		Grade	C		
		Material	AC630M	AC410K	
Applicable Arbor	Dimension	Code No.	Nose R	AC630M	AC410K
ZMAC32R, ZMAC42R, ZMAC55R		CC06-○4	0.4	●	●
		CC06-○8	0.8	●	●
		CC08-○4	0.4	●	●
ZMAC70R, ZMAC85R		CC08-○4	0.4	●	●
		CC08-○8	0.8	●	●
		CC12-○4	0.4	●	●
ZMAC100R, ZMAC140R		CC12-○8	0.8	●	●

Please add the grade indication into ○, and add the insert tip material indication at the end off the Code No. e.g. CC12-C8(AC630M)

There is the CBN insert tip which both corners can be used. Please refer P.98 for ISO code of the insert tip.

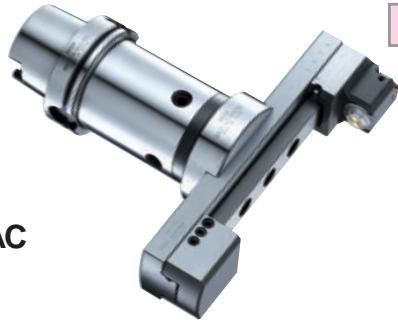


Code No. of the insert tip are shown.

TAPER	Code No.	Boring Range D	Boring Depth M	C	C ₁	Shank Code No.	Extension Spacer Code No.	P.240		Weight (kg)	Fig	
								Head No.	Insert No.			
HSK100A	HSK100A-ZMAC 32R-180	31.8~42.2	77	31	50	HSK100A-Q16-125N	—	16-ZMAC 32R- 55	CC06-C	4.7	1	
	-210		110			-Q16-155						4.8
	-225		122			-Q16-125N						4.9
	-ZMAC 42R-180	41.8~55.2	97	40	60	-Q20-110	—	20-ZMAC 42R- 70	CC06-C	5.2	1	
	-195		130			-Q20-125						5.2
	-225		142			-Q20-110						5.6
	-240		157			-Q20-110						5.7
	-ZMAC 55R-210	54.8~70.2	117	53	65	-Q26-140	—	26-ZMAC 55R- 70	CC06-C	6.7	1	
	-240		182			-Q26-170N						6.8
	-270		177			-Q26-140						8.3
	-ZMAC 70R-240	69.8~85.2	187	67	80	-Q34-170	—	34-ZMAC 70R- 70	CC08-C	9.2	1	
	-270		217			-Q34-200						9.8
	-300		247			-Q34-170						10.7
	-ZMAC 85R-225	84.8~100.2	187	83	—	-Q42-125	—	42-ZMAC 85R-100	CC08-C	11.7	1	
	-290		252			-Q42-190						14.2
	-315		277			-Q42-125						15.2
	-ZMAC100R-225	99.5~140.5	225	95	83	-Q42-125	—	42-ZMAC100R-100	CC12-C	11.6	4	
	-290		290			-Q42-190						14.3
	-325		325			-Q42-225A						17.0
	-375		375			-Q42-275A						19.7
	-425		425			-Q42-325A						22.4
	-ZMAC140R-225	139.5~180.5	225	135	83	-Q42-125	—	42-ZMAC140R-100	CC12-C	13.0	4	
	-290		290			-Q42-190						15.7
	-325		325			-Q42-225A						18.4
-375	375		-Q42-275A			21.1						
-425	425		-Q42-325A			23.8						

★MIN. dial readout : ZMAC25 & smaller is 0.02mm on diameter. ZMAC32 and larger are 0.01mm on diameter.
 ★When L length is required longer than standard, please specify boring depth M. ★For Centre Through Tool Coolant type, add "C" at the end of Code No. e.g. HSK100A-ZMAC55R-210C.
 ★"C" grade (Coated) insert for Steel, Stainless&Cast Iron is supplied as Standard with the head (Smooth boring & Long tool-life). P.76
 We would recommend "B" grade (CBN) insert for Hardened Steel & High Speed boring of Cast Iron. Please refer P.96 for cutting condition.
 ★Please refer P.243 for base holder, P.86 for spacer and P.77, P.78 for head.

HSK BALANCE-CUT BAC BORING ARBOR for LARGE DIA. **NIKKEN**

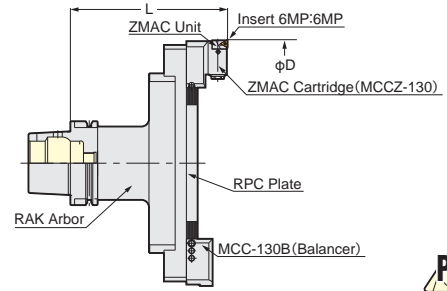


BAC

For Finishing

■ MIN. dial readout on dia. : 0.01mm

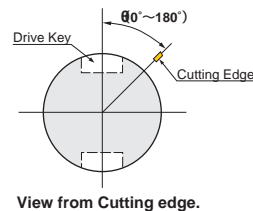
■ Boring Dia : $\phi 130 \sim \phi 595\text{mm}$



Boring Dia: $\phi 130 \sim 595\text{mm}$

TAPER	Code.No	D		L	C	RAK Arbor Code No.	PPC Plate No	Cartridge (Balancer)	Weight (Kg)
		MIN.	MAX.						
HSK 63A	HSK 63A-BAC130-205	130	195	205	61	HSK 63A-RAK-130	RPC-130		6.5
	-BAC180-205	180	245						7.5
HSK100A	HSK100A-BAC130-185	130	195	185	90	HSK100A-RAK-110A	RPC-130	MCCZ-130 (MCC-130B) Insert 6MP	9.5
	-235			235		-160A			12.0
	-285			285		-210A			14.7
	-335			335		-260A			17.3
	-385			385		-310A			20.1
	-435			435		-360A			22.8
	-485			485		-410A			25.5
	-BAC180-185			185		-RAK-110A			10.1
	-235	235	-160A	12.6					
	-285	285	-210A	15.3					
	-335	335	-260A	18.0					
	-385	385	-310A	20.7					
	-435	435	-360A	23.3					
	-485	485	-410A	26.1					
	-BAC230-185	185	-RAK-110A	10.8					
	-235	235	-160A	13.3					
	-285	285	-210A	16.0					
	-335	335	-260A	18.7					
	-385	385	-310A	21.3					
	-435	435	-360A	24.1					
	-485	485	-410A	26.8					
	-BAC280-185	185	-RAK-110A	11.4					
	-235	235	-160A	13.9					
	-285	285	-210A	16.6					
	-335	335	-260A	19.3					
	-385	385	-310A	22.0					
	-435	435	-360A	24.7					
	-485	485	-410A	27.4					
	-BAC330-210	330	395	210	98	HSK100A-RAK330-125	RPC-330		18.0
	-BAC380-210	380	445				-380		18.8
	-BAC430-210	430	495				-430		19.7
	-BAC480-210	480	545				-480		20.6
-BAC530-210	530	595	-530				21.4		

- ★ "C" grade (Coated) Inserts are supplied as standard. Please refer for cutting condition.
- ★ Unit "M5HZ-55" is provided as standard, please refer for Arbor (RAK) and Plate (RPC).
- ★ Arbor, Plate and Cartridge are delivered in separate packages.
- ★ When ordering, please let us know machine maker and model no. to avoid the interference with tool magazine of ATC.
- ★ The location of cutting edge is same as drive key in standard.
- ★ The different location is available, please specify θ in Code No. e.g. HSK100A-BAC180-235 (90°)
- ★ For centre through tool coolant type, please add "-C" at the end of Code No. e.g. HSK100A-BAC130-185-C



View from Cutting edge.



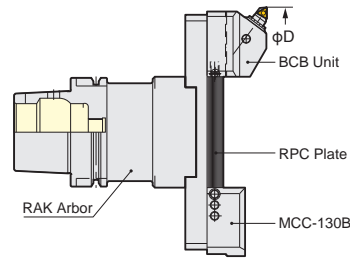
High Pressure Coolant Through Tool

HSK BALANCE-CUT BCB BORING ARBOR for LARGE DIA. **NIKKEN**

For Roughing / Finishing



BCB



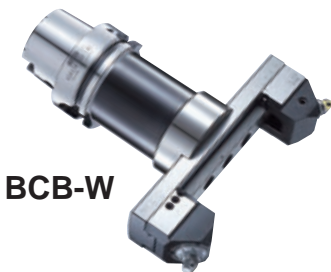
Boring Dia: $\phi 130 \sim 595\text{mm}$

TAPER	Code.No	D		L	C	RAK Arbor Code No.	PPC Plante No	Cartridge (Balancer)	Weight (Kg)							
		MIN.	MAX.													
HSK 63A	HSK 63A-BCB130-215	130	195	215	61	HSK 63A-RAK-130	RPC-130		6.9							
	-BCB180-215	180	245						7.9							
	HSK100A	HSK100A-BCB130-195	130	195	195	90	HSK100A-RAK-110A	RPC-130	BCB-130 (MCC-130B) Insert 10MP	9.8						
		-245								245	12.3					
		-295								295	15.0					
		-345								345	17.7					
		-395								395	20.4					
		-445								445	23.1					
		-495								495	25.8					
		-BCB180-195								180	195	195	90	HSK100A-RAK-110A	RPC-180	10.2
-245		245														12.9
-295		295														15.6
-345		345	18.3													
-395		395	21.0													
-445		445	23.7													
-495		495	26.4													
-BCB230-195		230	195	195	90	HSK100A-RAK-110A	RPC-230	10.9								
-245								245	13.6							
-295								295	16.3							
-345								345	19.0							
-395								395	21.7							
-445								445	24.4							
-495	495							27.1								
-BCB280-195	280	195	195	90	HSK100A-RAK-110A	RPC-280	11.5									
-245							245	14.2								
-295							295	16.9								
-345							345	19.6								
-395							395	22.3								
-445							445	25.0								
-495							495	27.7								
-BCB330-220	330	395	220	98	HSK100A-RAK330-125	RPC-330	18.1									
-BCB380-220							380	445	-380	18.9						
-BCB430-220							430	495	-430	19.8						
-BCB480-220							480	545	-480	20.7						
-BCB530-220							530	595	-530	21.5						

★10MP-T (Cermet) is supplied as standard. P.98 Please refer P.96 for cutting condition.
★MIN. dial readout on dia.: 0.02mm, Sub scale: 0.002mm

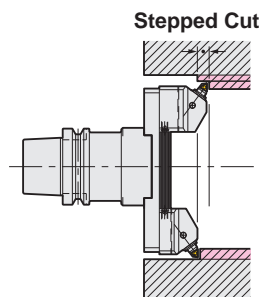
Up to $\phi 800$ is also available. Please contact with us.

Double Cut Style BCB Boring Bar



BCB-W

- ★Double cut style can be done with both side of BCB-130 cartridges. Please add "W" at the end of Code No. e.g. HSK100A-BCB130W-195
- True balance cut can be done to adjust the height by micro adjustment first and then to adjust the diameter by adjust screw.
- Stepped cut can be done to change the height of the cartridges.



HSK BASE HOLDER for MODULAR TYPE



Q

Fig.1

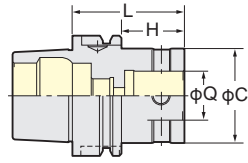


Fig.2

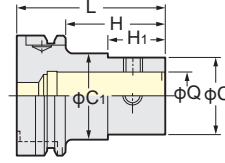
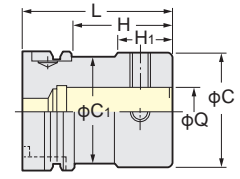
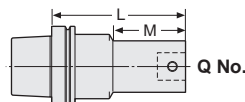


Fig.3



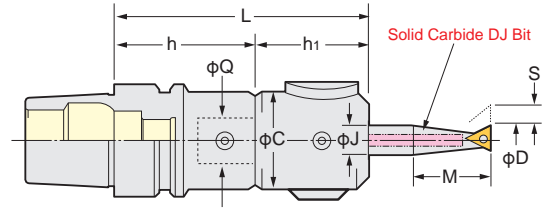
TAPER	Code No.	Q	L	C	C1	H	H1	Coupling Bolt No.	Fig.	Weight(kg)	
HSK 40A	HSK 40A-Q26- 75	26	75	50	33.6	55	40	B26N	3	0.8	
HSK 50A	HSK 50A-Q26- 75	26	75	50	41.6	48	33	B26N	3	1.1	
HSK 63A	HSK 63A-Q 9- 80	9	80	19	30	49	5	B19	2	0.7	
	- 95N		95			64	27			0.7	
	-Q12- 80	12	80	24	35	49	12	B12	2	0.8	
	-110		110			79	50			0.8	
	-Q16- 95	16	95	31	42	64	22	B16	2	1.0	
	-125		125			94	55			1.1	
	-Q20- 80	20	80	40	50	53	27	B20	2	1.4	
	-110		110			83	60			1.3	
	-Q26- 60	26	60	50	—	33	—	B26N	1	1.0	
	- 95		95			68				—	1.5
	-140		140			113				—	2.3
	-Q34- 95	34	95	64	52.4	68	53	B34	3	2.0	
	-110		110			83	68			2.4	
	-Q42- 95	42	95	83	52.4	68	35	B42	3	2.5	
HSK100A	HSK100A-Q 9-110	9	110	19	40	76	5	B19	2	2.3	
	-125N		125			91	27			2.3	
	-Q12- 95	12	95	24	44	61	12	B12	2	2.3	
	-125		125			91	50			2.3	
	-Q16-125N	16	125	31	50	91	22	B16	2	2.8	
	-155		155			121	55			2.9	
	-Q20-110	20	110	40	60	76	27	B20	2	3.0	
	-125		125			91	60			2.9	
	-Q26- 65	26	65	50	65	33	—	B26N	1	2.4	
	-140		140			106	45		2	4.5	
	-170N		170			136	110		4.6		
	-Q34-140	34	140	64	80	106	—	B34	1	4.4	
	-170		170			138	117		2	5.3	
	-200		200			168	147		5.9		
	-Q42-125	42	125	83	—	95	—	B42	1	5.3	
	-190		190			160				7.9	
	-Q42-225A	42	225	83	—	—	—	B42	1	11.7	
	-275A		275							14.4	
-325A	325		17.1								
-375A	375		19.8								

- ★φC of Q26 base holder has been increased from 45mm to 50mm due to improvement of its rigidity.
- ★All base holders have a centre through-tool coolant hole.
- ★The Coupling screw & wrench are supplied as standard.
- ★When L length is required longer than standard, please specify the boring depth M.



Q No.

HSK DJ BORING BAR



DJ

High Pressure Coolant Through Tool is available.

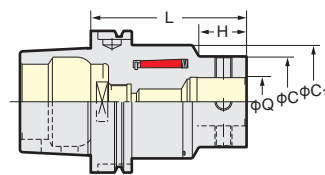


TAPER	Code No.	Boring Range	Boring Depth	L	C	Bit Hole Size	Shank Code No.	Head Code No.	Bit Stroke	DJ Bit Code No.
		D	M			J				
HSK 63A	HSK 63A-DJ3- 96	3~28	14~ 80	96	45	10	HSK 63A-Q26- 60	Q26-DJ3-36	5.2	J10
	-131			131						
	-DJ8-104AN	3~50	14~130	104	59	16	HSK 63A-Q26- 60	-DJ8-44AN	6.0	J16
	-139AN			139						
HSK100A	HSK100A -DJ3-101	3~28	14~ 80	101	45	10	HSK100A-Q26- 65	Q26-DJ3-36	5.2	J10
	-206			206						
	-DJ8-109AN	3~50	14~130	109	59	16	HSK100A-Q26- 65	-DJ8-44AN	6.0	J16
	-214AN			214						

- ★MIN. dial readout on dia.: 0.01mm, Sub scale: 0.005mm, 0.8mm/rev.
- ★Each boxed set of DJ3 and DJ8 Boring Bars include 4 pcs of DJ Boring Bits as standard.
- ★Bits included to HSK63A-DJ8-94A : J16-8-40, J16-18-80, J16-28-85, J16-38-85
- ★Bits included to HSK63A-DJ8-94AN : J16-8-40, J16-18-60, J16-28-65, J16-38-65
- ★DJ Boring Bar without Boring Bits is also available. Please add"-BD" at the end of Code No. e.g. HSK63A-DJ3-96-BD
- ★Shank and DJ Head(including Boring Bits)are delivered in separate packages.
- ★Please refer P.84 for Boring Bits. Please refer P.97 for cutting condition.

MAJOR DREAM HOLDER

HSK BASE HOLDER for MODULAR TYPE



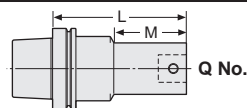
MDQ

Photo shows with spacer and ZMAC head.

PAT.

TAPER	Code No.	Q	L	C	C1	H	Weight(kg)	ZMAC Boring Range
HSK 50A	HSK 50A-MDQ26- 95	26	95	50	50	95.0	1.2	16~70
HSK 63A	HSK 63A-MDQ26-100	26	100	50	52.4	30.0	1.5	16~70
HSK100A	HSK100A-MDQ26-135	26	135	50	80	18.0	5.2	16~70
	-MDQ34-140	34	140	64		27.5	5.3	16~85
	-MDQ42-150	42	150	83		121	6.1	16~180

- ★All base holders have a centre through coolant hole.
- ★The coupling bolt and wrench are supplied as standard.
- ★When L length is required longer than standard, please specify the boring depth M and Q No.

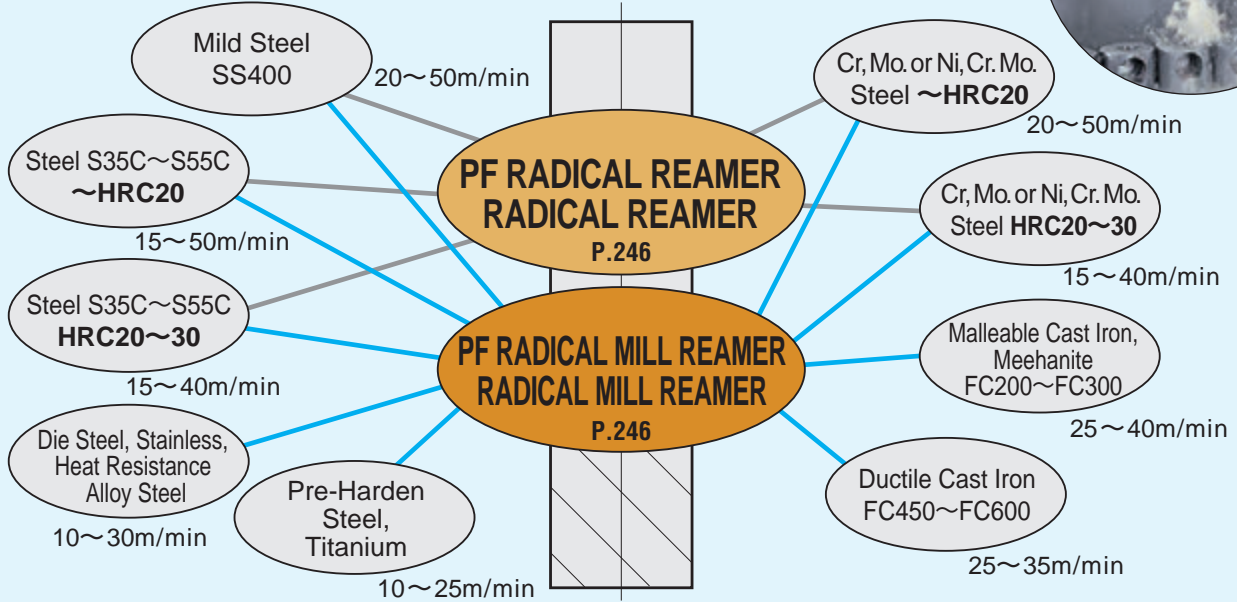


HSK

Wide Product Range to meet Any Material Requirements
Long Life • High Finishing Accuracy on Tough Materials

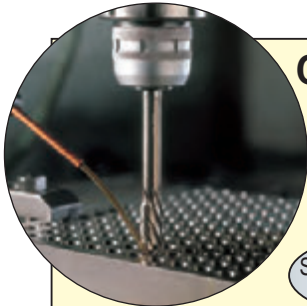


Cutting Speed on Each Material for Soluble Coolant Use

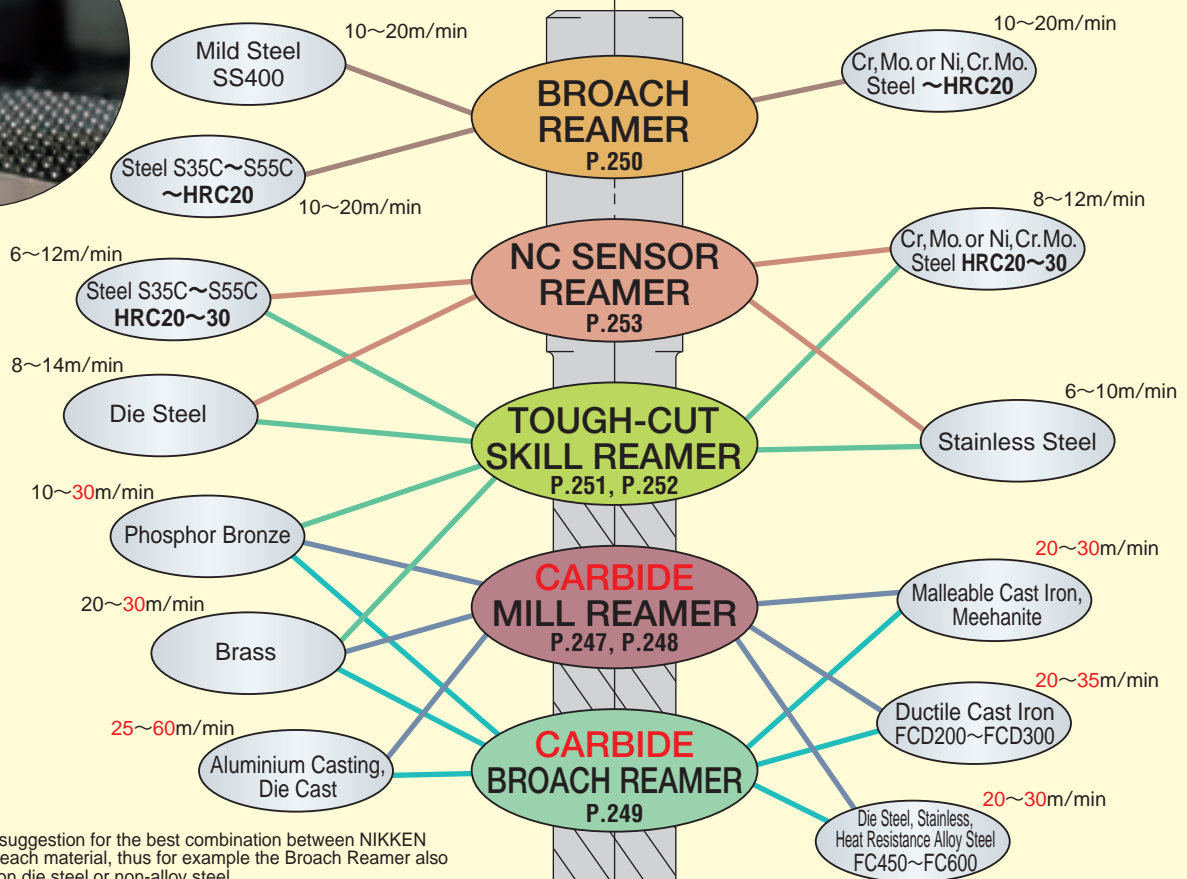


- Radical reamer has been developed for reaming with soluble coolant, thus when the standard radical reamer is used with oil base coolant the finished diameter might be larger than expected. Please contact with us for further details.
- Please use **Carbide** Mill Reamer or **Carbide** Broach Reamer (Non-Coated) for **Aluminium**.

REAMER•DRILL



Cutting Speed on Each Material for Oil Base Coolant Use



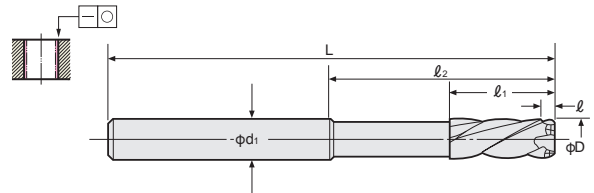
This is just a suggestion for the best combination between NIKKEN reamers and each material, thus for example the Broach Reamer also can be used on die steel or non-alloy steel. The further improved combination can be selected dependent on the machine, type of coolant and other cutting condition.

(The above cutting speed in red shows the ones achieved with carbide reamer.)

NIKKEN CARBIDE PF RADICAL REAMER SERIES



PF Radical Mill Reamer (Straight Shank) Through Hole

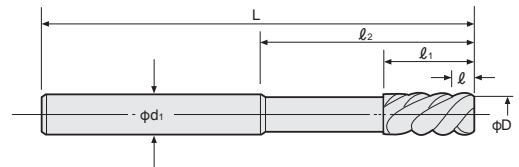


φ3~φ14 with every 0.5mm increment is standard. φ15~φ30 with every 1mm increment is semi-standard.

Code No.	D _{H7}	L	φ _{d1h7}	ℓ	ℓ ₁	ℓ ₂	Removal φ	Feed mm/rev
RMSS- 3.0	3.0	60	3	4.0	16	35	0.1~0.3	0.1~0.15
- 4.0	4.0	60	4	4.8	18	35	0.1~0.3	0.1~0.15
- 5.0	5.0	70	5	4.8	22	40	0.1~0.7	0.1~0.15
- 6.0	6.0	85	6	5.4	25	50	0.15~0.7	0.12~0.2
- 7.0	7.0	90	8	6.0	25	50	0.15~0.7	0.2~0.3
- 8.0	8.0	100	8	6.6	25	60	0.15~0.7	0.2~0.3
- 9.0	9.0	105	10	7.0	25	60	0.15~0.7	0.2~0.3
-10.0	10.0	110	10	7.2	29	60	0.15~0.7	0.2~0.3
PF-RMSS-11.0	11.0	115	12	7.9	22	65	0.15~0.7	0.2~0.3
-12.0	12.0	125	12	7.9	22	70	0.15~0.7	0.2~0.3
-13.0	13.0	130	12	8.2	22	75	0.15~0.7	0.2~0.3
-14.0	14.0	130	16	9.0	22	75	0.15~0.7	0.2~0.3
-15.0	15.0	140	16	9.0	22	80	0.15~0.7	0.2~0.3
-16.0	16.0	150	16	9.4	24	90	0.15~0.7	0.2~0.3
-18.0	18.0	155	20	9.4	24	90	0.2~0.7	0.2~0.3
-20.0	20.0	160	20	9.8	24	95	0.2~0.7	0.2~0.3
-21.0	21.0	170	20	10.3	24	105	0.2~0.8	0.2~0.3
-22.0	22.0	170	20	10.8	28	105	0.2~0.8	0.2~0.3
-23.0	23.0	180	25	10.8	28	110	0.2~0.8	0.2~0.3
-24.0	24.0	180	25	10.8	28	110	0.2~0.8	0.2~0.3
-25.0	25.0	190	25	11.3	28	120	0.2~0.8	0.2~0.3
-26.0	26.0	190	25	11.3	28	120	0.2~0.8	0.2~0.3
-27.0	27.0	190	25	11.3	28	120	0.2~0.8	0.2~0.3
-28.0	28.0	200	32	11.6	34	120	0.2~0.8	0.3~0.4
-29.0	29.0	200	32	11.6	34	120	0.2~0.8	0.3~0.4
-30.0	30.0	200	32	11.6	34	120	0.2~0.8	0.3~0.4

- ★The dimension ℓ means the taper length from the top end to the front end reaming diameter φ_{d1}.
- ★The reamer with 'PF-' at the front of the Code No. is Press Fit type, and without this is Carbide Solid type.
- ★We would recommend you to use the NIKKEN reamer with NIKKEN Milling Chuck or Slim Chuck.

PF Radical Reamer (Straight Shank) Through Hole



φ3~φ14 with every 0.5mm increment is standard. φ15~φ30 with every 1mm increment is semi-standard.

Code No.	D _{H7}	L	φ _{d1h7}	ℓ	ℓ ₁	ℓ ₂	Removal φ	Feed mm/rev
RDSS- 3.0	3.0	60	3	4.6	16	35	0.1~0.2	0.1~0.15
- 4.0	4.0	60	4	4.6	18	35	0.1~0.2	0.1~0.15
- 5.0	5.0	70	5	5.7	22	40	0.15~0.2	0.1~0.15
- 6.0	6.0	85	6	5.7	25	50	0.15~0.2	0.12~0.2
- 7.0	7.0	90	8	7.0	25	50	0.2~0.3	0.2~0.3
- 8.0	8.0	100	8	7.0	25	60	0.2~0.3	0.2~0.3
- 9.0	9.0	105	10	7.0	25	60	0.2~0.3	0.2~0.3
-10.0	10.0	110	10	7.0	29	60	0.2~0.3	0.2~0.3
PF-RDSS-11.0	11.0	115	12	7.0	22	65	0.2~0.3	0.2~0.3
-12.0	12.0	125	12	7.0	22	70	0.2~0.3	0.2~0.3
-13.0	13.0	130	12	7.0	22	75	0.2~0.3	0.2~0.3
-14.0	14.0	130	16	7.0	22	75	0.2~0.3	0.2~0.3
-15.0	15.0	140	16	7.0	22	80	0.2~0.3	0.2~0.3
-16.0	16.0	150	16	7.0	24	90	0.2~0.3	0.2~0.3
-18.0	18.0	155	20	7.0	24	90	0.2~0.3	0.2~0.3
-20.0	20.0	160	20	7.0	24	95	0.2~0.3	0.2~0.3
-21.0	21.0	170	20	8.0	24	105	0.3~0.5	0.2~0.3
-22.0	22.0	170	20	8.0	28	105	0.3~0.5	0.2~0.3
-23.0	23.0	180	25	8.0	28	110	0.3~0.5	0.2~0.3
-24.0	24.0	180	25	8.0	28	110	0.3~0.5	0.2~0.3
-25.0	25.0	190	25	8.0	28	120	0.3~0.5	0.2~0.3
-26.0	26.0	190	25	8.0	28	120	0.3~0.5	0.2~0.3
-27.0	27.0	190	25	8.0	28	120	0.3~0.5	0.2~0.3
-28.0	28.0	200	32	8.0	34	120	0.3~0.5	0.3~0.4
-29.0	29.0	200	32	8.0	34	120	0.3~0.5	0.3~0.4
-30.0	30.0	200	32	8.0	34	120	0.3~0.5	0.3~0.4

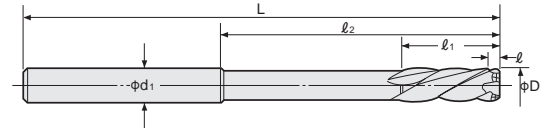
- ★The dimension ℓ means the taper length from the top end to the front end reaming diameter φ_{d1}.
- ★The reamer with 'PF-' at the front of the Code No. is Press Fit type, and without this is Carbide Solid type.
- ★We would recommend you to use the NIKKEN reamer with NIKKEN Milling Chuck or Slim Chuck.

NIKKEN CARBIDE MILL REAMER

NIKKEN

HMS (Straight Shank)

Through Hole



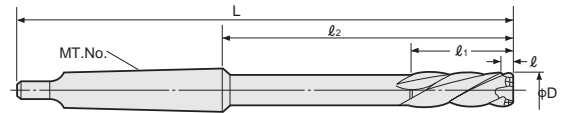
φ3, φ4, φ5~φ14 with every 0.5mm increment is standard. φ15~φ30 with every 0.5mm incremental is semi-standard.

Code No.	D _{H7}	L	φd _{1h7}	ℓ	ℓ ₁	ℓ ₂	Removal φ	Feed mm/rev
HMS- 3.0	3.0	60	3	4.0	16	35	0.1~0.3	0.1~0.3
- 4.0	4.0	60	4	4.8	18	35	0.1~0.3	0.1~0.3
- 5.0	5.0	75	5	4.8	22	45	0.1~0.7	0.15~0.3
- 6.0	6.0	100	6	5.4	25	65	0.15~0.7	0.15~0.3
- 7.0	7.0	110	8	6.0	25	70	0.15~0.7	0.15~0.3
- 8.0	8.0	125	8	6.6	25	85	0.15~0.9	0.15~0.3
- 9.0	9.0	135	10	7.0	25	90	0.15~0.9	0.15~0.3
-10.0	10.0	150	10	7.2	29	100	0.15~0.9	0.15~0.3
-11.0	11.0	155	12	7.9	29	105	0.15~0.9	0.15~0.3
-12.0	12.0	160	12	7.9	29	105	0.15~1.0	0.15~0.3
-13.0	13.0	165	12	8.2	29	110	0.15~1.0	0.15~0.3
-14.0	14.0	170	16	9.0	29	115	0.15~1.0	0.15~0.3
-15.0	15.0	180	16	9.0	29	120	0.15~1.0	0.15~0.3
-16.0	16.0	185	16	9.4	30	125	0.15~1.0	0.15~0.3
-17.0	17.0	185	16	9.4	30	125	0.15~1.0	0.2~0.5
-18.0	18.0	195	20	9.4	30	130	0.2~1.5	0.2~0.5
-19.0	19.0	195	20	9.4	30	130	0.2~1.5	0.2~0.5
-20.0	20.0	205	20	9.8	30	140	0.2~1.5	0.2~0.5
-22.0	22.0	215	20	10.8	33.5	150	0.2~1.5	0.2~0.5
-24.0	24.0	230	25	10.8	33.5	160	0.2~1.8	0.2~0.5
-25.0	25.0	230	25	11.3	33.5	160	0.2~1.8	0.2~0.5
-30.0	30.0	240	32	11.6	39	160	0.2~1.8	0.25~0.6

★The dimension ℓ means the taper length from the top end to the front end reaming diameter φD.
★We would recommend you to use the NIKKEN reamer with NIKKEN Milling Chuck or Slim Chuck.

HMM (Morse Taper Shank)

Through Hole



φ6~φ50 with every 0.5mm increment is standard.

MIN. Reamer Dia:φ3mm

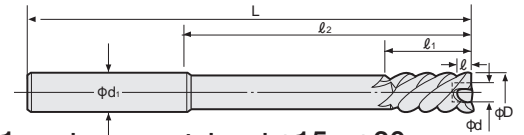
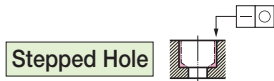
Code No.	D _{H7}	L	MT No.	ℓ	ℓ ₁	ℓ ₂	Removal φ	Feed mm/rev
HMM- 6.0	6.0	130	1	5.4	25	64.5	0.15~0.7	0.15~0.3
- 7.0	7.0	140	1	6.0	25	74.5	0.15~0.7	0.15~0.3
- 8.0	8.0	150	1	6.6	25	84.5	0.15~0.9	0.15~0.3
- 9.0	9.0	165	1	7.0	25	99.5	0.15~0.9	0.15~0.3
-10.0	10.0	165	1	7.2	29	99.5	0.15~0.9	0.15~0.3
-11.0	11.0	170	1	7.9	29	104.5	0.15~0.9	0.15~0.3
-12.0	12.0	175	1	7.9	29	109.5	0.15~1.0	0.15~0.3
-13.0	13.0	180	1	8.2	29	114.5	0.15~1.0	0.15~0.3
-14.0	14.0	180	1	9.0	29	114.5	0.15~1.0	0.15~0.3
-15.0	15.0	200	2	9.0	29	120	0.15~1.0	0.15~0.3
-16.0	16.0	205	2	9.4	30	125	0.15~1.0	0.15~0.3
-17.0	17.0	205	2	9.4	30	125	0.15~1.0	0.2~0.5
-18.0	18.0	210	2	9.4	30	130	0.2~1.5	0.2~0.5
-19.0	19.0	210	2	9.4	30	130	0.2~1.5	0.2~0.5
-20.0	20.0	220	2	9.8	30	140	0.2~1.5	0.2~0.5
-22.0	22.0	230	2	10.8	33.5	150	0.2~1.5	0.2~0.5
-24.0	24.0	250	3	10.8	33.5	151	0.2~1.8	0.2~0.5
-26.0	26.0	255	3	11.3	33.5	156	0.2~1.8	0.2~0.5
-28.0	28.0	260	3	11.6	39	161	0.2~1.8	0.25~0.6
-30.0	30.0	260	3	11.6	39	161	0.2~1.8	0.25~0.6
-40.0	40.0	330	4	12.1	46	206	0.2~2.0	0.25~0.6
-50.0	50.0	385	4	13.5	56	261	0.2~2.2	0.4~0.7

★The dimension ℓ means the taper length from the top end to the front end reaming diameter φD.
★MT shank size for reamer diameter: ~φ14mm: MT1, φ15~23mm: MT2, φ24~32mm: MT3, φ33~62mm: MT4, φ63mm~: MT5.

NIKKEN CARBIDE MILL REAMER



FMS (Straight Shank)

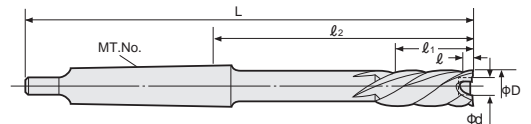
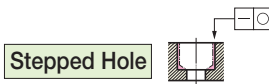


φ8~φ14 with every 1mm increment is standard. φ4~φ7 with every 1mm incremental and φ15~φ30 with every 1mm incremental is semi-standard.

Code No.	D _{H7}	L	φd _{H7}	ℓ	d	ℓ ₁	ℓ ₂	Removal φ	Feed mm/rev
FMS- 4.0	4.0	60	4	0.6	2.0	18	35	0.1~0.3	0.07~0.2
- 5.0	5.0	75	5	0.6	2.5	22	45	0.1~0.3	0.07~0.2
- 6.0	6.0	100	6	0.6	3.0	25	65	0.1~0.5	0.1~0.3
- 7.0	7.0	110	8	0.6	3.5	25	70	0.1~0.5	0.1~0.3
- 8.0	8.0	125	8	0.6	4.0	25	85	0.1~0.6	0.1~0.3
- 9.0	9.0	135	10	0.6	4.5	25	90	0.1~0.6	0.1~0.3
-10.0	10.0	150	10	0.6	5.0	29	100	0.1~0.6	0.1~0.3
-11.0	11.0	155	12	0.6	5.0	29	105	0.1~0.6	0.1~0.3
-12.0	12.0	160	12	0.6	6.0	29	105	0.1~0.8	0.1~0.3
-13.0	13.0	165	12	0.6	6.0	29	110	0.1~0.8	0.1~0.3
-14.0	14.0	170	16	0.6	7.0	29	115	0.1~0.8	0.1~0.3
-15.0	15.0	180	16	0.6	7.0	29	120	0.1~1.0	0.1~0.3
-16.0	16.0	185	16	0.6	7.0	30	125	0.1~1.0	0.1~0.3
-17.0	17.0	185	16	0.6	8.0	30	125	0.1~1.0	0.1~0.3
-18.0	18.0	195	20	0.6	9.0	30	130	0.1~1.0	0.1~0.3
-19.0	19.0	195	20	0.6	9.0	30	130	0.1~1.0	0.1~0.3
-20.0	20.0	205	20	0.6	10.0	30	140	0.1~1.5	0.1~0.3
-22.0	22.0	215	20	0.6	11.0	33.5	150	0.1~1.5	0.1~0.3
-24.0	24.0	230	25	0.6	12.0	33.5	160	0.1~1.8	0.1~0.3
-26.0	26.0	230	25	0.6	14.0	33.5	160	0.1~1.8	0.15~0.4
-28.0	28.0	240	32	0.6	15.0	39	160	0.1~1.8	0.15~0.4
-30.0	30.0	240	32	0.9	16.0	39	160	0.2~1.8	0.15~0.4

- ★The dimension ℓ means the taper length from the top end to the front end reaming diameter φD.
- ★We would recommend you to use the NIKKEN reamer with NIKKEN Milling Chuck or Slim Chuck.
- ★The internal diameter "φd" is the front end bore without bottom teeth, thus please make sure that the predrilled hole is always larger than "φd".
- ★Please use Right Hand Helical Reamer P.254 for the hole with no room of swarf or blind hole.

FMM (Morse Taper Shank)



φ8~φ100 with every 1mm increment is standard.

MIN. Reamer Dia: φ6mm

Code No.	D _{H7}	L	MT No.	ℓ	d	ℓ ₁	ℓ ₂	Removal φ	Feed mm/rev
FMM- 8.0	8.0	150	1	0.6	4.0	25	84.5	0.1~0.6	0.1~0.3
- 9.0	9.0	165	1	0.6	4.5	25	99.5	0.1~0.6	0.1~0.3
- 10.0	10.0	165	1	0.6	5.0	29	99.5	0.1~0.6	0.1~0.3
- 11.0	11.0	170	1	0.6	5.0	29	104.5	0.1~0.6	0.1~0.3
- 12.0	12.0	175	1	0.6	6.0	29	109.5	0.1~0.8	0.1~0.3
- 13.0	13.0	180	1	0.6	6.0	29	114.5	0.1~0.8	0.1~0.3
- 14.0	14.0	180	1	0.6	7.0	29	114.5	0.1~0.8	0.1~0.3
- 15.0	15.0	160	2	0.6	7.0	29	80	0.1~1.0	0.1~0.3
- 16.0	16.0	165	2	0.6	7.0	30	85	0.1~1.0	0.1~0.3
- 18.0	18.0	170	2	0.6	9.0	30	90	0.1~1.0	0.1~0.3
- 20.0	20.0	180	2	0.6	10.0	30	100	0.1~1.5	0.1~0.3
- 22.0	22.0	190	2	0.6	11.0	33.5	110	0.1~1.5	0.1~0.3
- 24.0	24.0	225	3	0.6	12.0	33.5	126	0.1~1.8	0.1~0.3
- 30.0	30.0	235	3	0.9	16.0	39	136	0.2~1.8	0.15~0.4
- 40.0	40.0	275	4	0.9	23.0	46	151	0.2~2.0	0.15~0.4
- 50.0	50.0	290	4	1.2	30.0	56	166	0.2~3.0	0.2~0.6
- 60.0	60.0	295	4	1.2	40.0	50	171	0.2~3.0	0.2~0.6
- 70.0	70.0	330	5	1.2	50.0	50	174	0.2~3.0	0.2~0.6
- 80.0	80.0	340	5	1.2	58.0	50	184	0.2~3.0	0.25~0.8
- 90.0	90.0	340	5	1.2	65.0	50	184	0.2~3.0	0.25~0.8
-100.0	100.0	340	5	1.2	75.0	50	184	0.2~3.0	0.25~0.8

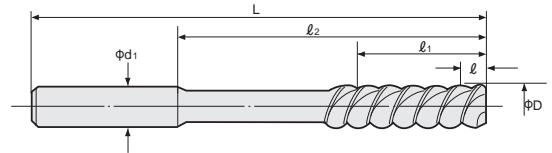
- ★The dimension ℓ means the taper length from the top end to the front end reaming diameter φD.
- ★MT shank size for reamer diameter : ~φ14mm : MT1, φ15~23mm : MT2, φ24~32mm : MT3, φ33~62mm : MT4, φ63mm~ : MT5.
- ★The internal diameter "φd" is the front end bore without bottom teeth, thus please make sure that the predrilled hole is always larger than "φd".
- ★Please use Right Hand Helical Reamer P.254 for the hole with no room of swarf or blind hole.

NIKKEN CARBIDE BROACH REAMER

NIKKEN

SX (Straight Shank)

Through Hole 



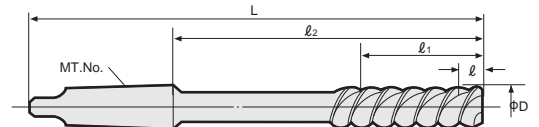
φ2~φ14 with every 1mm increment is standard. φ15~φ30 with every 1mm increment is semi-standard.

Code No.	D _{H7}	L	φ _{d_{1H7}}	l	l ₁	l ₂	Removal φ	Feed mm/rev
SX- 2.0	2.0	55	2	4.6	16	35	0.1~0.3	0.1~0.2
- 3.0	3.0	60	3	4.6	16	35	0.1~0.3	0.1~0.2
- 4.0	4.0	60	4	4.6	18	35	0.1~0.3	0.15~0.2
- 5.0	5.0	75	5	5.7	22	45	0.2~0.4	0.15~0.2
- 6.0	6.0	100	6	5.7	25	65	0.2~0.4	0.15~0.3
- 7.0	7.0	110	8	7.0	25	70	0.2~0.4	0.15~0.3
- 8.0	8.0	125	8	7.0	25	85	0.2~0.4	0.15~0.3
- 9.0	9.0	135	10	7.0	25	90	0.2~0.4	0.15~0.3
-10.0	10.0	150	10	7.0	29	100	0.2~0.4	0.15~0.3
-11.0	11.0	155	12	7.0	29	105	0.2~0.4	0.15~0.3
-12.0	12.0	160	12	7.0	29	105	0.2~0.4	0.15~0.3
-13.0	13.0	165	12	7.0	29	110	0.2~0.4	0.15~0.3
-14.0	14.0	170	16	7.0	29	115	0.2~0.4	0.15~0.3
-15.0	15.0	180	16	7.0	29	120	0.2~0.4	0.15~0.3
-16.0	16.0	185	16	7.0	30	125	0.2~0.4	0.2~0.3
-17.0	17.0	185	16	7.0	30	125	0.2~0.4	0.2~0.3
-18.0	18.0	195	20	7.0	30	130	0.2~0.4	0.2~0.4
-19.0	19.0	195	20	7.0	30	130	0.2~0.4	0.2~0.4
-20.0	20.0	205	20	7.0	30	140	0.2~0.4	0.2~0.4
-22.0	22.0	215	20	8.0	33.5	150	0.2~0.5	0.2~0.4
-24.0	24.0	230	25	8.0	33.5	160	0.2~0.5	0.2~0.4
-26.0	26.0	230	25	8.0	33.5	160	0.2~0.5	0.2~0.4
-28.0	28.0	240	32	8.0	39	160	0.2~0.5	0.2~0.4
-30.0	30.0	240	32	8.0	39	160	0.2~0.5	0.2~0.4

★The dimension *l* means the taper length from the top end to the front end reaming diameter φD.
★We would recommend you to use the NIKKEN reamer with NIKKEN Milling Chuck or Slim Chuck.

MX (Morse Taper Shank)

Through Hole 



φ6~φ50 with every 1mm increment is standard.

Code No.	D _{H7}	L	MT No.	l	l ₁	l ₂	Removal φ	Feed mm/rev
MX- 6.0	6.0	130	1	5.7	25	64.5	0.2~0.4	0.15~0.3
- 7.0	7.0	140	1	7.0	25	74.5	0.2~0.4	0.15~0.3
- 8.0	8.0	150	1	7.0	25	84.5	0.2~0.4	0.15~0.3
- 9.0	9.0	165	1	7.0	25	99.5	0.2~0.4	0.15~0.3
-10.0	10.0	165	1	7.0	29	99.5	0.2~0.4	0.15~0.3
-11.0	11.0	170	1	7.0	29	104.5	0.2~0.4	0.15~0.3
-12.0	12.0	175	1	7.0	29	109.5	0.2~0.4	0.15~0.3
-13.0	13.0	180	1	7.0	29	114.5	0.2~0.4	0.15~0.3
-14.0	14.0	180	1	7.0	29	114.5	0.2~0.4	0.15~0.3
-15.0	15.0	200	2	7.0	29	120	0.2~0.4	0.15~0.3
-16.0	16.0	205	2	7.0	30	125	0.2~0.4	0.2~0.3
-17.0	17.0	205	2	7.0	30	125	0.2~0.4	0.2~0.3
-18.0	18.0	210	2	7.0	30	130	0.2~0.4	0.2~0.4
-19.0	19.0	210	2	7.0	30	130	0.2~0.4	0.2~0.4
-20.0	20.0	220	2	7.0	30	140	0.2~0.4	0.2~0.4
-22.0	22.0	230	2	8.0	33.5	150	0.2~0.5	0.2~0.4
-24.0	24.0	250	3	8.0	33.5	151	0.2~0.5	0.2~0.4
-26.0	26.0	255	3	8.0	33.5	156	0.2~0.5	0.2~0.4
-28.0	28.0	260	3	8.0	39	161	0.2~0.5	0.2~0.4
-30.0	30.0	260	3	8.0	39	161	0.2~0.5	0.2~0.4
-40.0	40.0	330	4	9.0	46	206	0.2~0.6	0.2~0.6
-50.0	50.0	385	4	10.3	56	261	0.3~0.8	0.3~0.6

★The dimension *l* means the taper length from the top end to the front end reaming diameter φD.
★MT shank size for reamer diameter: ~φ14mm: MT1, φ15~23mm: MT2, φ24~32mm: MT3, φ33~62mm: MT4, φ63mm~: MT5.

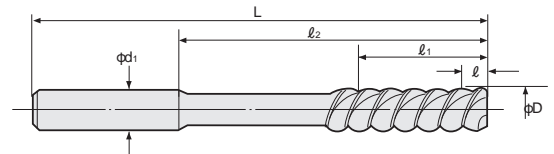
REAMER·DRILL

H.S.S. BROACH REAMER

NIKKEN

BRS (Straight Shank)

Through Hole



φ3~φ14 with every 0.1mm increment is standard. φ2~φ2.9 with every 0.1mm incremental, and φ15~φ30 with every 1mm incremental are semi-standard.

Code No.	D _{H7}	L	φd _{1h7}	ℓ	ℓ ₁	ℓ ₂	Removal φ	Feed mm/rev
BRS- 2.0	2.0	60	3	5.7	15	35	0.1~0.3	0.07~0.2
- 3.0	3.0	70	3	5.7	22	45	0.1~0.3	0.07~0.2
- 4.0	4.0	80	4	6.5	24	53	0.1~0.3	0.07~0.2
- 5.0	5.0	90	5	7.6	25	60	0.1~0.3	0.07~0.2
- 6.0	6.0	100	6	7.6	30	65	0.1~0.3	0.1~0.3
- 7.0	7.0	110	7	9.5	30	70	0.2~0.4	0.1~0.3
- 8.0	8.0	125	8	9.5	35	85	0.2~0.4	0.1~0.3
- 9.0	9.0	135	9	9.5	35	90	0.2~0.4	0.1~0.3
-10.0	10.0	150	10	9.5	40	100	0.2~0.4	0.1~0.3
-11.0	11.0	155	11	9.5	40	105	0.2~0.4	0.1~0.3
-12.0	12.0	160	12	9.5	40	105	0.2~0.4	0.1~0.3
-13.0	13.0	165	13	9.5	45	110	0.2~0.4	0.1~0.3
-14.0	14.0	170	14	9.5	45	115	0.2~0.4	0.1~0.3
-15.0	15.0	180	16	9.5	45	120	0.2~0.4	0.1~0.3
-16.0	16.0	185	16	11.5	45	125	0.2~0.5	0.1~0.3
-18.0	18.0	195	20	11.5	50	130	0.2~0.5	0.15~0.4
-20.0	20.0	205	20	11.5	55	140	0.2~0.5	0.15~0.4
-22.0	22.0	215	20	11.5	55	150	0.2~0.5	0.15~0.4
-24.0	24.0	230	25	11.5	60	160	0.2~0.5	0.15~0.4
-26.0	26.0	230	25	11.5	60	160	0.2~0.5	0.15~0.4
-28.0	28.0	240	32	11.5	60	160	0.2~0.5	0.2~0.6
-30.0	30.0	240	32	11.5	60	160	0.2~0.5	0.2~0.6

★The dimension ℓ means the taper length from the top end to the front end reaming diameter φD.

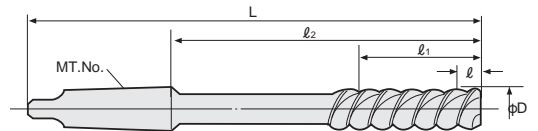
★We would recommend you to use the NIKKEN reamer with NIKKEN Milling Chuck or Slim Chuck.



When the incremental of the reamer diameter is 0.1mm for the straight shank broach reamer, the shank diameter of the reamer from φ3mm to φ14mm is the same diameter of the reamer. When the incremental of the reamer diameter is 0.01mm for the straight shank broach reamer; If the decimal two columns of the reamer diameter is lower equal to 3, the shank diameter is lower diameter of 0.1mm incremental. If the decimal two columns of the reamer diameter is higher equal to 4, the shank diameter is higher diameter of 0.1mm incremental.
e.g. Shank diameter of BRS-3.1: φ3.1mm, Shank diameter of BRS-3.13: φ3.1mm, Shank diameter of BRS-3.14: φ3.2mm

BRM (Morse Taper Shank)

Through Hole



φ3~φ30 with every 0.5mm increment, φ30~φ50 with every 1mm increment, and φ50~φ100 with every 5mm increment are standard.

Code No.	D _{H7}	L	MT No.	ℓ	ℓ ₁	ℓ ₂	Removal φ	Feed mm/rev
BRM- 3.0	3.0	115	1	5.7	24	49.5	0.1~0.3	0.07~0.2
- 4.0	4.0	115	1	6.5	24	49.5	0.1~0.3	0.07~0.2
- 5.0	5.0	120	1	7.6	25	54.5	0.1~0.3	0.07~0.2
- 6.0	6.0	130	1	7.6	30	64.5	0.2~0.4	0.1~0.3
- 7.0	7.0	140	1	9.5	35	74.5	0.2~0.4	0.1~0.3
- 8.0	8.0	150	1	9.5	40	84.5	0.2~0.4	0.1~0.3
- 9.0	9.0	165	1	9.5	40	99.5	0.2~0.4	0.1~0.3
-10.0	10.0	165	1	9.5	40	99.5	0.2~0.4	0.1~0.3
-11.0	11.0	170	1	9.5	40	104.5	0.2~0.4	0.1~0.3
-12.0	12.0	175	1	9.5	40	109.5	0.2~0.4	0.1~0.3
-13.0	13.0	180	1	9.5	40	114.5	0.2~0.4	0.1~0.3
-14.0	14.0	180	1	9.5	45	114.5	0.2~0.4	0.1~0.3
-15.0	15.0	200	2	9.5	45	120	0.2~0.4	0.1~0.3
-16.0	16.0	205	2	11.5	45	125	0.2~0.4	0.1~0.3
-18.0	18.0	210	2	11.5	50	130	0.2~0.4	0.15~0.4
-20.0	20.0	220	2	11.5	55	140	0.2~0.4	0.15~0.4
-22.0	22.0	230	2	11.5	55	150	0.2~0.4	0.15~0.4
-24.0	24.0	250	3	11.5	60	151	0.2~0.4	0.15~0.4
-26.0	26.0	255	3	11.5	60	156	0.2~0.4	0.15~0.4
-28.0	28.0	260	3	11.5	60	161	0.2~0.4	0.2~0.6
-30.0	30.0	260	3	11.5	60	161	0.2~0.4	0.2~0.6
-40.0	40.0	330	4	15.0	60	206	0.3~0.5	0.2~0.6
-50.0	50.0	385	5	15.0	70	229	0.3~0.5	0.3~0.8

★The dimension ℓ means the taper length from the top end to the front end reaming diameter φD.

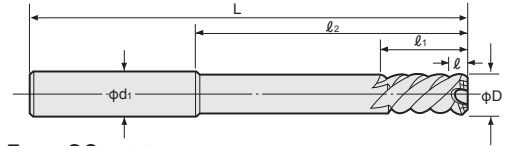
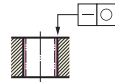
★MT shank size for reamer diameter: ~φ14mm: MT1, φ15~23mm: MT2, φ24~32mm: MT3, φ33~49mm: MT4, φ50mm~: MT5.

TOUGH CUT SKILL REAMER

NIKKEN

SRS (Straight Shank)

Through Hole



φ6~φ14 with every 0.5mm increment is standard. φ3, φ4, φ5 and φ15~φ30 with every 1mm incremental are semi-standard.

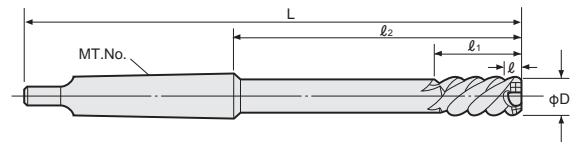
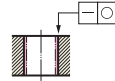
Code No.	D _{H7}	L	φd _{1h7}	ℓ	ℓ ₁	ℓ ₂	Removal φ	Feed mm/rev
SRS- 3.0	3.0	70	3	4.0	20	45	0.1~0.3	0.1~0.3
- 4.0	4.0	80	4	4.0	22	53	0.1~0.3	0.1~0.3
- 5.0	5.0	90	5	4.0	24	60	0.1~0.3	0.1~0.3
- 6.0	6.0	100	6	4.2	25	65	0.2~0.5	0.1~0.3
- 7.0	7.0	110	8	4.7	25	70	0.2~0.5	0.1~0.3
- 8.0	8.0	125	8	5.3	25	85	0.2~0.6	0.1~0.3
- 9.0	9.0	135	10	5.8	30	90	0.2~0.6	0.15~0.3
-10.0	10.0	150	10	6.8	30	100	0.2~0.6	0.15~0.3
-11.0	11.0	155	12	7.3	30	105	0.2~0.6	0.15~0.3
-12.0	12.0	160	12	7.5	30	105	0.2~0.8	0.15~0.3
-13.0	13.0	165	12	7.7	30	110	0.2~0.8	0.15~0.3
-14.0	14.0	170	16	7.9	35	115	0.2~0.8	0.15~0.3
-15.0	15.0	180	16	8.3	35	120	0.2~0.8	0.15~0.3
-16.0	16.0	185	16	9.6	35	125	0.2~1.0	0.15~0.3
-17.0	17.0	185	16	9.9	35	125	0.2~1.0	0.15~0.3
-18.0	18.0	195	20	10.6	40	130	0.2~1.0	0.15~0.5
-19.0	19.0	195	20	11.0	40	130	0.2~1.2	0.15~0.5
-20.0	20.0	205	20	11.0	40	140	0.2~1.2	0.15~0.5
-22.0	22.0	215	20	11.2	40	150	0.2~1.2	0.15~0.5
-24.0	24.0	230	25	11.8	40	160	0.2~1.2	0.2~0.5
-26.0	26.0	230	25	12.5	40	160	0.2~1.5	0.2~0.5
-28.0	28.0	240	32	12.5	45	160	0.25~1.5	0.2~0.5
-30.0	30.0	240	32	12.5	45	160	0.25~1.5	0.2~0.5

★The dimension ℓ means the taper length from the top end to the front end reaming diameter φD.

★We would recommend you to use the NIKKEN reamer with NIKKEN Milling Chuck or Slim Chuck.

SRM (Morse Taper Shank)

Through Hole



φ6~φ50 with every 0.5mm increment and φ51~φ100 with every 1mm increment is standard.

MIN. Reamer Dia: φ3mm

Code No.	D _{H7}	L	MT No.	ℓ	ℓ ₁	ℓ ₂	Removal φ	Feed mm/rev
SRM- 6.0	6.0	130	1	4.2	25	64.5	0.2~0.5	0.1~0.3
- 7.0	7.0	140	1	4.7	25	74.5	0.2~0.5	0.1~0.3
- 8.0	8.0	150	1	5.3	25	84.5	0.2~0.6	0.1~0.3
- 9.0	9.0	165	1	5.8	30	99.5	0.2~0.6	0.15~0.3
-10.0	10.0	165	1	6.8	30	99.5	0.2~0.6	0.15~0.3
-11.0	11.0	170	1	7.3	30	104.5	0.2~0.6	0.15~0.3
-12.0	12.0	175	1	7.5	30	109.5	0.2~0.8	0.15~0.3
-13.0	13.0	180	1	7.7	30	114.5	0.2~0.8	0.15~0.3
-14.0	14.0	180	1	7.9	35	114.5	0.2~0.8	0.15~0.3
-15.0	15.0	200	2	8.3	35	120	0.2~0.8	0.15~0.3
-16.0	16.0	205	2	9.6	35	125	0.2~1.0	0.15~0.3
-17.0	17.0	205	2	9.9	35	125	0.2~1.0	0.15~0.3
-18.0	18.0	210	2	10.6	40	130	0.2~1.0	0.15~0.5
-19.0	19.0	210	2	11.0	40	130	0.2~1.2	0.15~0.5
-20.0	20.0	220	2	11.0	40	140	0.2~1.2	0.15~0.5
-22.0	22.0	230	2	11.2	40	150	0.2~1.2	0.15~0.5
-24.0	24.0	250	3	11.8	40	151	0.2~1.2	0.2~0.5
-26.0	26.0	255	3	12.5	40	156	0.2~1.5	0.2~0.5
-28.0	28.0	260	3	12.5	45	161	0.25~1.5	0.2~0.5
-30.0	30.0	260	3	12.5	45	161	0.25~1.5	0.2~0.5
-40.0	40.0	330	4	13.5	52	206	0.25~1.5	0.25~0.6
-50.0	50.0	385	5	15.0	60	229	0.25~1.5	0.25~0.6

★The dimension ℓ means the taper length from the top end to the front end reaming diameter φD.

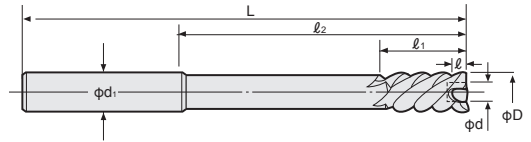
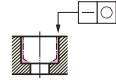
★MT shank size for reamer diameter: ~φ14mm: MT1, φ15~23mm: MT2, φ24~32mm: MT3, φ33~49mm: MT4, φ50mm~: MT5.

TOUGH CUT SKILL REAMER



SRS-F (Straight Shank)

Stepped Hole



φ6~φ14 with every 0.5mm increment is standard. φ4, φ5 and φ15~φ30 with every 0.5mm incremental are semi-standard.

Code No.	D _{H7}	L	φd _{H7}	ℓ	d	ℓ ₁	ℓ ₂	Removal φ	Feed mm/rev
SRS- 4.0F	4.0	80	4	0.6	1.5	22	53	0.1~0.3	0.07~0.2
- 5.0F	5.0	90	5	0.6	2.0	24	60	0.1~0.3	0.07~0.2
- 6.0F	6.0	100	6	0.6	3.0	25	65	0.1~0.5	0.07~0.2
- 7.0F	7.0	110	8	0.6	3.0	25	70	0.1~0.5	0.1~0.3
- 8.0F	8.0	125	8	0.6	3.5	25	85	0.1~0.6	0.1~0.3
- 9.0F	9.0	135	10	0.6	4.0	30	90	0.1~0.6	0.1~0.3
-10.0F	10.0	150	10	0.6	4.5	30	100	0.1~0.6	0.1~0.3
-11.0F	11.0	155	12	0.6	4.5	30	105	0.1~0.6	0.1~0.3
-12.0F	12.0	160	12	0.6	5.5	30	105	0.1~0.8	0.1~0.3
-13.0F	13.0	165	12	0.6	5.5	30	110	0.1~0.8	0.1~0.3
-14.0F	14.0	170	16	0.6	6.5	35	115	0.1~0.8	0.1~0.3
-15.0F	15.0	180	16	0.6	6.5	35	120	0.1~0.8	0.1~0.3
-16.0F	16.0	185	16	0.6	6.5	35	125	0.1~0.8	0.1~0.3
-17.0F	17.0	185	16	0.6	7.0	35	125	0.1~0.8	0.1~0.3
-18.0F	18.0	195	20	0.6	8.0	40	130	0.1~1.0	0.1~0.3
-19.0F	19.0	195	20	0.6	8.0	40	130	0.1~1.0	0.1~0.3
-20.0F	20.0	205	20	0.6	9.0	40	140	0.1~1.0	0.1~0.3
-22.0F	22.0	215	20	0.6	10.0	40	150	0.1~1.2	0.1~0.3
-24.0F	24.0	230	25	0.6	11.0	40	160	0.1~1.2	0.1~0.3
-25.0F	25.0	230	25	0.6	12.0	40	160	0.1~1.2	0.15~0.4
-26.0F	26.0	230	25	0.6	13.0	40	160	0.1~1.2	0.15~0.4
-28.0F	28.0	240	32	0.6	14.0	45	160	0.1~1.2	0.15~0.4
-30.0F	30.0	240	32	1.0	15.0	45	160	0.2~1.2	0.15~0.4

★The dimension ℓ means the taper length from the top end to the front end reaming diameter φD.

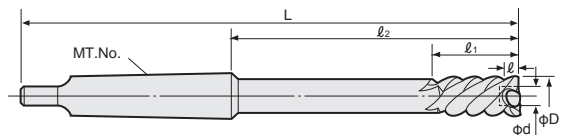
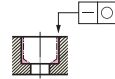
★We would recommend you to use the NIKKEN reamer with NIKKEN Milling Chuck or Slim Chuck.

★The internal diameter "φd" is the front end bore without bottom teeth, thus please make sure that the predrilled hole is always larger than "φd".

★Please use Right Hand Helical Reamer 右手用P.254 for the hole with no room of swarf or blind hole.

SRM-F (Morse Taper Shank)

Stepped Hole



φ6~φ100 with every 1mm increment is standard.

MIN. Reamer Dia: φ4mm

Code No.	D _{H7}	L	MT No.	ℓ	d	ℓ ₁	ℓ ₂	Removal φ	Feed mm/rev
SRM- 8.0F	8.0	150	1	0.6	3.5	25	84.5	0.1~0.6	0.1~0.3
- 9.0F	9.0	165	1	0.6	4.0	30	99.5	0.1~0.6	0.1~0.3
- 10.0F	10.0	165	1	0.6	4.5	30	99.5	0.1~0.6	0.1~0.3
- 11.0F	11.0	170	1	0.6	4.5	30	104.5	0.1~0.6	0.1~0.3
- 12.0F	12.0	175	1	0.6	5.5	30	109.5	0.1~0.8	0.1~0.3
- 13.0F	13.0	180	1	0.6	5.5	30	114.5	0.1~0.8	0.1~0.3
- 14.0F	14.0	180	1	0.6	6.5	35	114.5	0.1~0.8	0.1~0.3
- 15.0F	15.0	200	2	0.6	6.5	35	120	0.1~0.8	0.1~0.3
- 16.0F	16.0	205	2	0.6	6.5	35	125	0.1~0.8	0.1~0.3
- 17.0F	17.0	205	2	0.6	7.0	35	125	0.1~0.8	0.1~0.3
- 18.0F	18.0	210	2	0.6	8.0	40	130	0.1~1.0	0.1~0.3
- 19.0F	19.0	210	2	0.6	8.0	40	130	0.1~1.0	0.1~0.3
- 20.0F	20.0	220	2	0.6	9.0	40	140	0.1~1.0	0.1~0.3
- 22.0F	22.0	230	2	0.6	10.0	40	150	0.1~1.2	0.1~0.3
- 24.0F	24.0	250	3	0.6	11.0	40	151	0.1~1.2	0.1~0.3
- 26.0F	26.0	255	3	0.6	13.0	40	156	0.1~1.2	0.15~0.4
- 28.0F	28.0	260	3	0.6	14.0	45	161	0.1~1.2	0.15~0.4
- 30.0F	30.0	260	3	1.0	15.0	45	161	0.2~1.2	0.15~0.4
- 40.0F	40.0	330	4	1.0	22.0	52	206	0.2~1.5	0.15~0.4
- 50.0F	50.0	385	5	1.5	29.0	60	229	0.2~2.0	0.2~0.6
- 60.0F	60.0	400	5	1.5	39.0	60	244	0.2~2.0	0.2~0.6
- 70.0F	70.0	400	5	1.5	48.0	65	244	0.2~2.0	0.2~0.6
- 80.0F	80.0	400	5	1.5	55.0	65	244	0.2~2.0	0.25~0.6
- 90.0F	90.0	400	5	1.5	62.0	65	244	0.2~2.0	0.25~0.6
-100.0F	100.0	400	5	1.5	70.0	65	244	0.2~2.0	0.25~0.6

★The dimension ℓ means the taper length from the top end to the front end reaming diameter φD.

★MT shank size for reamer diameter : ~φ14mm : MT1, φ15~23mm : MT2, φ24~32mm : MT3, φ33~49mm : MT4, φ50mm~ : MT5.

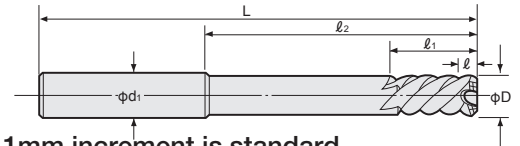
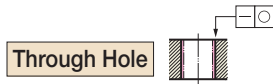
★The internal diameter "φd" is the front end bore without bottom teeth, thus please make sure that the predrilled hole is always larger than "φd".

★Please use Right Hand Helical Reamer 右手用P.254 for the hole with no room of swarf or blind hole.

NC SENSOR REAMER



NCS (Straight Shank)

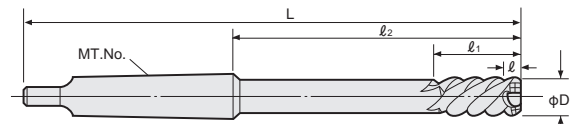
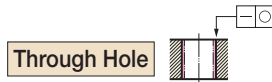


φ6~φ14 with every 0.5mm increment and φ15~φ100 with every 1mm increment is standard.

Code No.	D _{H7}	L	φd _{1h7}	l	l ₁	l ₂	Removal φ	Feed mm/rev
NCS- 3.0	3.0	70	3	4.0	20	45	0.1~0.3	0.1~0.3
- 4.0	4.0	80	4	4.0	22	53	0.1~0.3	0.1~0.3
- 5.0	5.0	90	5	4.0	24	60	0.1~0.3	0.1~0.3
- 6.0	6.0	100	6	4.2	25	65	0.2~0.5	0.1~0.3
- 7.0	7.0	110	8	4.7	25	70	0.2~0.5	0.1~0.3
- 8.0	8.0	125	8	5.3	25	85	0.2~0.6	0.1~0.3
- 9.0	9.0	135	10	5.8	30	90	0.2~0.6	0.15~0.3
-10.0	10.0	150	10	6.8	30	100	0.2~0.6	0.15~0.3
-11.0	11.0	155	12	7.3	30	105	0.2~0.6	0.15~0.3
-12.0	12.0	160	12	7.5	30	105	0.2~0.8	0.15~0.3
-13.0	13.0	165	12	7.7	30	110	0.2~0.8	0.15~0.3
-14.0	14.0	170	16	7.9	35	115	0.2~0.8	0.15~0.3
-16.0	16.0	185	16	9.6	35	125	0.2~1.0	0.15~0.3
-18.0	18.0	195	20	10.6	40	130	0.2~1.0	0.15~0.5
-20.0	20.0	205	20	11.0	40	140	0.2~1.2	0.15~0.5

★The dimension *l* means the taper length from the top end to the front end reaming diameter φD.
★We would recommend you to use the NIKKEN reamer with NIKKEN Milling Chuck or Slim Chuck.

NCM (Morse Taper Shank)



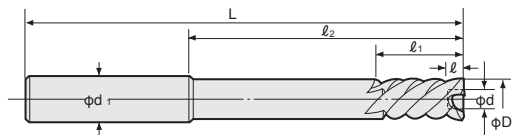
φ6~φ50 with every 0.5mm increment and φ51~φ100 with every 1mm increment is standard.

MIN. Reamer Dia: φ3mm

Code No.	D _{H7}	L	MT No.	l	l ₁	l ₂	Removal φ	Feed mm/rev
NCM- 8.0	8.0	150	1	5.3	25	84.5	0.2~0.6	0.1~0.3
- 9.0	9.0	165	1	5.8	30	99.5	0.2~0.6	0.15~0.3
-10.0	10.0	165	1	6.8	30	99.5	0.2~0.6	0.15~0.3
-11.0	11.0	170	1	7.3	30	104.5	0.2~0.6	0.15~0.3
-12.0	12.0	175	1	7.5	30	109.5	0.2~0.8	0.15~0.3
-13.0	13.0	180	1	7.7	30	114.5	0.2~0.8	0.15~0.3
-14.0	14.0	180	1	7.9	35	114.5	0.2~0.8	0.15~0.3
-15.0	15.0	200	2	8.3	35	120	0.2~0.8	0.15~0.3
-16.0	16.0	205	2	9.6	35	125	0.2~1.0	0.15~0.3
-18.0	18.0	210	2	10.6	40	130	0.2~1.0	0.15~0.5
-20.0	20.0	220	2	11.0	40	140	0.2~1.2	0.15~0.5
-30.0	30.0	260	3	12.5	45	161	0.25~1.5	0.2~0.5
-50.0	50.0	385	5	15.0	60	229	0.25~1.5	0.25~0.6

★The dimension *l* means the taper length from the top end to the front end reaming diameter φD.
★MT shank size for reamer diameter: ~φ14mm: MT1, φ15~23mm: MT2, φ24~32mm: MT3, φ33~49mm: MT4, φ50mm~: MT5.

NCS-F (Straight Shank)



φ6~φ14 with every 0.5mm increment and φ15~φ100 with every 1mm increment is standard.

Code No.	D _{H7}	L	φd _{1h7}	l	d	l ₁	l ₂	Removal φ	Feed mm/rev
NCS- 4.0F	4.0	80	4	0.6	1.5	22	53	0.1~0.3	0.07~0.2
- 5.0F	5.0	90	5	0.6	2.0	24	60	0.1~0.3	0.07~0.2
- 6.0F	6.0	100	6	0.6	3.0	25	65	0.1~0.5	0.07~0.2
- 7.0F	7.0	110	8	0.6	3.0	25	70	0.1~0.5	0.1~0.3
- 8.0F	8.0	125	8	0.6	3.5	25	85	0.1~0.6	0.1~0.3
- 9.0F	9.0	135	10	0.6	4.0	30	90	0.1~0.6	0.1~0.3
-10.0F	10.0	150	10	0.6	4.5	30	100	0.1~0.6	0.1~0.3
-11.0F	11.0	155	12	0.6	4.5	30	105	0.1~0.6	0.1~0.3
-12.0F	12.0	160	12	0.6	5.5	30	105	0.1~0.8	0.1~0.3
-13.0F	13.0	165	12	0.6	5.5	30	110	0.1~0.8	0.1~0.3
-14.0F	14.0	170	16	0.6	6.5	35	115	0.1~0.8	0.1~0.3
-15.0F	15.0	180	16	0.6	6.5	35	120	0.1~0.8	0.1~0.3
-20.0F	20.0	205	20	0.6	9.0	40	140	0.1~1.0	0.1~0.3

★The dimension *l* means the taper length from the top end to the front end reaming diameter φD. ★We would recommend you to use the NIKKEN reamer with NIKKEN Milling Chuck or Slim Chuck.
★The internal diameter "φd" is the front end bore without bottom teeth, thus please make sure that the predrilled hole is always larger than "φd".
★Please use Right Hand Helical Reamer ㊦ P.254 for the hole with no room of swarf or blind hole.

RIGHT HAND HELICAL REAMER

NIKKEN

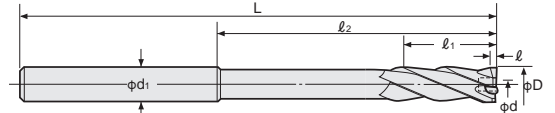
RSS-F (Straight Shank)

Blind Hole

RSS-F:HSS

RNS-F:Coated

RXS-F:Carbide



φ5~φ14 with every 1mm increment is standard. φ3, φ4, φ15~φ100 with every 1mm increment is semi-standard.

Code No.	D _{H7}	L	φd _{1h7}	ℓ	d	ℓ ₁	ℓ ₂	Removal φ	Feed mm/rev
RSS- 3.0F	3.0	70	3	0.6	1.5	20	45	0.1~0.3	0.1~0.3
- 4.0F	4.0	80	4	0.6	1.5	22	53	0.1~0.3	0.1~0.3
- 5.0F	5.0	90	5	0.6	2.0	24	60	0.1~0.3	0.1~0.3
- 6.0F	6.0	100	6	0.6	3.0	25	65	0.1~0.6	0.15~0.4
- 7.0F	7.0	110	8	0.6	3.0	25	70	0.1~0.6	0.15~0.4
- 8.0F	8.0	125	8	0.6	3.5	25	85	0.1~0.8	0.15~0.4
- 9.0F	9.0	135	10	0.6	4.0	30	90	0.1~0.8	0.15~0.4
-10.0F	10.0	150	10	0.6	4.5	30	100	0.1~1.0	0.15~0.4
-11.0F	11.0	155	12	0.6	4.5	30	105	0.1~1.0	0.15~0.4
-12.0F	12.0	160	12	0.6	5.5	30	105	0.1~1.2	0.15~0.4
-13.0F	13.0	165	12	0.6	5.5	30	110	0.1~1.2	0.15~0.4
-14.0F	14.0	170	16	0.6	6.5	35	115	0.1~1.5	0.15~0.4
-15.0F	15.0	180	16	0.6	6.5	35	120	0.1~1.5	0.15~0.4
-16.0F	16.0	185	16	0.6	6.5	35	125	0.1~1.5	0.15~0.4
-17.0F	17.0	185	16	0.6	7.0	35	125	0.1~2.0	0.2~0.5
-18.0F	18.0	195	20	0.6	8.0	40	130	0.1~2.0	0.2~0.5
-19.0F	19.0	195	20	0.6	8.0	40	130	0.1~2.0	0.2~0.5
-20.0F	20.0	205	20	0.6	9.0	40	140	0.1~2.0	0.2~0.5
-22.0F	22.0	215	20	0.6	10.0	40	150	0.1~2.0	0.2~0.5
-25.0F	25.0	230	25	0.6	12.0	40	160	0.1~3.0	0.2~0.5
-30.0F	30.0	240	32	0.9	15.0	45	160	0.2~3.0	0.25~0.7
-40.0F	40.0	285	32	0.9	22.0	52	205	0.2~3.0	0.25~0.7
-50.0F	50.0	310	32	1.2	29.0	60	230	0.25~3.0	0.25~0.7

★The dimension ℓ means the taper length from the top end to the front end reaming diameter φD. ★We would recommend you to use the NIKKEN reamer with NIKKEN Milling Chuck or Slim Chuck.
 ★Always make sure that the above reamer requires longer reamer tooth length (ℓ₁) than the hole length.
 ★The internal diameter "φd" is the front end bore without bottom teeth, thus please make sure that the predrilled hole is always larger than "φd".
 ★We would recommend the above reamer with oil hole as the cutting chips might twist around the reamer dependant on the materials.

NIKKEN SPECIAL REAMER SERIES

NIKKEN

●The following special feature reamers as well as the nonstandard size reamers (Each 0.01mm) are also available as option. Please contact with NIKKEN distributors for the nonstandard size reamers.

Stepped Reamer

●This reamer can ream the different size holes with one pass for rationalized operation.



Reamer with oil groove

●This is ideal for deep hole reaming which is difficult to supply the coolant to the bottom.



Semi Dry Reamer

●Semi Dry Reamer for clean environment is also available.



Reamer with Guide

●This reamer performs very well for deep hole required good concentricity.



Oil Hole Reamer

MIN. Reamer dia:φ6mm

The coolant is splashed over from the reamer front end, therefore this reamer is suitable for only NC Lathe and M/C, but also for NC Special Purpose machine and FMS Line Production.



Deep Hole Reamer

●MAX. length of approx. 30 times of diameter (D) is available as a guide line.



DLC Coated Reamer with Guide specially for Aluminum



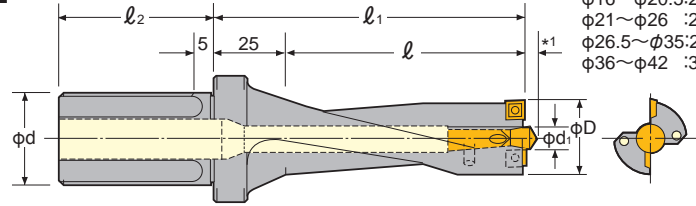
- The trial cutting on the same material as your work piece is recommended, because the reaming is the final process.
- The basic inspection charge is required for the inspection of your reamer, whether your reamer is re-ground or not.

COMBAT Z DRILL

Cost down can be achieved by improvement of drilling operation.



Dimensions of $\phi 16 \sim 42$ mm
COMBAT Z DRILL



*1 Dimension
 $\phi 16 \sim \phi 20.5$: 2.1mm
 $\phi 21 \sim \phi 26$: 2.4mm
 $\phi 26.5 \sim \phi 35$: 2.8mm
 $\phi 36 \sim \phi 42$: 3.4mm

$\phi 16 \sim \phi 38$
 $L/D=3$ or 4

$\phi 16 \sim \phi 35$ mm by every 0.5mm increment, $\phi 36 \sim \phi 60$ mm by every 1mm increment, $\phi 60 \sim \phi 80$ mm by every 5mm increment are standard.

Each 0.1mm increment drill is available as an option.

Drill Dia.	3D Series				4D Series				3D, 4D											
	Code No.		l	l_1	Code No.		l	l_1	ϕd	l_2	Pilot Drill	Insert Tip	Clamp Screw	Tip Clamp Handle						
	$\phi d - \phi D$	$-l$			$\phi d - \phi D$	$-l$														
16	ST20-COMZ16	- 50	50	75	ST20-COMZ16	- 65	65	90	20	43	9CMD5 $d_1=\phi 5$	9CMT4 2 pcs	M1840	T-6						
16.5	-COMZ16.5	- 50			-COMZ16.5	- 65														
17	-COMZ17	- 50	-COMZ17	- 65																
17.5	-COMZ17.5	- 50	-COMZ17.5	- 65																
18	-COMZ18	- 55	75	100	-COMZ18	- 75														
18.5	-COMZ18.5	- 55			-COMZ18.5	- 75														
19	-COMZ19	- 55	-COMZ19	- 75																
19.5	-COMZ19.5	- 60	60	85	-COMZ19.5	- 80														
20	-COMZ20	- 60			-COMZ20	- 80														
20.5	-COMZ20.5	- 60	-COMZ20.5	- 80																
21	ST25-COMZ21	- 60	60	85	ST25-COMZ21	- 80	80	105					25		53	9CMD6 $d_1=\phi 6$	9CMT6 2 pcs	M2560	T-8	
21.5	-COMZ21.5	- 60			-COMZ21.5	- 80														
22	-COMZ22	- 65	65	90	-COMZ22	- 85														
22.5	-COMZ22.5	- 65			-COMZ22.5	- 85														
23	-COMZ23	- 70	70	95	-COMZ23	- 90														
23.5	-COMZ23.5	- 70			-COMZ23.5	- 90														
24	-COMZ24	- 70	-COMZ24	- 90																
24.5	-COMZ24.5	- 70	-COMZ24.5	- 90																
25	-COMZ25	- 75	75	100	-COMZ25	-100														
25.5	-COMZ25.5	- 75			-COMZ25.5	-100														
26	-COMZ26	- 75	-COMZ26	-100																
26.5	ST32-COMZ26.5	-80N	80	105	ST32-COMZ26.5	-110N	110	135	32	58	9CMD8 $d_1=\phi 8$	9CMT7 2 pcs		M3070				T-10		
27	-COMZ27	- 80			-COMZ27	-110														
27.5	-COMZ27.5	- 80	-COMZ27.5	-110																
28	-COMZ28	- 80	-COMZ28	-110																
28.5	-COMZ28.5	- 90	90	115	-COMZ28.5	-120														
29	-COMZ29	- 90			-COMZ29	-120														
29.5	-COMZ29.5	- 90	-COMZ29.5	-120																
30	-COMZ30	- 90	-COMZ30	-120																
30.5	-COMZ30.5	- 90	-COMZ30.5	-120																
31	-COMZ31	- 90	-COMZ31	-120																
31.5	-COMZ31.5	- 90	-COMZ31.5	-120																
32	-COMZ32	- 90	-COMZ32	-120																
32.5	-COMZ32.5	- 90	-COMZ32.5	-120																
33	-COMZ33	- 90	-COMZ33	-120																
33.5	-COMZ33.5	- 90	-COMZ33.5	-120																
34	-COMZ34	- 90	-COMZ34	-120																
34.5	-COMZ34.5	- 90	-COMZ34.5	-120																
35	-COMZ35	- 90	-COMZ35	-120																
36	-COMZ36	-100	100	125	-COMZ36	-140	125	125	32	58	9CMD8 $d_1=\phi 8$	9CMT7 2 pcs	M3070	T-10						
37	-COMZ37	-100			-COMZ37	-140														
38	-COMZ38	-100	-COMZ38	-140																

★2 off Pilot Drill, one set of Insert and Insert Clamp Handle are supplied as standard.

★Please refer P.106 for Centre Through Side Lock Holder, P.108 for Flange Through Side Lock Holder and P.111 for Oil Hole Holder for COMBAT Z Drill at M/C use.

REAMER-DRILL

COMBAT Z DRILL

Cost down can be achieved by improvement of drilling operation.



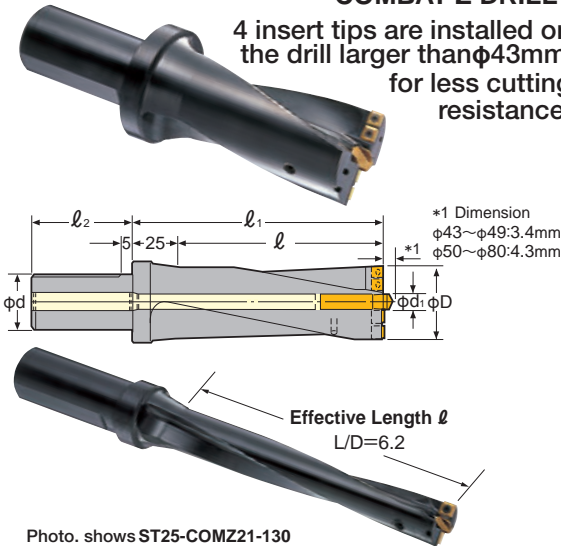
φ39~φ49 L/D=2, 3 or 4

Drill Dia.	2D Series				3D Series				4D Series			2D,3D,4D				
	Code No.	ℓ	ℓ ₁	Code No.	ℓ	ℓ ₁	Code No.	ℓ	ℓ ₁	φ _d	ℓ ₂	Pilot Drill	Insert Tip	Clamp Screw	Tip Clamp Handle	
																φ _d -φD -ℓ
39	ST32-COMZ39- 80	80	105	ST32-COMZ39-120	120	145	ST32-COMZ39-160	160	185	32	58	9CMD10 d:=φ10	9CMT9 2 pcs	M4090	T-15	
40	-COMZ40- 80			-COMZ40-120			-COMZ40-160									
41	-COMZ41- 80			-COMZ41-120			-COMZ41-160									
42	-COMZ42- 80			-COMZ42-120			-COMZ42-160									
43	-COMZ43- 80			-COMZ43-120			-COMZ43-160									
44	-COMZ44- 80			-COMZ44-120			-COMZ44-160									
45	-COMZ45- 80			-COMZ45-120			-COMZ45-160									
46	-COMZ46- 80			-COMZ46-120			-COMZ46-160									
47	-COMZ47- 80			-COMZ47-120			-COMZ47-160									
48	-COMZ48- 80			-COMZ48-120			-COMZ48-160									
49	-COMZ49- 80	-COMZ49-120	-COMZ49-160													

Dimensions of φ43mm or larger

COMBAT Z DRILL

4 insert tips are installed on the drill larger than φ43mm for less cutting resistance.



The extended drill longer than L/D=5 or with chamfering tool are available as an option.
MIN. order quantity of special drill is 2 off.

φ50~φ80 L/D=2

Drill Dia.	2D Series				φ _d	ℓ ₂	Pilot Drill	Insert Tip	Clamp Screw	Tip Clamp Handle							
	Code No.	ℓ	ℓ ₁	φ _d													
											φ _d -φD -ℓ						
50	ST32-COMZ50-100	100	125	32	58	9CMD12 d:=φ12	9CMT6 4 pcs	M2560	T-8								
51	-COMZ51-100																
52	-COMZ52-100																
53	-COMZ53-100																
54	-COMZ54-100																
55	-COMZ55-100																
56	-COMZ56-110									110	135	40	68	9CMD12 d:=φ12	9CMT7 4 pcs	M3070	T-10
57	-COMZ57-110																
58	-COMZ58-110																
59	-COMZ59-110	120	145	40	68	9CMD12 d:=φ12	9CMT7 4 pcs	M3070	T-10								
60	ST40-COMZ60-120																
65	-COMZ65-120																
70	-COMZ70-130																
75	-COMZ75-130	130	155	40	68	9CMD12 d:=φ12	9CMT9 4 pcs	M4090	T-15								
80	-COMZ80-150	150	175														

★2 off Pilot Drill, one set of Insert and Insert Clamp Handle are supplied as standard.
★Please refer P.106 for Centre Through Side Lock Holder, P.108 for Flange Through Side Lock Holder and P.111 for Oil Hole Holder for COMBAT Z Drill on M/C.

Insert Tip for COMBAT Z DRILL

Code No.	Insert Tip					ISO Code No.	Grade	Material	Applicable Drill	
	Dimensions	φD	T	φ _d	Nose Radius					
9CMT4		4.76	1.98	1.9	0.4	MPMT04T104	Coated (PR630)	Steel Cast Iron	COMZ16~20.5	
9CMT6		6.35	2.38	2.8					COMZ21~26 COMZ43~55	
9CMT7		7.94	3.18	3.4	0.8				MPMT070308	COMZ26.5~35 COMZ56~65
9CMT9		9.525		4.4					MPMT090308	COMZ36~42 COMZ66~80

★The Rhomboid insert tips are installed on the drill. Total 4 corners at 2 external and 2 internal diameters can be used. Please pay attention to install the insert into the pockets correctly.
★The spare Insert Tips are available per a box (10 off).

COMBAT Z DRILL Economical Cutting Condition

- For Steel/Cast Iron
"40,000" is the basic figure for cutting speed, and the rotation speed could be obtained by dividing above figure by the drill diameter.
e.g. for φ32mm diameter drill: 40,000 ÷ 32 = 1,250 (min⁻¹)
- For Stainless Steel/Steel Plate SS41
"25,000" is the basic figure for cutting speed, and the rotation speed could be obtained by dividing above figure by the drill diameter.
e.g. for φ32mm diameter drill: 25,000 ÷ 32 = 780 (min⁻¹)
- Feed Rate

Drill Dia	φ16~φ26	φ26.5~φ42	φ43~φ85
Mild Steel Feed per rev.	0.1~0.15	0.1~0.2	0.15~0.2
Cast Iron Feed per rev.	0.15~0.2	0.2~0.3	0.2~0.35

★How to install Insert Tips

★Coolant higher than 0.5MPa pressure must be supplied.

★For Stainless Steel/Steel Plate, even the cutting speed is reduced to meet with the materials, please do not reduce the feed rate and keep it as for steel.

★For tough materials, e.g. steel plate, please use stepped feed (G73) for breaking the swarf.

★This drill is suitable for offset hole, or inter-merged twin bore, but not suitable for stacked plate drilling.

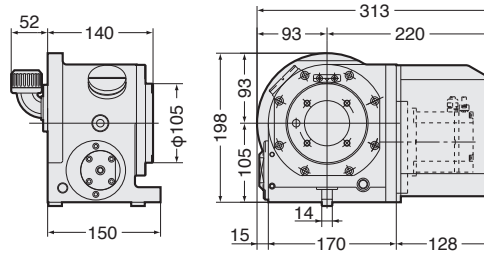
REAMER-DRILL

CNC ROTARY TABLE with α 21 CONTROLLER



External dimensions will be different according to the type of the servo motors. Dimensions with NIKKEN α 21 controller are shown. Please contact with us for CAD data (2D:DXF, 3D:PARASOLID) of each dimension.

CNC105AA21-04



SMALL CNC ROTARY TABLE $\phi 105$ mm

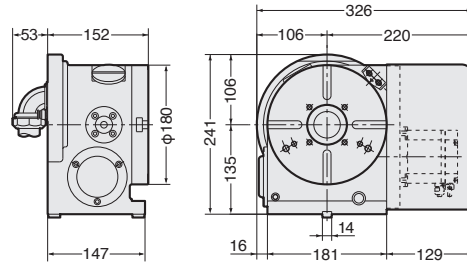
- Diameter of Table : $\phi 105$ mm
- MAX. Work Load : 60kg (Horizontal) 30kg (Vertical)
- MAX. Rotation Speed : 22.2 (min^{-1}), **44.4 (min^{-1})**
- Indexing Accuracy : ± 30 sec.
- Net Weight : 32kg
- Servo Motor : AC*A*iF1
- Spindle Hole : $\phi 60$ mm $H7 \times \phi 30$ mm Through Hole

Air purge function is provided.

CNC180AA21-04



CNC180AA21-04 (400W) is standard. CNC180AA21-08 (750W) and CNC180AA21-06 (High Torque) are available.



$\phi 180$ mm type CNC ROTARY TABLE

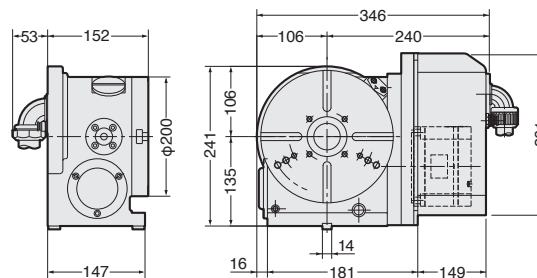
- Diameter of Table : $\phi 180$ mm
- MAX. Work Load : 200kg (Horizontal) 100kg (Vertical)
- MAX. Rotation Speed : 22.2 (min^{-1}), **44.4 (min^{-1})**
- Indexing Accuracy : ± 20 sec.
- Net Weight : 45kg
- Servo Motor : AC*A*iF2
- Spindle Hole : $\phi 60$ mm $H7 \times \phi 40$ mm Through Hole

Air purge function is provided.

CNC202AA21-08



CNC202AA21-08 (750W) is standard. CNC202AA21-06 (High Torque) is available.

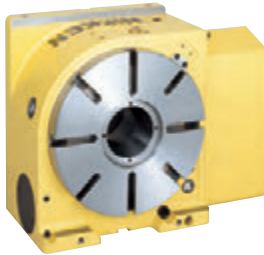


$\phi 202$ mm type CNC ROTARY TABLE

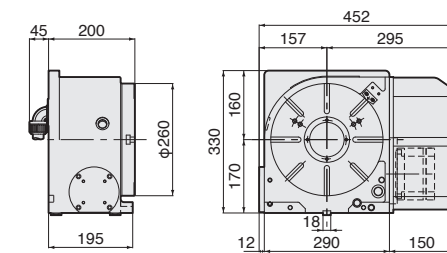
- Diameter of Table : $\phi 200$ mm
- MAX. Work Load : 200kg (Horizontal) 100kg (Vertical)
- MAX. Rotation Speed : 22.2 (min^{-1}), **44.4 (min^{-1})**
- Indexing Accuracy : ± 20 sec.
- Net Weight : 55kg
- Servo Motor : AC*A*iF4
- Spindle Hole : $\phi 60$ mm $H7 \times \phi 40$ mm Through Hole

Air purge function is provided.

CNC260AA21-08



CNC260AA21-08 (750W) is standard. CNC260AA21-06 (High Torque) is available.



$\phi 260$ mm type CNC ROTARY TABLE

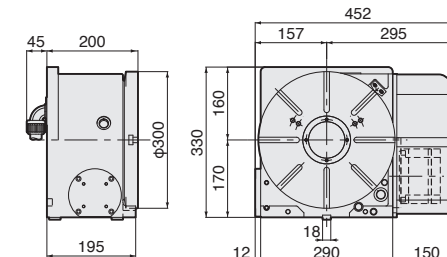
- Diameter of Table : $\phi 260$ mm
- MAX. Work Load : 300kg (Horizontal) 150kg (Vertical)
- MAX. Rotation Speed : 16.6 (min^{-1}), **33.3 (min^{-1})**
- Indexing Accuracy : 20sec.
- Net Weight : 115kg
- Servo Motor : AC*A*iF4
- Spindle Hole : $\phi 80$ mm $H7$ Through Hole

For the rotary table with pneumatic brake, air purge function is provided inside the motor cover as standard.

CNC302AA21-08



CNC302AA21-08 (750W) is standard. CNC302AA21-06 (High Torque) is available.



$\phi 300$ mm type CNC ROTARY TABLE

- Diameter of Table : $\phi 300$ mm
- MAX. Work Load : 300kg (Horizontal) 150kg (Vertical)
- MAX. Rotation Speed : 16.6 (min^{-1}), **33.3 (min^{-1})**
- Indexing Accuracy : 20sec.
- Net Weight : 120kg
- Servo Motor : AC*A*iF4
- Spindle Hole : $\phi 80$ mm $H7$ Through Hole

For the rotary table with pneumatic brake, air purge function is provided inside the motor cover as standard.

High speed rotation Z series is available for all models of CNC rotary table. e.g. CNCZ260AA21

Guide Line of MAX. Unbalancing Load

High speed CNCZ series can not be recommended for the application with large unbalancing load. Please select standard CNC series.

MAX. Unbalancing Load	CNC180	CNC202	CNC260	CNC302
10 Nm	CNC180AA21-04			
20	CNC180AA21-08	CNC202AA21-08		
30			CNC260AA21-08	CNC302AA21-08
50	CNC180AA21-06	CNC202AA21-06	CNC260AA21-06	CNC302AA21-06

This is just a guide line. For high precision machining, the balancing of the rotary table is strongly recommended with counter balance weight.



Please refer to CNC ROTARY TABLE Catalogue.

CNC ROTARY TABLE with α 21 CONTROLLER



External dimensions will be different according to the type of the servo motors. Dimensions with NIKKEN α 21 controller are shown. Please contact with us for CAD data (2D:DXF, 3D:PARASOLID) of each dimension.

CNC321, 401A21-18

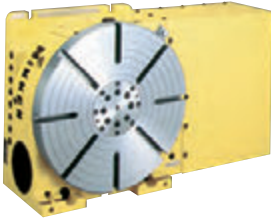
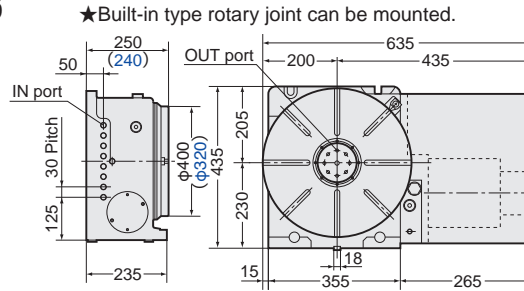


Photo shows with rotary joint (Option).

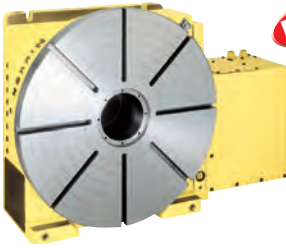


$\phi 321, 401$ mm type CNC ROTARY TABLE

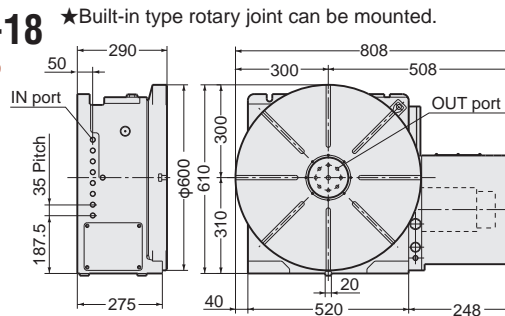
- Diameter of Table : $\phi 320, 400$ mm
- MAX. Work Load : 500kg (Horizontal) 250kg (Vertical)
- MAX. Rotation Speed : 22.2 (min^{-1}), 44.4 (min^{-1})
- Indexing Accuracy : 15sec.
- Net Weight : 200, 230kg
- Servo Motor : ACQiF12 / QiF22
- Spindle Hole : $\phi 105$ mm H7 Through Hole

★ Please contact us for the dimension of CNC321A21-18.

CNC501, 601, 802A21-18



NEW



$\phi 501, 601, 802$ mm type CNC ROTARY TABLE

- Diameter of Table : $\phi 500, 600, 800$ mm
- MAX. Work Load : 800kg (Horizontal) 400kg (Vertical)
- MAX. Rotation Speed : 16.6 (min^{-1}), 33.3 (min^{-1})
- Indexing Accuracy : 15sec.
- Net Weight : 470, 500, 1100kg
- Servo Motor : ACQiF12 / QiF22
- Spindle Hole : $\phi 130$ mm H7 Through Hole

★ Please contact us for the dimension of CNC501, 802A21-18.

CNC1000, 1200A21

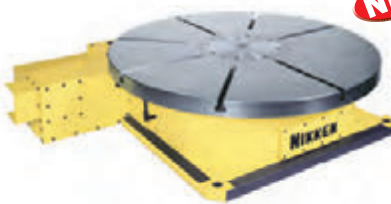
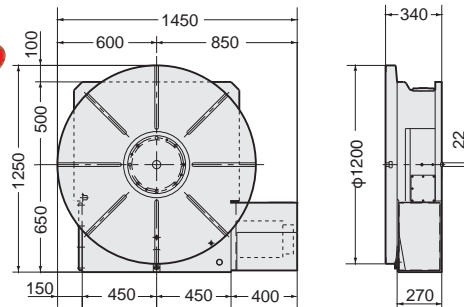


Photo shows with center socket (Option).

NEW



$\phi 1200$ mm type CNC ROTARY TABLE

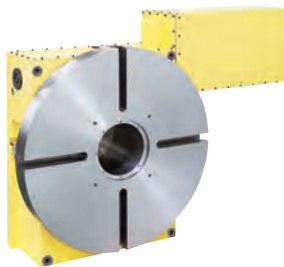
- Diameter of Table : $\phi 1200$ mm
- MAX. Work Load : 5000kg (Horizontal)
- MAX. Rotation Speed : 2.7 (min^{-1})
- Indexing Accuracy : 5.5sec.
- Net Weight : 1850kg
- Servo Motor : ACQiF22
- Spindle H $\phi 300$ mm H7 Through Hole

★ Ultra precision of ± 3 sec. is available as an option. There is no through hole on the rotary table due to the rotary encoder for ultra precision option.

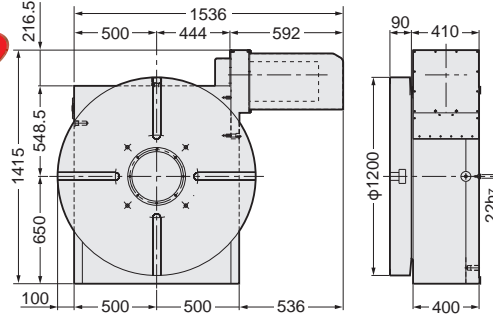
★ Please contact us for the dimension of CNC1000A21.

★ Code No. will be varied according to the servo motor capacity. e.g CNC1000A21-44 (4.4KW Motor)

CNC1201A21



NEW



$\phi 1200$ mm type CNC ROTARY TABLE for Heavy Duty

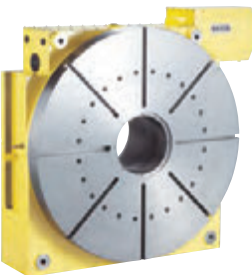
- Diameter of Table : $\phi 1200$
- MAX. Work Load : 13000kg (Horizontal) 6500kg (Vertical)
- MAX. Rotation Speed : 2.7 (min^{-1})
- Indexing Accuracy : 15, ± 3 sec.
- Net Weight : 3500kg
- Servo Motor : ACQiF30
- Spindle Hole : $\phi 300$ H7 Through Hole

★ Ultra precision of ± 3 sec. is available as an option. There is no through hole on the rotary table due to the rotary encoder for ultra precision option.

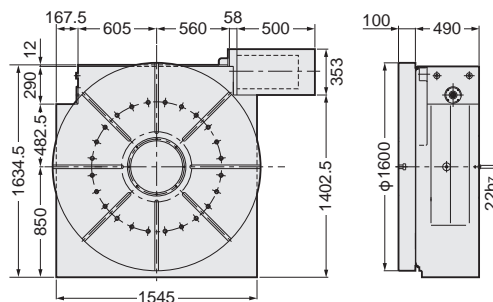
★ Please contact us for the dimension of CNC1000A21.

★ Code No. will be varied according to the servo motor capacity. e.g CNC1201A21-110 (11KW Motor)

CNC1600, 2000A21



NEW



$\phi 1600$ mm type CNC ROTARY TABLE for Heavy Duty

- Diameter of Table : $\phi 1600$
- MAX. Work Load : 3000kg (Horizontal) 1000kg (Vertical)
- MAX. Rotation Speed : 2.7 (min^{-1})
- Indexing Accuracy : 15, ± 3 sec.
- Net Weight : 6300kg
- Servo Motor : ACQiF30
- Spindle Hole : $\phi 400$ H7 Through Hole

★ Ultra precision of ± 3 sec. is available as an option. There is no through hole on the rotary table due to the rotary encoder for ultra precision option.

★ Please contact us for the dimension of CNC2000A21.

★ Code No. will be varied according to the servo motor capacity. e.g CNC1600A21-44 (4.4KW Motor)

The specification of the large rotary table will be varied according to your application.

1. With/without T slot, Width of T slot
2. Spindle hole dimension...Centre socket for centring is normally attached.
3. Layout of the rotary table...Vertical use, horizontal use, vertical and horizontal use
4. Total reduction ratio...Suitable capacity of the servo motor will be selected.



Please refer to CNC ROTARY TABLE Catalogue.

Tilting Rotary Table with α 21 Controller

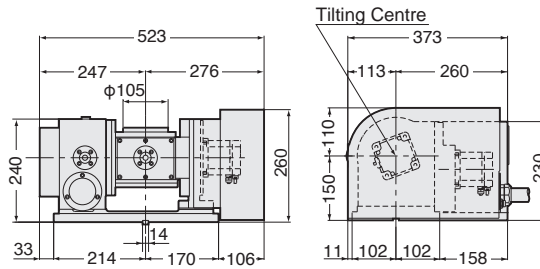
NIKKEN

External dimensions will be different according to the type of the servo motors. Dimensions with NIKKEN α 21 controller are shown. Please contact with us for CAD data (2D:DXF, 3D:PARASOLID) of each dimension.

5AX-130WAA21



Photo shows with ϕ 130mm plate.
Rotary axis cable stays.

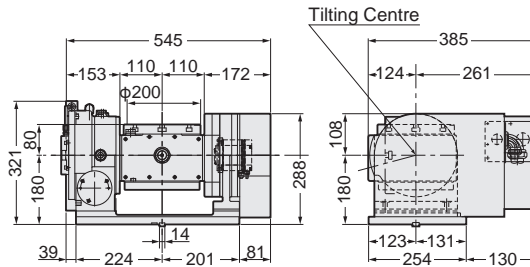


ϕ 130mm type 5AX TILTING ROTARY TABLE

- Diameter of Table : ϕ 130mm
- MAX. Work Load : 50kg (Horizontal) 25kg (Vertical)
- MAX. Rotation Speed : 22.2 (min^{-1})
- Indexing Accuracy : \pm 30sec., 60sec.
- Net Weight : 115kg
- Servo Motor : AC*Q*iF2, AC*Q*iF2
- Spindle Hole : ϕ 60mm $H7$ \times ϕ 30mm Through Hole
- Tilting Angle : 0° ~ 105°

Motor capacity of rotary axis and tilting axis is added at the end of Code No. e.g 5AX-130WAA21-0404

5AX-201WAA21

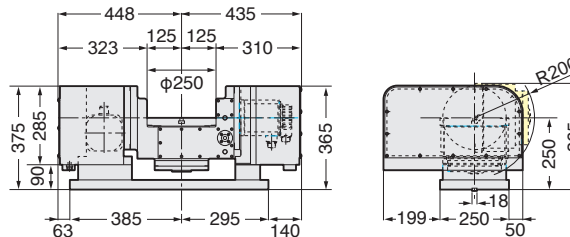


ϕ 200mm type 5AX TILTING ROTARY TABLE

- Diameter of Table : ϕ 200mm
- MAX. Work Load : 60kg (Horizontal) 40kg (Vertical)
- MAX. Rotation Speed : 22.2 (min^{-1})
- Indexing Accuracy : \pm 20sec., 60sec.
- Net Weight : 160kg
- Servo Motor : AC*Q*iF2, AC*Q*iS4
- Spindle Hole : ϕ 60mm $H7$ \times ϕ 50mm Through Hole
- Tilting Angle : 0° ~ 105°

Motor capacity of rotary axis and tilting axis is added at the end of Code No. e.g 5AX-201WAA21-0408

5AX-250WA21

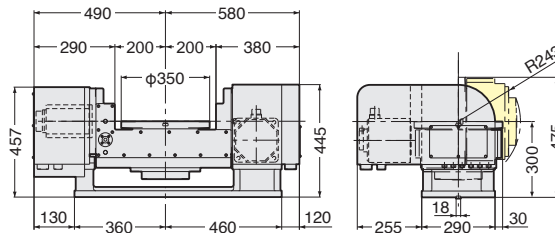


ϕ 250mm type 5AX TILTING ROTARY TABLE

- Diameter of Table : ϕ 250mm
- MAX. Work Load : 80kg (Horizontal) 50kg (Vertical)
- MAX. Rotation Speed : 11.1 (min^{-1})
- Indexing Accuracy : 20sec., 60sec.
- Net Weight : 290kg
- Servo Motor : AC*Q*iF4, AC*Q*iF4
- Spindle Hole : ϕ 60mm $H7$ \times ϕ 55mm Through Hole
- Tilting Angle : 0° ~ 105°

Motor capacity of rotary axis and tilting axis is added at the end of Code No. e.g 5AX-250WA21-1313

5AX-350WA21



ϕ 350mm type 5AX TILTING ROTARY TABLE

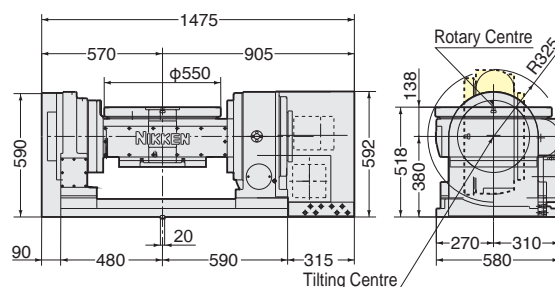
- Diameter of Table : ϕ 350mm
- MAX. Work Load : 200kg (Horizontal) 200kg (Vertical)
- MAX. Rotation Speed : 22.2 (min^{-1})
- Indexing Accuracy : 20sec., 60sec.
- Net Weight : 420kg
- Servo Motor : AC*Q*iF8, AC*Q*iF12
- Spindle Hole : ϕ 80mm $H7$ Through Hole
- Tilting Angle : 0° ~ 105°

Motor capacity of rotary axis and tilting axis is added at the end of Code No. e.g 5AX-350WA21-1318

5AX-550WA21



Photo shows with centre socket(option).
Rotary axis cable stays.



ϕ 550mm type 5AX TILTING ROTARY TABLE

- Diameter of Table : ϕ 550mm
- MAX. Work Load : 500kg (Horizontal) 300kg (Vertical)
- MAX. Rotation Speed : 8.3 (min^{-1})
- Indexing Accuracy : 20sec., 60sec.
- Net Weight : 1150kg
- Servo Motor : AC*Q*iF12, AC*Q*iF12
- Spindle Hole : ϕ 130mm $H7$ Through Hole
- Tilting Angle : 0° ~ \pm 105 $^{\circ}$

Motor capacity of rotary axis and tilting axis is added at the end of Code No. e.g 5AX-550WA21-1818



CNC ROTARY TABLE CONTROLLER

NIKKEN

- **Minimum Command Incremental : 0.001° or 1sec.**
 X21 controller can drive all models of NIKKEN CNC Rotary Table.
- **Single M Signal provides Various Automatic Operation.**
 Any unequal dividing, equal dividing, arc cutting, lead cutting etc. can be done very easily.
- **RS232C Interface is provided as standard.**
 Block data/ parameter data can be up loaded/down loaded through RS232C interface. Moreover when the direct angle command interface is used, all program and management can be done on M/C side.
- **Up Grade of Water Proof Characteristic EMC Assessment**
 The direct out type connection is applied for all models of CNC Rotary Table, EMC assessment is satisfied as the total system.
- **The Latest Designed Digital Servo System**
 Very excellent acceleration/deceleration characteristics, the powered up torque and the best suited servo parameter realize the high quality and long life.
 (M ZRN) after Power ON or after releasing the emergency stop condition is not necessary.*
- **Plenty of Optional Functions**
 Full Closed Loop, MPG, M Function (IN:5/OUT:5), External N Number Search, External Position Display, External Power ON/OFF, Pitch Error Compensation
- **More than 25,000 sets working in the field.**
 This fact ensures the highest reliability.

* : The operation to establish the coordinate system is required at once, when turning the POWER ON at first time just after connecting the cable.

☞ Please refer to **CNC ROTARY TABLE** Catalogue.

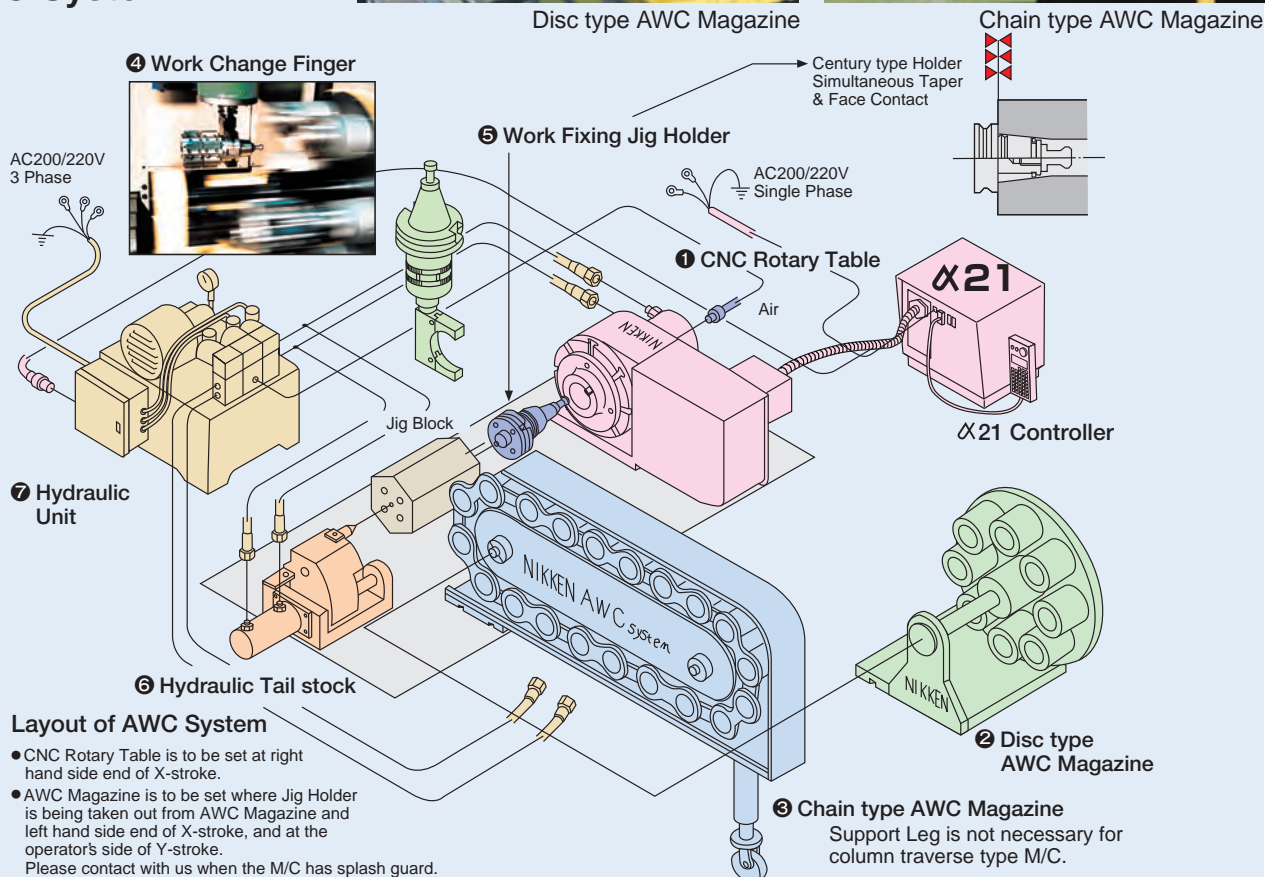


NEW

- X21 Controller**
- Standard (400W, 750W)
 300×280×285 10kg
Single Phase AC200~220V
 - Power Up (1,300W, 1,800W)
 540×340×400 28kg
3 Phase AC200~220V

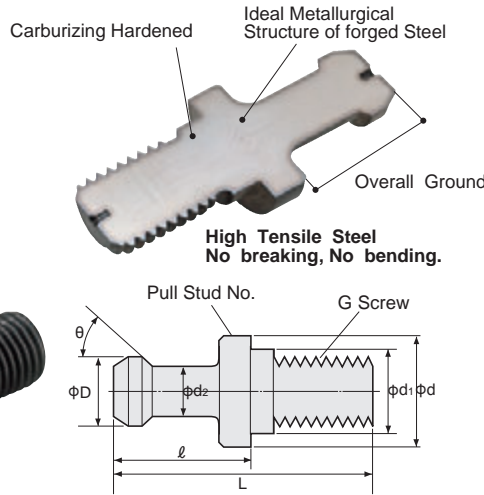


AWC System



- CNC Rotary Table is to be set at right hand side end of X-stroke.
- AWC Magazine is to be set where Jig Holder is being taken out from AWC Magazine and left hand side end of X-stroke, and at the operator's side of Y-stroke.
 Please contact with us when the M/C has splash guard.

PULL STUD



Pulling Force Measuring Tool



We would strongly recommend that a regular check on the pulling force of your M/C should be carried out to identify any problems at early stage. The NIKKEN Pulling Force Measuring Tool - CLP comes complete with 5m cable and the pulling force of your machine can be measured with the CLP using either a manual tool change or A.T.C.

PS

●PULL STUDS of new standard are also available.

Pull Stud No.	D	d	d1	d2	L	ℓ	G	θ°	Type	Remarks
PS- 1	15	23	17	10	60	35	M16	45°	BT40 MAS-1 Standard Type	MAS P40T-1
- 2								60°	BT40 MAS-2 Standard Type	MAS P40T-2
- 3	19	31	21	14	70	40	M20	45°	BT45 MAS-1 Standard Type	MAS P45T-1
- 4								60°	BT45 MAS-2 Standard Type	MAS P45T-2
- 5	23	38	25	17	85	45	M24	45°	BT50 MAS-1 Standard Type	MAS P50T-1
- 6								60°	BT50 MAS-2 Standard Type	MAS P50T-2
-16	11	16.5	12.5	7	43	23	M12	45°	BT30 MAS-1 Standard Type	MAS P30T-1
-17								60°	BT30 MAS-2 Standard Type	MAS P30T-2
-18	13	20	8.5	48	28	28	M12	45°	BT35 MAS-1 Standard Type	MAS P35T-1
-19								60°	BT35 MAS-2 Standard Type	MAS P35T-2
-5F	23	38	25	17	85	45	M24	45°	BT50 MAS-1	PS-5 Top face ground
-6F								60°	BT50 MAS-2	PS-6 Top face ground
-50	23	38	26.187	17	110	70	1-8UNC	45°	BT50	
-53									CAT50U	
-63	19	23	26	14	60	35	M16	60°	1-8UNC	CAT50U
-70										
-72	15	23	16.281	10	57.15	32.15	5/8-11UNC	45°		BT40
-O	23	38	25	17	85	45	M24			CAT40U
-O8-1	15	23	17	10	60	35	M16			BT50-90° Type
-P	24	36	25	18	71	31	M24	90°		BT40-90° Type
-P5-1	15	23	17	10	50	25	M16			BT50 MITSUI SEIKI
-P10	11	16	12.5	7	40	20	M12			BT40 MITSUI SEIKI
-U2	13.7	20	13	8.9	53	28	M12	60°		BT30 MITSUI SEIKI
-G4	23	38	25	17	85	45	M24			BT35 MATSUURA
-G5	15	23	17	10	54.6	29.6	M16	90°		BT50 MAZAK
-G45	28.956	37	25	20.828	65.2	25.2	M24			BT40 MAZAK
-G58	18.796	22	17	12.446	44.1	19.106	M16	45°		BT50 MAZAK Top face ground PS-G41 w/o hole
-G60	18.796	21.8	16.281	12.446	41.256	16.256	5/8-11UNC			BT40 MAZAK Top face ground PS-G51 w/o hole
-O19	23	38	—	17	85	45.2	1-8UNC			CAT40U OKUMA
-O47-2								90°		CAT50U
-P13	24	36	—	18	71	31	1-8UNC			IT50 MORI SEIKI
-H30	15	23	16.281	10	57.2	32.2	5/8-11UNC	45°		CAT50U MITSUI SEIKI
-B1	22	38	25	16	112	72	M24	60°		CAT40U HITACHI SEIKI
-809	28			21	74	34			BT50 OKUMA	
-805	19	23	17	14	54	29	M16	75°		BT50 Top face ground JIS-B6339-89
-801	12	16.5	12.5	8	43	23.4	M12			BT40 Top face ground JIS-B6339-89
-J	14	20	13	45	23			90°		BT30 Top face ground JIS-B6339-89
-M10	14	16	12.5	10	40	22	M12			BT35 KITAMURA
-R3	10	18	13	7	43	25		45°		CAT30S MAKINO SEIKI
-C	21	39	25	15	105.1	63.1	M24			BT35 ROKU-ROKU
-301	15	23	17	11	60	35	M16	60°		BT50 HITACHI SEIKO
-Q3	16	16.5	12.5	12.5	31.8	11.8	M12	45°		BT40 TSUGAMI
-BR*1	7	10	6.5	4	28	17	M 6	45°		BT30 OKADA
-81	12	16.5	12.5	8	44	24	M12	R4		BT15 BROTHER
-581	28	36	25	21	74	34	M24			BT30 CKD
-302	19	23	17	14	54	26	M16	75°		IT50
-122	13	17	13	9	44	24	M12			IT40
-S27	18.95	22.5	17	12.95	44.25	19.25	M16	45°		IT30
										BT40 SNK

★When Pull Stud w/o hole is used on Centre Through Coolant M/C, please use the Pull Stud which Top Face is ground.
★*1 The monoblock style of BT15 Slim Chuck with PS-BR is recommended.

PULL STUD with ID

Please add the abbreviation of ID maker on to the PULL STUD No. e.g. PS-6-IDB



- OMRON V600-D23P53 (φ8×6) : -IDM
- V600-D23P54 (φ12×5) : -IDN
- BALLUFF BIS-C122-04 (φ10×4.5) : -IDU
- BIS-C105-05 (φ12×6) : -IDB
- JAPAN ID SYSTEM WDD12B (φ12×6) : -IDQ

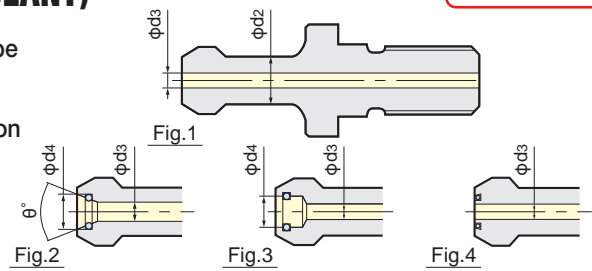
PULL STUD (CENTRE THROUGH COOLANT)

NIKKEN



The specification of the pull stud may be different depending on the machine specification and the machine serial number. Please confirm the specification of your machine and order the proper pull stud.

PS
(Centre Through Coolant)



Pull Stud	Specification	Machine Maker	φd ₃	FIG	Remarks
PS-130E	BT30 MAS- II Special	BROTHER, TOYOSK	2.5	1	φd ₂ =7.5
-132	BT30 MAS- I Special	FANUC	4	1	φd ₂ =8
-802	BT30 JIS-B6339-89		4	1	PS-801 with hole
-876	BT30 JIS	MAZAK	2.5	2	φd ₄ =5.5 θ=30°
PS-73*1			4	1	PS-1 with hole
-371	BT40 MAS- I	OKUMA HOWA	3	2	φd ₄ =7 θ=30°
-392		JTEKT	3	3	φd ₄ =7.3
-H28		HITACHI	3	3	φd ₄ =5
-75*1	BT40 MAS- II		4	1	PS-2 with hole
-806-1			6	1	PS-805 with φ6 hole
-813-1		MAKINO	6	1	AS568-015 with O-ring
-854	BT40 JIS	YASDA	6	1	φ3 with air hole
-874			6	2	φd ₄ =10 θ=30°
-877		JTEKT	3	3	φd ₄ =7.3
-B62-1		OKUMA	4	1	With O-ring S15
-366E-1	BT40 Centre Through	MORI SEIKI	7	2	φd ₄ =10 θ=30° N29104 * ³
-G51	BT40 ANSI	MAZAK	7	1	PS-G58 with hole 34931900680 * ²
-G510			7	3	PS-G51 High pressure 34261910160 * ²
-309	IT40 DIN		7	1	DIN 69872-A-1988
-380E	IT40 DIN Centre Through	MORI SEIKI	7	2	φd ₄ =10 θ=30° N29106 * ³
-A1	IT40 ISO A		7	1	ISO-7388/2-1984A
-A4	IT40 ISO B		7.35	1	ISO-7388/2-1984B
-G52	IT40 ANSI	MAZAK	7	1	34931900660 * ²
-G53		MAZAK	7	1	34931900670 * ²
-B64-1	CAT40U ANSI	OKUMA	4	1	With O-ring S15
-D72			7	1	ANSI/ASME B5,50-1985
-381E	CAT40U Centre Through	MORI SEIKI	7	2	φd ₄ =10 θ=30° N29105 * ³
PS-5E	BT50 MAS- I		6	1	PS-5 with hole
-552		JTEKT	6	3	φd ₄ =10.4
-563		YASDA, KOMATSU NTC	5.5	2	φd ₄ =11.2 θ=60° * ⁴
-595	BT50 MAS- I	MORI SEIKI	8	2	φd ₄ =11 θ=30° N29120 * ³
-5024		OKUMA HOWA	6	2	φd ₄ =9.5 θ=30°
-5027		OKK	6	4	With O-ring S9 at Face
-5030G		TOSHIBA	4.5	1	With O-ring P21
-M16		MAKINO	6	1	With O-ring P21
-H38-B		HITACHI	3	4	With O-ring S5 at Face
PS-6E		BT50 MAS- II		6	1
-578		JTEKT	6	3	φd ₄ =10.4
-579		YASDA	5.5	2	φd ₄ =11.2 θ=60° * ⁴
-596	BT50 MAS- II	MORI SEIKI	8	2	φd ₄ =11 θ=30° N29126 * ³
-5016		OKUMA HOWA	6	2	φd ₄ =9.5 θ=30°
-B60		OKUMA	6	1	With O-ring P21
-H39-B		HITACHI	3	4	With O-ring S5 at Face
PS-O31	BT50 90°		6	1	PS-O with hole
-O56		MORI SEIKI	8	2	φd ₄ =11 θ=30° N29119 * ³
-O67	BT50 90°	OKK	6	4	With O-ring S9 at Face
-O48-B		HITACHI	3	4	With O-ring S5 at Face
PS-810	BT50 JIS-B6339-89		10	1	PS-809 with hole
-819		JTEKT	6	3	φd ₄ =10.4
-833	BT50 JIS	YASDA	5.5	2	φd ₄ =11.2 θ=60° * ⁴
-816-1		MAKINO	6	1	With O-ring P21
PS-P16	BT50 MITSUI	MITSUI	8	1	PS-P with hole, Top surface ground
PS-G41			10	4	With O-ring P12 at Face 44831901160 * ²
-G63	BT50 ANSI	MAZAK	10	1	PS-G45 with hole, Top surface ground 32551901720 * ²
-G410			10	3	PS-G41 High pressure 34341901620 * ²
-D92	CAT50U ANSI		11.7	1	ANSI/ASME B5,50-1985
PS-A3	IT50 ISO A		11.5	1	ISO-7388/2-1984A
-A6	IT50 ISO B		11.55	1	ISO-7388/2-1984B
-512	IT50 DIN		11.5	1	DIN 69872-A-1988

*When pull stud without hole is used on the M/C with the centre through tool coolant, please use the pull stud which top surface is ground.

*JIS40 type pull stud (φd₂=14) is recommended for the machine with the centre through tool coolant instead of MAS40 type pull stud marked *1 (φd₂=10).

* *2 shows the pull stud Code No. of MAZAK. *The top surface of the pull stud of Fig.2 is not ground. * *3 shows the pull stud Code No. of MORI SEIKI. * *4 φd₃=φ7 is also available.

PULL STUDS CODE NO.



□ :NC5 Spindle Available

Machine Maker	Machine Model	TAPER	Holder	Code No.
IKEGAI	TV4, 4F, 4L	No.40	BT40	PS-1
	TV-U4, 4LII H4 TH500 THU500	40	40	-805
	TV5, U5 MXseries BX110Pseries BX130Pseries TH600 THU600 AH6, 8	50	50	-5
EGURO	E-32V	No.30	BT30	PS-16
	REVOLVER-32	30	NC5-46 Special	-837
	E-43V	40	BT40	-805
ENSHU	APORO4	40	NC5-63	-834-1
	S300 SS300 DT CENTERseries JE30S ES400	No.30	BT30	PS-16
	E-130 JE130 JE30S JE30G ES400 EV360, 360T	30	30	-17
	Super400, 450FV VMCseries HMCseries	40	40	-1
	JEseries ES450, 450T EV450, 530S GE460H, 480H	40	40	-2
	JE50	40	NC5-63	-N63AE
	EV650, 600MV VMCseries HMCseries VE65E	50	BT50	-5
OKUMA	JE80, 80G EV530 GE580, 590H	50	50	-6
	MA, MB, MC, MD, MF, MX-Aseries VH-40 VR-40 MU-400VA, 500VA MA-400HA GENOSseries	No.40	BT40	PS-2
	Centre Through(JIS)	40	40	-B62-1
	MX-55VA	40	NC5-63	-N63AE
	MA, MB, MC, MD, MX-B, MCV-A, B, MCRseries MCM-B	50	BT50	-6
OKUMA HOWA	Centre Through	50	50	-B60
	MILLAC Vseries, Hseries MM-300 ML-300	No.40	BT40	PS-1
	Centre Through	40	40	-371
	MILLAC Vseries, Hseries VMP-10, 16 VTM-65, 100, 80YB	50	50	-6
	Centre Through	50	50	-5016
OKK	VTM-65, 100	50	NC5-100	-N100VE
	PM300, 350	No.30	BT30	PS-801
	PCV, TRC, VM, AMC, DGM, VP, GC, HMseries HP400 PG8 PM400III DV5, V1 VC400 VC-X350 GR400	40	40	-1
	MCV-350, 410/40 PCH-400, 500 HPV400 MPH-400	40	40	-08-1
	VM4, 5 PCV-40II PCV-55 VC8-Jr4, 5 HM 40 HC8-40 PM 400 PG 8	40	NC5-63	-N63VE
	KCV600/800 MCVseries VC8series HM 50, 63 MCH600 HC8-50, 63, 600	45	NC5-85	-N85VE
	MCV, MCH, MHA, KCV, ACM, DCM, VM, HMseries PCV-510, 620 HM50, 63, 80 GC600 DV5	50	BT50	-0
	PCV50, 55, 60	50	50	-5
	PM500II	50	NC5-100	-N100VE
OHTORI	OSH-54 OSVseries OSU-545 BMVII-85	No.40	BT40	PS-1
	FTV-500, 500HV	40	40	-805
	BMV-40NC(OP), 400NC(OP), 500LNC, 500ANC OSV-139 FTV-1200	50	50	-5
OM	OMC-40HS	No.40	BT40	PS-1
	OMC-50V, 50HS	50	50	-5
	TDC, Omega-M, VTlex-M, NeoXseries	50	50	-6
	Centre Through	50	50	-579
KITAMURA	Mycenter-0, 1X HX-250	No.30	BT30	PS-16
	Mycenter-1XiF, HX250iF	30	30	-801
	Mycenter-2X, 3X, 4X, 4, -H300, 400, 500, Mycenter-Supercell400	40	40	-805
	Centre Through	40	40	-806-1
	Mytrunnion-3	40	40	-881
	Mycenter-5, 7X HX-500, 630, 800 Bridgecenter-8, 10 JIGcenter-5	50	50	-809
	Centre Through	50	50	-810
KIRA	Mycenter-HX1000i, 1250i	50	50	-833
	VMC, HMC, Arik, KN, VTCseries PC-30E, 30F, 30H, 30W KPC30a, 30b HPC-30Vb PCV-30	No.30	BT30	PS-16
	VTC-30a	30	NC5-46	-N46AE
	KV, Arik, VTC, KNseries PC40G	40	BT40	-1
KIWA	Centre Through	40	40	-806
	KCW-5VR	No.30	BT30	PS-16
	Triple-V21i, V41 KNH-426 KH-41, 45 KCW-10V	40	40	-805
KURASHIKI	Centre Through	40	40	-806
	KV-500, 500H, 700	No.40	BT40	PS-1
	KVseries KMVseries KBTseries KHseries CMNseries KHM-125 KBM11X	50	50	-5
KOMATSU NTC	N, Zseries	No.30	BT30	PS-16
	TMC, NH, NV, H, N, Z, ZV, ZHseries	40	40	-1
	ZV5400 ZH4000, 5000(Centre Through)	40	40	-371
	TMC, CNC, N, ZVseries	50	50	-5
	ZV5500(Centre Through)	50	50	-563
SHIZUOKA	CM-210G, 350B CM300-A, 300-5A	No.30	BT30	PS-16
	Bseries CM-350	40	40	-08
	Bseries SMVseries	50	50	-0
SHIN NIPPON KOKI (SNK)	SUPER HIGH SPEED MACHINE CMV	No.30	NC5-46	PS-N46
	CMV-50, 70T	40	BT40	-2
	CMV, DC, ESP FSP, HF, HPS, PS, RBseries PC-55V EXI-70K	50	50	-6
	REBO FLAME MACHINE, RAIL MACHINEPV640J	50	NC5-100	-N100VE
JTEKT	PV640J	No.30	BT30	PS-16
	FV-45 FVN-40 PVseries FXN-50T, 60T FA45 JV5, 5G FH, FVseries PV640J e500H4, UX570	40	40	-1
	FH-40II	40	NC5-63	-N63AE
	FV, FVN, FHN, FXN, PV, BN, FH, FA, RB, SBseries SV-65 e500H5	50	BT50	-5
	DN-1V, 2V, 1H(Centre Through)	50	50	-52
SUGINO MACHINE	Self Centre V15, NSV15, VC15, H15, H15B	No.30	BT30	PS-17
	MAC-V1E, 430VP VP10	No.40	BT40	-1
TAKIZAWA	MAC-V40, 40B Y520	40	40	-805
	MAC-V40, 40B Y520(Centre Through)	40	40	-806-1
	MAC-V40	40	NC5-63	-N63VE
TSUGAMI	VMA3-III VMC3-III VML3-III VA31H, 32H	No.30	BT30	PS-16
	FMA3-III FMA5-III	40	40	-2
	VMA4-III	40	40	-1
	VMT4-III	40	40	-805
TOSHIBA	JRV400, 450 NX76B	No.40	BT40	PS-1
	BMC, BTD, BP, BMC, MPC, MPE, MPF, MPH, VMC, BF, BTU, NX, BTH, BSF, BTFseries	50	50	-5
	MF-2020 MP-2635(5A)	45	NC5-85	-N85VE
	NX-76 MGF-21130	50	NC5-100	-N100VE
	BTD-110R13U	50	NC5-100	-831

*This table shows the standard Pull Stud Code No. for the newest M/C. Please refer old NIKKEN catalogue for the Pull Stud of the old M/C.

*The Pull Stud Code No. depends on your M/C specification, therefore please check your M/C specification to select the proper Pull Stud.

PULL STUDS CODE NO.



□ :NC5 Spindle Available

Machine Maker	Machine Model	TAPER	Holder	Code No.
TOYO SEIKI	TVT, TVMC, THMC, TTC, DTRseries	No.30	BT30	PS-17
	Centre Through	30	30	-130E
	TVT 30SR TVMC 301 THMC 310 TVT310S TVT313M1.S, SL TVT302M1.S, L	30	NC5-46	-N46AE
	TVT 30SR Special TVMC 301 THMC 310 TVT310S TVT302M1.S, L	30	NC5-46	-N46E
NIIGATA	H-44, 45 THMC410 H-46	40	BT40	-1
	PN40, 40A SPN40 EF40H ENseries VNseries PNseries	No.40	BT40	PS-2
	HNseries BHNseries SPN50, 63 ULTY501, 701, 901 MPN-80	50	50	-6
	BFN-50, 63	40	NC5-63	-820-1
NISHIDA KIKAI	SBS-2	40	-63	-358
	HFA-3 VFR-3 HAS-3 HLA-3 HLB-3	No.30	BT30	PS-16
	HDB-3	30	NC5-46	-827
	HKD-3 HDB-3	30	-46	-N46E
	VS-4, HS-4C, 4M HT-4 HD-4 HW-4 HLE-4 HFA-4 HLB-4	40	BT40	-1
	HDC-4	40	NC5-63	-849
	HFB-4 HFC-4 HDC-4	40	-63	-N63AE
HASEGAWA	HS-5C, 5M, 5D HP-5A, 5B HFA-5 HLB-3	50	BT50	-6
	V3, V3-5AX	No.30	NC5-46	PS-N46AE
HAMAI	FZ-16, 16L, 16E, 26, 26L DZ-16, 16L, 16LA	No.30	BT30	PS-16
	MC-3VA, 3VS, 4VS EN-3, 4, 6 EN-40 HN-40	40	40	-1
	MC-50V, 70V, 80V, 6V, 5VA, 6VA, 8VA T-80MH, 180MH	50	50	-5
FANUC	ROBO DRILL/DRILL/DRILL MATEseries X-T14IA X-T21ID X-T21IE X-T21IF	No.30	BT30	PS-16
	Centre Through	30	30	-132
	X-T14IB X-T14IC X-T21ID X-T21IE X-T21IF	30	NC5-46	-123-AIR
	Centre Through	30	NC5-46	-123E
FUJI SEIKI	FMC-3V, 30V5, 35V5	No.40	BT40	PS-2
	Centre Through	40	40	-806-1
	FMC-6V, 6VR, VG, VP, 50HF, 300QT	50	50	-5
BROTHER	Centre Through	50	50	-526
	TC-201, 203, 203C, 20A	No.15	No.15	PS-BR
	TC-221, 225, 227, 229, 229N, 22A, 311, 312N, 31A, 321, 323, 324, 324N, 325, 32A, 32B, S2A, S2B, S2C, R2A, 22B, S2D, 32BN, 31B, R2B	30	30	-17
	Centre Through	30	30	-130E
	TC-22A, 32A, 32B	30	NC5-46	-N46AE
HORKOS	TC-731, 731S	40	BT40	-1
	HFN, HTNC, ESseries NJ50 RS50H PM70H RM70 ES50H ES50V-I	No.30	BT30	PS-16
	HFN, HTNC, RM, DM, HFNseries NS70 MOH630 THMC410	40	40	-1
	HFN-SAM40 HFN-SM30H RS50H	30	NC5-46	-N46E
	Centre Through	40	BT40	-73
HOWA	HFN, HTNCseries G50H C50H DM100H RM100H NM100 DM100H NM100	50	50	-5
	Centre Through	50	50	-5E
	MMN, MDT, MBN, MSN, MEN, MJN, MZN, MKNseries	No.30	BT30	PS-16
	MBN-350HX MXN-600-V CJ	30	NC5-46	-N46AE
HONDA ENGINEERING	MBN, MCN, MHNseries MCV-800	40	BT40	-1
	MBN-800 HS-500	50	50	-5
	SPOOL HOLE MACHINE	No.30	NC5-46 Special	PS-N46AE
	H-VS5000	30	NC5-46	-N46AE
HOMMA	H-VT6000 SHAFT END MACHINE	40	NC5-63	-N63AE
	H-CR462	40	NC5-63 Special	Special
	NN-S HB-LB461	50	NC5-100	PS-N100VE
MAKINO	FM-15/40B, 20/50B, 25/50B, 30/60B TAC-8M, 12M, 16M, 20M, 25M, 30M STAC-12M, 16M, 20M, 25M	No.50	BT50	PS-5
	a1, A, Vseries J55, 88	No.40	BT40	PS-805
	Centre Through	40	40	-813-1
	BNCseries FNCseries MCseries SF64 A55, 66, 88	40	40	-1
	a1, A, V, GFseries	50	50	-809
MAKINO SEIKI	Centre Through	50	50	-816-1
	FDNCseries GN1712-A GFseries FNCseries MCseries a71, 81 A77, 88, 99, 100 V77	50	50	-5
	MSA30, 40, 50 MS5A, 5B MSX30 PS1-W MSJ25 MSJX25 MSB58, 512, 516	No.30	BT30	PS-16
	MSA30, 40, 50 MS5A, 5B MSX30 MSB58, 512, 516, S5B	40	40	-1
MATSUURA	MSA30, 40, 50 MSB58	40	NC5-63	-N63VE
	Centre Through	40	BT40	-73
	//MASTER, 400V-24, FX-1	No.30	BT-30	PS-17
	VX-0, -1 FX-0, 1G, 2 LX-0	30	30	-801
	MC, RA, MAM, FXM, FX, H, Max, V, Max, H, Plus, R, Plus, V, Plusseries Mold Plus800	40	40	-805
	MC-600VG, 600VDC RA-4G MAM-500HF	40	NC5-63	-N63AE
	MCseries RAseries MAMseries	40	NC5-63	-N63VE
	Centre Through	40	BT40	-806-1
	MC-1000V, 1250 V, 1500V, 2000V MC900H, 900HG H.Plusseries	50	50	-6
	RA-4G(#50) MC-1500VG(#50) MC-900HG LX-1500	50	50	-809
MITSUI SEIKI	VS, HR, HT, HUseries VT3A VU50A	No.40	BT40	PS-P5-1
	Vertexseries	40	40	-805
	Centre Through	40	40	-813-E5
	VU, VJ, VS, H, HU, HS, HR, HPTseries	50	50	-P
MITSUBISHI	Centre Through	50	50	-P16
	V-360 M-V4C, V5C M-H4B, H5B MPAseries M-Vseries M-Hseries	No.40	BT40	PS-1
	V, M-V, M-H, M-VS, MPA, MAF, MVR, MHT, MKH, DHSeries	50	50	-6
MECTRON (MIYANO)	Centre Through	50	50	-6E
	MAF	50	NC5-100	-N100VE
MORI SEIKI	MSV, MTV-C, , MTV-T, MTS, TSVseries MCH-80	No.30	BT30	PS-17
	MSV, MTV-C, MTV-T, TSVseries	40	40	-2
	Centre Through	No.30	BT30	PS-16
	TV-300, 400 ACCUMILL4000 ULTIMILL H3000, V3000	30	30	-114
	Centre Through	40	40	-O8-1
	SV, SH, SLV, MV, MH, NV, NMV, NVD, NH, AFM, Dura Vertical, NVX, NHX, VSseries Super TILT500 SVL5000, 5250	40	40	-366E-1
	Centre Through	40	40	-N63AE
	SV400	40	NC5-63	-N63AE
	SV500 SH50 SH500	40	NC5-63	-N63VE
	SV, SH, MV, MH, MB, NV, NH, NVX, NHX, VS, NMH, NMVseries	50	BT50	-0
MV1003	50	NC5-100	-N100VE	
MV65B/50	50	-100	-835	

*This table shows the standard Pull Stud Code No. for the newest M/C. Please refer old NIKKEN catalogue for the Pull Stud of the old M/C.
 *The Pull Stud Code No. depends on your M/C specification, therefore please check your M/C specification to select the proper Pull Stud.

PULL STUDS CODE NO.



□:NC5 Spindle Available

Machine Maker	Machine Model	TAPER	Holder	Code No.
MORI SEIKI	VKseries VM-40, 50 VS-40, 50, 60 VKCseries VAseries HG-400 HSseries HK-630 HAseries	No.40	BT40	PS-1
	VS-50, 60	40	NC5-63	-N63AE
	Centre Through	40	BT40	-H28
	VS-40, 50, 60, HG-800	45	NC5-85	-N85VE
	VK-45, 55, 65, 85 VAseries VGseries VFseries VS-50, 60 HSseries HK-630 HGseries HCseries	50	BT50	-0
	HS-630 HG-630 VF-23 VK-85	50	NC5-100	-N100
YAMAZAKI MAZAK	Centre Through	50	BT50	-048B
	IMPULSE30 TypeA, B, C UN-600V, 600H	No.30	BT30	PS-17
	VTC, V, VQC, AJV, FJV, FH, FF, VARIAXIS, NEXUS, INTEGREGX, VCN, HCN, PFH, μ series ANGULAX900	40	40	-G58*1
	FF-510, 660	40	NC5-63	-N63AE
	VTC, V, VQC, AJV, FJV, SV, H, FH, MTV, HV, INTEGREGX, VORIEK, VARIAXIS, VCN, HCN, VERSATECH, μ series	50	BT50	-G45*1
	H-12, 12N, 15, 20, 25 V12, 15, 20 VQC-10/15, 20/50	50	50	-G4
YASDA	YBM-55J, 640V, 850V, 8120V, 950V YPCseries VPCseries H30i H40	No.40	BT40	PS-1
	YBMV140	40	40	-805
	Centre Through	40	40	-854
	YBM-600N, 660N, 700N, 800N, 900N, 1000N, 120N, 100J, 1218V YMCseries	50	50	-5
	Centre Through	50	50	-563
	YBM-700N, YBM-120N	50	NC5-100	-N100VE
ROKU-ROKU	LIBERO RXseries	No.30	BT30	PS-16
	LIBERO RXseries	30	NC5-46	-110
	GIGA LIBERO RXseries	30	NC5-46	-N46E
	KX, MX, LX, GR-655N VERTIMACseries RMseries GIGA	40	BT40	-1

★This table shows the standard Pull Stud Code No. for the newest M/C. Please refer old NIKKEN catalogue for the Pull Stud of the old M/C.
 ★The Pull Stud Code No. depends on your M/C specification, therefore please check your M/C specification to select the proper Pull Stud.
 ★*1 Please order the pull stud Code No. of MAZAK P.224

TECHNICAL INFORMATION for STOPPER PIN



This is typical information (guide line) of the stopper pin only for the Spindle Speeder and Oil Hole Holder. Be careful that the dimension of the stopper pin for Angular Head is different from this. Please refer your M/C specification very carefully for more detail.

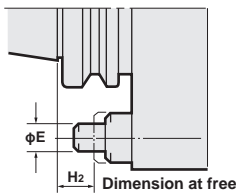


Fig.1

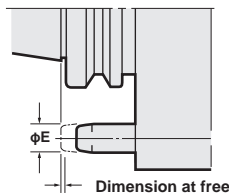
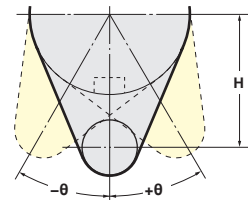


Fig.2



Machine Maker	Shank	H	E	H2	Fig.
ENSHU	BT30	50	12	4	1
	40	60	12	14	1
	50	82	18	22	1
OKUMA	BT40	65	18	0	2
	50	80	18	0	2
OKUMA HOWA	BT40	65	18	0	2
	50	80	18	11	2
OKK	BT40	65	12	16	1
	50	82	18	22	1
KITAMURA	BT40	65	18	0	2
	50	82	18	22	1
KURASHIKI	BT40	60	12	14	1
	50	145	18	0	2
SHIN NIPPON KOKI(SNK)	BT50	82	18	22	1
TOSHIBA	BT40	65	18	0	2
	50	145	24	24	2
JTEKT	BT40	65	18	0	2
	50	80	18	4	2
NIIGATA	BT40	65	18	0	2
	50	80	18	11	2

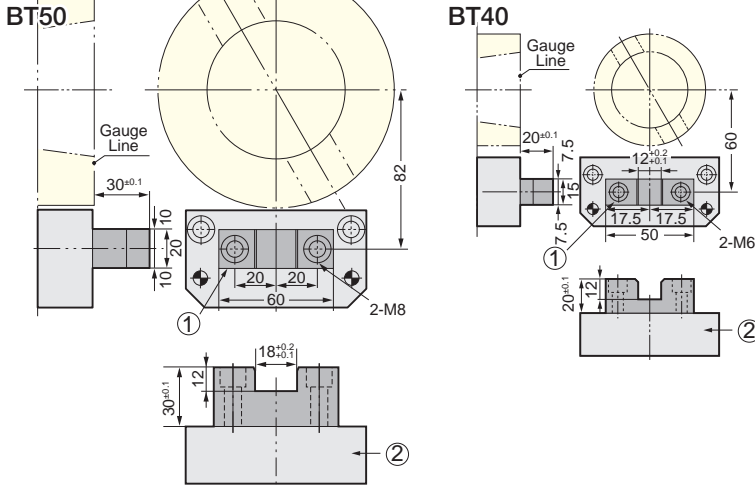
Machine Maker	Shank	H	E	H2	Fig.
MORI SEIKI (HITACHI SEIKI)	BT40	60	12	14	1
	50	82	18	22	1
BROTHER	BT30	40	12	12	1
	40	60	12	14	1
KIRA	BT30	55	12	-1	1
FANUC	BT30	55	12	29	1
MAKINO	BT40	65	18	2	2
	50	80	18	5	2
MATSUURA	BT40	60	12	28	1
	50	82	18	22	1
MITSUI SEIKI	BT40	60	12	14	1
	50	82	18	22	1
MITSUBISHI	BT40	65	18	0	2
	50	80	18	27.7	2
MORI SEIKI	BT40	65	18	4	2
	50	80	18	0	2
YAMAZAKI MAZAK	BT40	65	18	2	2
	50	80	18	0	2
ROKU-ROKU	BT40	65	18	9	2
YASDA	BT40	60	12	14	1
	50	82	18	22	1

TECHNICAL INFORMATION for STOPPER BLOCK



This is the information for the stopper block when **NIKKEN Standard Spindle Speeder, Oil Hole Holder and Angular Head** are used. Please be careful that the pitch between the spindle centre and the centre of the hole of the stopper block varies depending on your M/C specification. When the stopper block has been already installed on your M/C, **please specify the drawing of the spindle flange on your M/C**, when ordering of the Spindle Speeder, Oil Hole Holder and Angular Head etc.

For SPINDLE SPEEDER

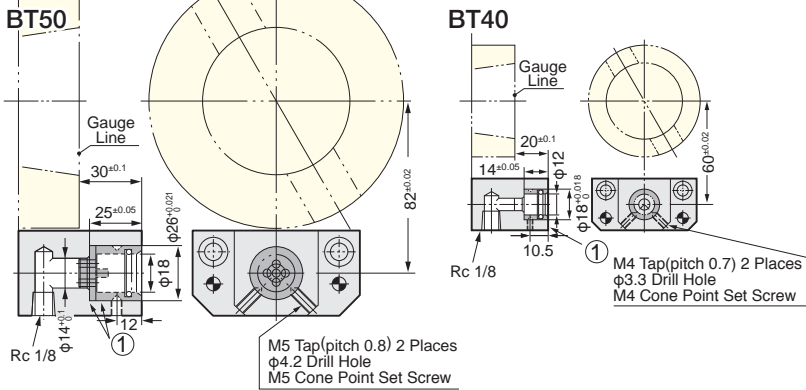


1. Please use **NIKKEN Original Stopper Block for Spindle Speeder** ① and make the **Stopper Block Base** ② by yourself.

Code No. of Stopper Block
 #40:NX40-STB
 #50:NX50-STB

2. How to make the Stopper Block Base
 - Make the suitable shape to meet with the tapped holes and the dowel pin holes on your M/C.
 - It's not necessary to be heat-treated.
3. The pitch between the spindle centre and the centre of stopper block has to be physically adjusted when the spindle speeder is clamped on the spindle.

For OIL HOLE HOLDER

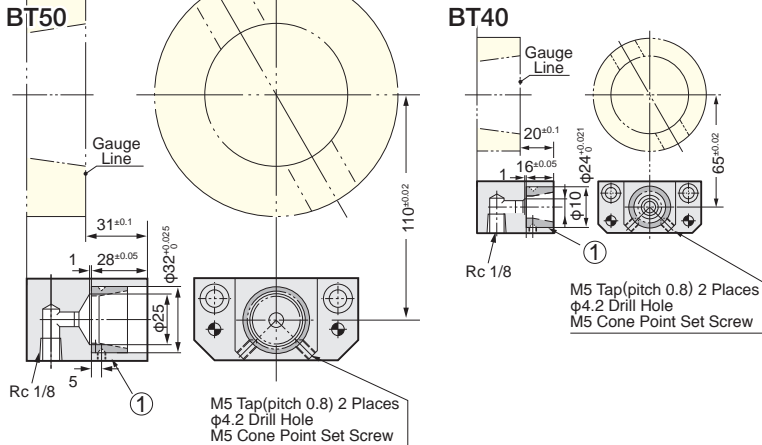


1. Please use **NIKKEN Bushing & Push Pin for the Oil Hole Holder** ① and make the Stopper Block by yourself.

Code No. of Bushing & Push Pin
 #40:BK40BS-A with O-ring P12
 #50:BK50BS-A & BK50PP-A with O-ring P18

2. How to make the Stopper Block.
 - Make the suitable shape to meet with the tapped holes and the dowel pin holes on your M/C.
 - It's not necessary to be heat-treated.
3. The pitch between the spindle centre and the centre of the hole of stopper block has to be physically adjusted when the oil hole holder is clamped on the spindle.

For ANGULAR HEAD

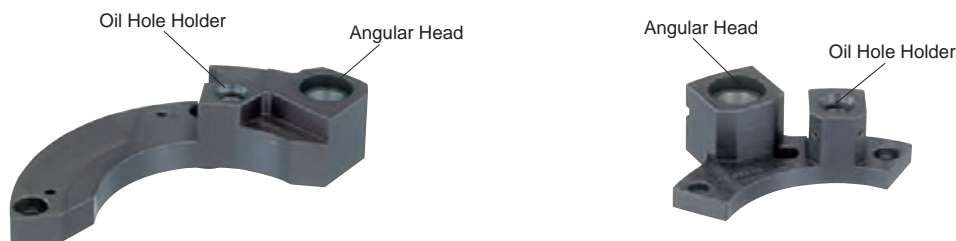


1. Please use **NIKKEN Bushing for the Angular Head** ① and make the Stopper Block by yourself.

Code No. of Bushing
 #40:AHA-03000-01
 #50:AHA-01000-02

2. How to make the Stopper Block
 - Make the suitable shape to meet with the tapped holes and the dowel pin holes on your M/C.
 - It's not necessary to be heat-treated.
3. The pitch between the spindle centre and the centre of the hole of stopper block has to be physically adjusted when the angular head is clamped on the spindle.

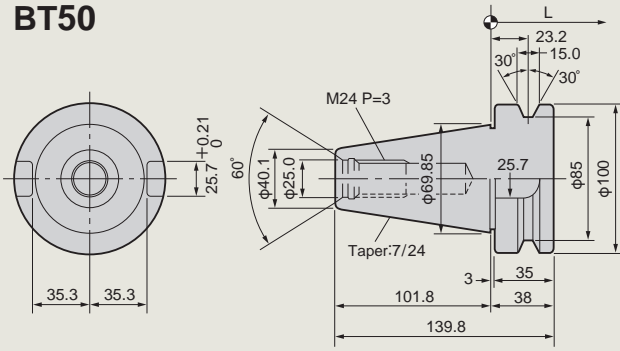
The combination stopper block is also available. Please specify the dimension when ordering.



DIMENSIONS of ISO, DIN & MAS BT SHANK

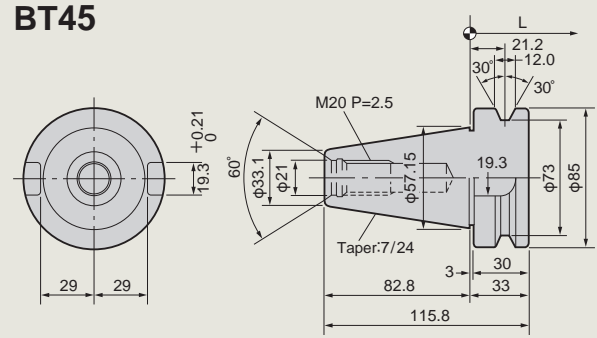


BT50



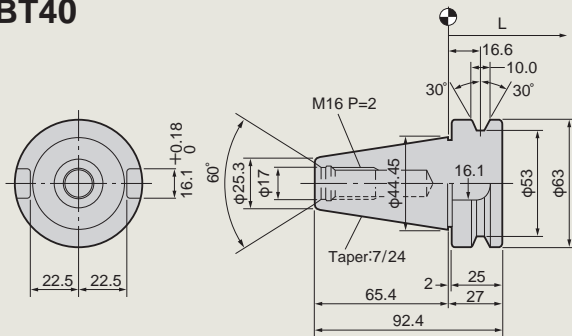
Pull Stud Code No. : PS-5, 6, 0, P, G41, G45, 50, 52

BT45



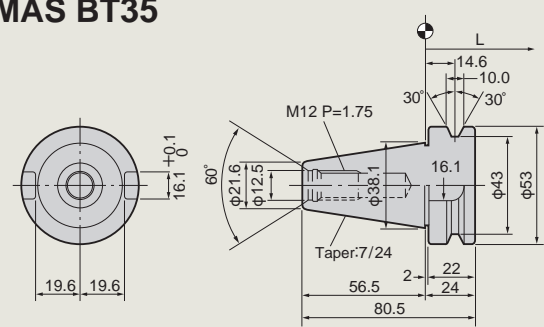
Pull Stud Code No. : PS-3, 4, 02, G1

BT40



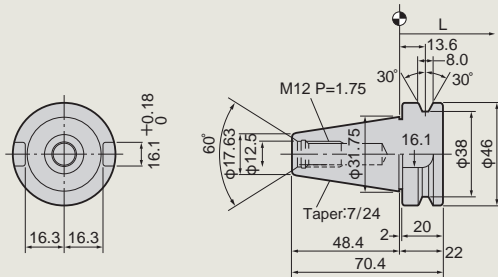
Pull Stud Code No. : PS-1, 2, 08, P5, G51, G58, G5, 301, 302

MAS BT35



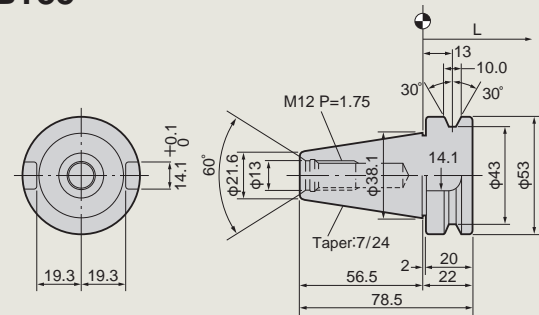
Pull Stud Code No. : PS-18, 19

BT30



Pull Stud Code No. : PS-16, 17, 81, P10

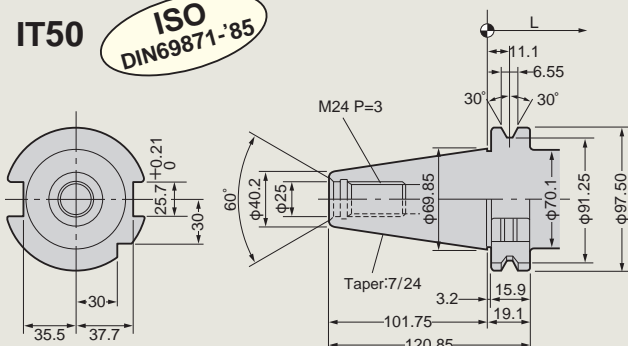
BT35



Pull Stud Code No. : PS-U2, J

IT50

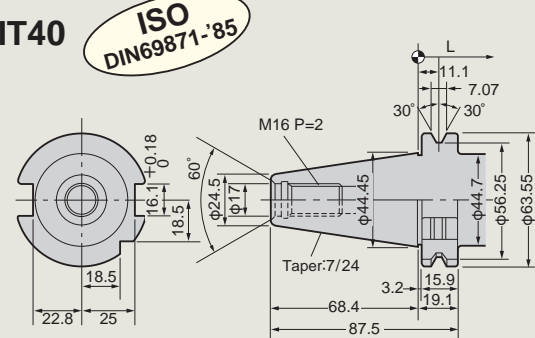
ISO
DIN69871-85



Pull Stud Code No. : PS-A3, A6, 512

IT40

ISO
DIN69871-85

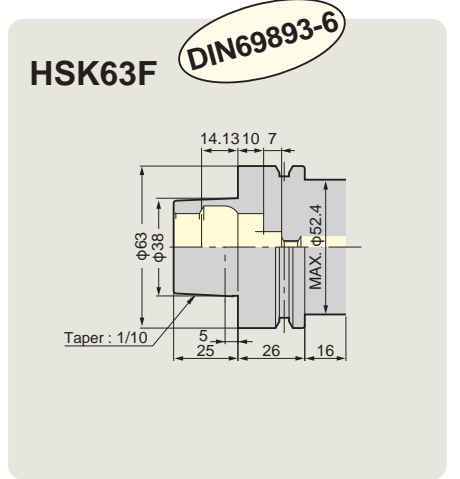
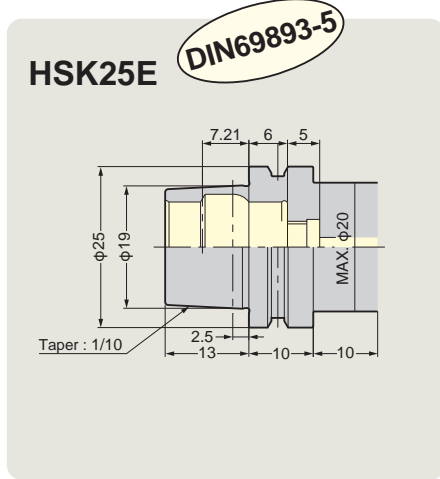
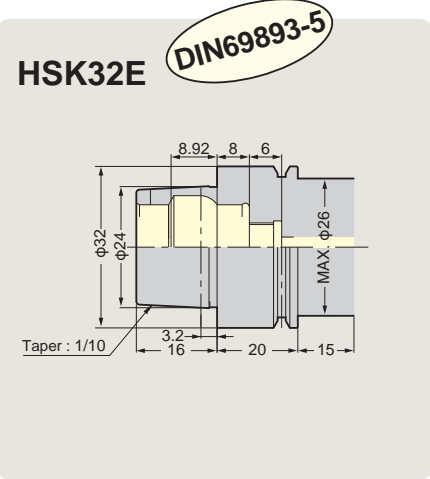
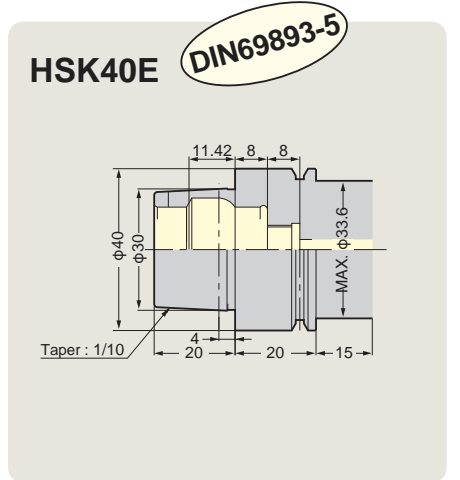
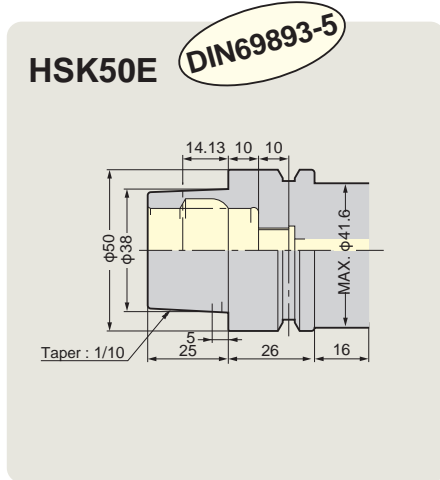
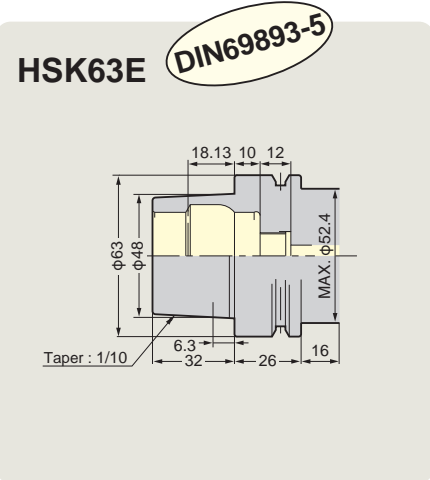
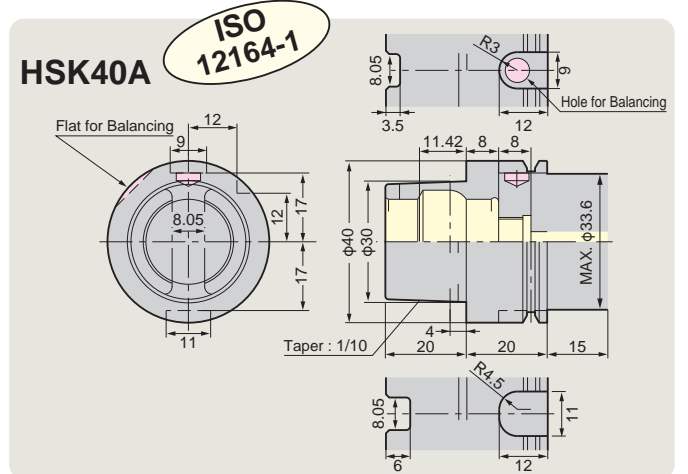
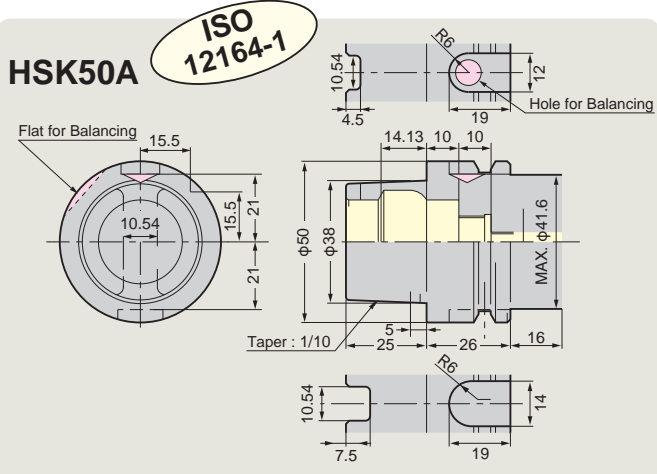
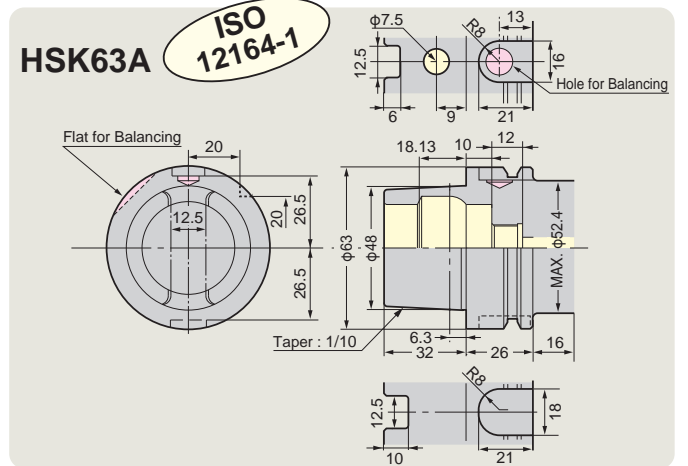
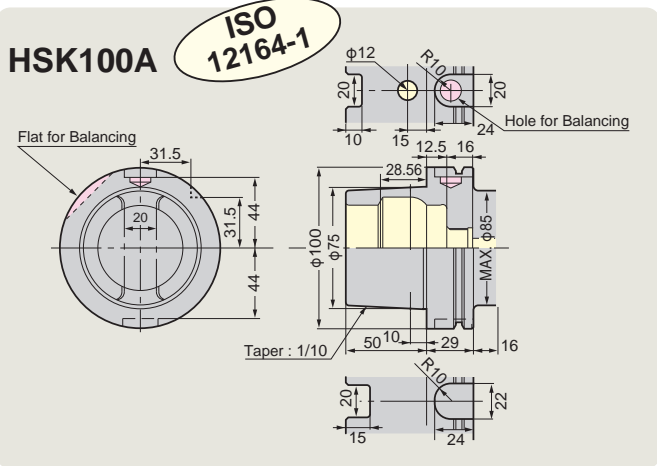


Pull Stud Code No. : PS-A1, A4, 319



For CAT Tooling, please refer to NC TOOLING SYSTEM Catalogue USA Version.

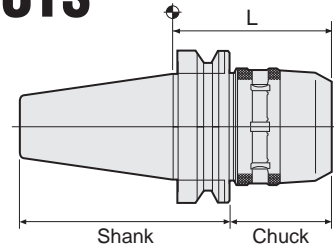
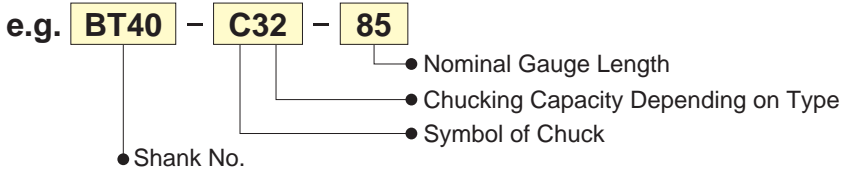
DIMENSION of ISO, DIN & HSK SHANK



NIKKEN HSK Tooling has a hole and a flat for mass balancing as standard. Hole for manual clamp and hole for ID are not standardized. Special HSK_A type which U grooves and drive key slots are symmetric design without V notch is also available. Please contact with us.

ALPHABETICAL INDEX OF THE PRODUCTS

Explanation of Code No.



BT/IT/CAT BT/IT standard P.267 CAT is USA standard.

Code No. "MBT□□" is **3LOCK Toolig** for BT. P.139

Code No. "NBT□□" is **2LOCK Toolig** for BT. P.158

Code No. "NC5-□□" is **NC5 Toolig**. P.193

Code No. "IT□□" is **IT Toolig**. P.123

Code No. "MIT□□" is **3LOCK Toolig** for IT. P.154

Code No. "NIT□□" is **2LOCK Toolig** for IT. P.185

Code No. "HSK□□" is **HSK Toolig**. P.208

When shank No. is **BT□□-**, please search by the symbol of chuck.

e.g. If Codo No. is **BT40-C32-85**, please refer **P.29** searched by **BT-C**.

BT/IT-C□□ MULTI LOCK MILLING CHUCK 29

When shank No. is started except **BT□□-**, please search by the shank No.

e.g. If Codo No. is **HSK63A-C32-115G**, please refer **P.209** searched by **HSK□□-C□□**.

HSK□□-C□-G HIGH SPEED MULTI LOCK MILLING CHUCK 209

FIGURES

1MP	INSERT TIP	98
3MS	INSERT TIP	98
3P	INSERT TIP	99
3MP	INSERT TIP	98
4MP	INSERT TIP	98
5P	INSERT TIP	99
5AX-	CNC ROTARY TABLE	257
6MP	INSERT TIP	98
7P	INSERT TIP	99
9A	SPARE part of CHAMFERING TOOL	
9CKR	COLLET REMOVAL for MILLING CHUCK	31
9CMD	PILOT DRILL for COMBAT Z DRILL	256
9CMT	INSERT TIP for COMBAT Z DRILL	256
9DKT	INSERT TIP for PRO-END MILL	103
9HC	SPANNER	43
9MC	STOPPER for MILLING CHUCK	105
9PEM	LOCK BOLT for PRO-END MILL	103
9TP	SPARE PART for TOUCH POINT	129
9ZFL	WRENCH for ZERO FIT HOLDER	120
9□□	SPARE PART Code No.	
10MP	INSERT TIP	98
10P	INSERT TIP	99
□S	TIP CLAMP HANDLE	92

A

A	CHAMFERING TOOL	
A21	ALPHA CONTROLLER CNC	260
A21PW	ALPHA CONTROLLER POWER UP	260
AB	BLADE of CHAMFERING TOOL	
AEG	INSERT TIP	66
BT/IT-AF□□	AUTOMATIC BACK SPOT FACING ARBOR	121
BT/IT-AFC□□	SOLID OFF-SET type ANGULAR HEAD	118
BT/IT-AFK□□	SOLID OFF-SET type ANGULAR HEAD	118
BT/IT-AFT□□	QUICK type OFF-SET ANGULAR HEAD	115
AHA	BUSHING for STOPPER BLOCK	266
BT/IT-AHC□□	SOLID type ANGULAR HEAD	118
BT/IT-AHK□□	SOLID type ANGULAR HEAD	118
AHK□□-□□	ADAPTER for QUICK type ANGULAR HEAD	116
BT/IT-AHM	MODULAR type ANGULAR HEAD	117
AHM□□-SK	MODULAR HEAD for ANGULAR HEAD	117
BT/IT-AHP□□	ANGULAR HEAD for DEEP HOLE	117
BT/IT-AHPX□□	HIGH SPEED type ANGULAR HEAD	114
BT/IT-AHT□□	QUICK CHANGE type ANGULAR HEAD	115
AL-□□	AIR LINE KID	113
AM□-□	CHAMFERING TOOL	
AS-□□	CHAMFERING TOOL	
AW□□-C□	AIR MASTER	
AWC	AWC SYSTEM	260
AWC-C□	CHAIN type AWC MAGAZINE	CNC
AWC-F□	FREE type AWC MAGAZINE	CNC

B

B□□	SPARE PART Code No. for BCB UNIT	85
BT/IT-BAC□□□	BALANCE CUT BAC BORING ARBOR for LARGE DIA.	79

BAL	BALL CENTRALIZER	132
□□-BCB□□	MICRO CUT BORING HEAD	88
BT/IT-BCB□□	MICRO CUT BORING HEAD for LARGE DIA.	80
BF	AUTOMATIC BACK SPOT FACING ARBOR	121
BK	BUSHING for STOPPER BLOCK	266
BM	BALANCE MASTER	
BT/IT-BOA□□	BORING BAR for CYLINDRICAL BORING TOOL	100
BRM	MORSE TAPER SHANK BROACH REAMER	250
BRS	STRAIGHT SHANK BROACH REAMER	250
BT/IT-BSA□□	BORING BAR for SQUARE BORING TOOL	100
BT/IT-BSB□□	BORING BAR for SQUARE BORING TOOL	100

C

BT/IT-C□□	MULTI-LOCK MILLING CHUCK	29
BT/IT-C□□C	MILLING CHUCK for CENTRE THROUGH	105
BT/IT-C□□CF	MILLING CHUCK for CENTRE/FLANGE THROUGH	105
BT/IT-C□□F	MILLING CHUCK for FLANGE THROUGH	107
CAF	CHAMFERING CUTTER for MODULAR type	88
CC□□-C□	INSERT TIP	98
CC□□-□□	CENTERING END MILL	
CCK□-□	CENTRE COOLANT COLLET	32
CKKL	SPANNER for FRONT NUT	32
CCNK□-□	CENTRE COOLANT COLLET	32
CCT	CENTERING TOOL	
CF-□□	HOBBING CHUCK	
CH	CIRCULAR HANDLE	
CKFN□-□	FRONT NUT	32
CKFN□-□C	FRONT NUT with O-RING	32
CKFN□-□D	FRONT NUT for direct chucking	32
CKFN□-□DC	FRONT NUT with O-ring for direct chucking	32
CKFN□-□MN	FRONT NUT with multi nozzles	32
BT/IT-CLE	SPINDLE TAPER CLEANER	153
BT/IT-CLEF	SPINDLE FLANGE CLEANER	153
CN	INSERT TIP	98
CP-□	CLAMP PIECE for BCB UNIT	94
CSM	SPARE PART Code No. for BORING HEAD	92
BT/IT-CZF	ZERO FIT type MILLING CHUCK	120

D

D□□-□	STRAIGHT SHANK DRILL CHUCK	
D□-J□	STRAIGHT SHANK DRILL CHUCK ARBOR	
D□□-NPU□□	STRAIGHT SHANK NC DRILL CHUCK	45
BT/IT-DAC□□□	DOUBLE CUT BORING ARBOR for LARGE DIA.	
BT/IT-DM□□	SIDE LOCK HOLDER for COMBINATION SHANK	46
BT/IT-DJ□□	DJ BORING HEAD	83
DSA□□-MT	DSA SOCKET	46
DT□□-NPU□□	QUICK CHANGE type NC DRILL CHUCK	
D.T□-□□	NON STOP D.T set	
DV	DIVIDING PLATE	

E

E236N	ECONOMY type PRESETTER	133
E238	PRESETTER	135
E450N	PRESETTER	136
EA□-□	CONVENTIONAL STUB ARBOR	

EP□□	PRESS FIT END MILL	
ET□□-□	QUICK CHANGE type STUB ARBOR	
ETS□-□	ETS COLLET	112
EXE□□	HEIDENHAIN EXE UNIT	CNC
F		
F□□-□	STRAIGHT SHANK FACE MILL ARBOR	
F□□-AHM□□	DIRECT MOUNT FLANGE type ANGULAR HEAD	119
FA□□-□	Conventional FACE MILL ARBOR	
FM□□	LOCK BOLT for FMA	101
FT□□-□	QUICK CHANGE type FACE MILL ARBOR	
BT/IT- FMA□□	FACE MILL ARBOR (JIS)	101
BT/IT- FMB□□	FACE MILL ARBOR	101
BT/IT- FMC□□	SHOULDER CUTTER ARBOR	102
CAT- FMD	SHOULDER CUTTER ARBOR	
FMM	MORSE TAPER SHANK MILL REAMER for Stepped Hole	248
FMS	STRAIGHT SHANK MILL REAMER for Stepped Hole	248
FW	DRIVE KEY for FMA	101
G		
G	MASTER GAUGE	137
G□-□	DISTANCE COLLAR	
GH	GH HANDLE	30
GH□-TLS	GH HANDLE with ADJUSTABLE TORQUE	30
GN	MASTER GAUGE	135
GN□-□	COLLAR for STUB ARBOR	104
GNT□	NUT for STUB ARBOR	104
BT/IT- GSK□□-P	HIGH SPEED SLIM CHUCK	
GSKN□	NUT for HIGH SPEED SLIM CHUCK	43
GSKN-□B	TiN BEARING NUT for HIGH SPEED SLIM CHUCK	43
GSKN-□BJ	J type TiN BEARING NUT for HIGH SPEED SLIM CHUCK	43
GSKN-□J	J type NUT for HIGH SPEED SLIM CHUCK	43
G-□	CARTRIDGE CLAMP BOLT for RAC UNIT	92
H		
H-□□	HYDRAULIC TAIL STOCK	CNC
HA□□-T□□	QUICK CHANGE HOLDER	
HMM	MORSE TAPER SHANK MILL REAMER for Through Hole	247
HMS	STRAIGHT SHANK MILL REAMER for Through Hole	247
HP	HEIGHT PRESETTER	131
HSK□□-□□	HSK TOOLING	208
HSK□□-BAC□□	BALANCE CUT BAC BORING ARBOR for LARGE DIA.	241
HSK□□-C□	MULTI-LOCK MILLING CHUCK	210
HSK□□-C□-G	HIGH SPEED MULTI-LOCK MILLING CHUCK	209
HSK□□-DJ□□	DJ BORING HEAD	244
HSK□□-CZF□□	ZERO FIT type MILLING CHUCK	221
HSK□□-FMA□□	FACE MILL ARBOR	225
HSK□□-FMC□□	FACE MILL ARBOR	225
HSK□□-FMH□□	FACE MILL ARBOR	226
HSK□□-GSK□□	HIGH SPEED SLIM CHUCK	
HSK□□-LP	LUBRICATION PIPE	222
HSK□□-MDMS□□	MAJOR DREAM SHRIBNK FIT HOLDER	220
HSK□□-MDPE□□	MAJOR DREAM PRO-ENDMILL	219
HSK□□-MDQ□□	MAJOR DREAM Style MODULAR type BORING BASE HOLDER	244
HSK□□-MDSK□□	MAJOR DREAM HOLDER	217
HSK□□-MTA□□	MORSE TAPER ADAPTER A type	225
HSK□□-MMC□	MINI-MINI CHUCK	218
HSK□□-NC5-	DREAM-CUT HOLDER	
HSK□□-NPU□□	NC DRILL CHUCK	223
HSK□□-Q□□	BASE HOLDER for MODULAR type	243
HSK□□-RAC□□	BALANCE CUT RAC BORING ARBOR	227
HSK□□-RAC□□□	BALANCE CUT RAC BORING ARBOR for LARGE DIA.	235
HSK□□-SCA□□	STUB ARBOR	224
HSK□□-SK□□	SLIM CHUCK	214
HSK□□-SK□□-P	HIGH SPEED SLIM CHUCK	213
HSK□□-SL□□	SIDE LOCK HOLDER	223
HSK□□-SMS□□	SHELL END MILL ARBOR	
HSK□□-SZF□□	ZERO FIT type SLIM CHUCK	221
HSK□□-TB□□	TEST BAR	222
HSK□□-VC□□	VC HOLDER	218
HSK□□-Z□□	TAPPER CHUCK	224
HSK□□-ZMAC□□	ZMAC BORING ARBOR	237
BT/IT- HTS	AIR TURBINE SPINDLE TOOL	112
I		
IT□□-□□	IT Tooling	123
IT□□-C□	MULTI-LOCK MILLING CHUCK	123
IT□□-CZF□□	ZERO FIT type MILLING CHUCK	126
IT□□-GSK□□	HIGH SPEED SLIM CHUCK	
IT□□-MDSK□□	MAJOR DREAM HOLDER	125
IT□□-MMC□□	MINI-MINI CHUCK	124
IT□□-NC5-	DREAM-CUT HOLDER	

IT□□-SK□	SLIM CHUCK	124
IT□□-SK□-P	HIGH SPEED SLIM CHUCK	124
IT□□-SZF□□	ZERO FIT type SLIM CHUCK	126
IT□□-VC□□	VC HOLDER	125
J		
J	JIG PLATE	
J□-□	DJ BORING BIT	84
BT/IT- JTA□□	JACOBS TAPER ADAPTER	45
K		
K-□	AIR LINE KID	113
K□□-BCB	STRAIGHT SHANK MICRO CUT BORING BAR	91
K□□-DJ	STRAIGHT SHANK DJ BORING BAR	91
K□□-MMC	STRAIGHT SHANK MINI-MINI CHUCK	33
K□□-MMP	STRAIGHT SHANK MINI-MINI CHUCK	33
K□□-MT	STRAIGHT SHANK MORSE TAPER SOCKET	47
K□□-Q	STRAIGHT SHANK BASE HOLDER for MODULAR type	87
K□□-RAC	STRAIGHT SHANK BALANCE CUT BORING BAR	89
K□□-SCA	STRAIGHT SHANK STUB ARBOR	104
K□□-SCC	STRAIGHT SHANK STUB ARBOR	104
K□□-SK	STRAIGHT SHANK SLIM CHUCK	40
K□□-ZMAC	STRAIGHT SHANK ZMAC BORING BAR	89
KM□-□	STRAIGHT COLLET	31
L		
LC	HOLDER for LIVE CENTRE	
LCD	CENTRALIZING DIAL GAUGE	
LCH□□-SK□□	CENTERING HOLDER	
LE□□-MT□□	OIL JETTER DRILL SLEEVE for MT SHANK	
LEA□□-□	OIL JETTER BITE SLEEVE	
LH	HOLDER for LIVE CENTRE	
LK-□	COLLET for LIVE CENTRE	
LM	HOLDER for LIVE CENTRE	
LM□-□	LIVE CENTRE	
LMA	LEAD MASTER	
LNC-□	BORING BITE BIT	
LNT-□	BORING BITE BIT	
LQ□-□	CENTRE DRILL for LIVE CENTRE	
LS□□-□□	OIL JETTER DRILL SLEEVE for STRAIGHT SHANK	
LSC-□	OIL JETTER BITE BIT	
LST-□	OIL JETTER BITE BIT	
M		
M□□	SPAIR PART	
M□-□	BCB MICRO UNIT	94
M□A(B, C)-□	DAC UNIT	
M□-□C	BCB CARTRIDGE	94
M□H-□	MAC UNIT	
M□HZ-□	ZMAC UNIT	93
M□HZ-□C	ZMAC CARTRIDGE	93
MA	HORIZONTAL MILLING CUTTER ARBOR	
MBT□□-□□	3 Lock Tooling for BT	139
MBT□□-BAC□□	BALANCE CUT BAC BORING ARBOR for LARGE DIA.	150
MBT□□-BLK□□	BLANK ARBOR	149
MBT□□-C□	MULTI-LOCK MILLING CHUCK	141
MBT□□-C□-G	HIGH SPEED MULTI-LOCK MILLING CHUCK	141
MBT□□-CLEF	FLANGE CLEANER	152
MBT□□-CZF□□	ZERO FIT type MILLING CHUCK	152
MBT□□-DJ□□	DJ BORING HEAD	149
MBT□□-FMA□□	FACE MILL ARBOR (JIS)	151
MBT□□-FMC□□	SHOULDER CUTTER ARBOR	151
MBT□□-GSK□□	HIGH SPEED SLIM CHUCK	
MBT□□-MMC□	MINI-MINI CHUCK	146
MBT□□-PFL□	PFL MASTER HOLDER	
MBT□□-Q□□	BASE HOLDER for MODULAR type	149
MBT□□-RAC□□	BALANMER CUT RAC BORING BAR	149
MBT□□-RAC□□□	BALANCE CUT RAC BORING ARBOR for LARGE DIA.	150
MBT□□-SK□□	SLIM CHUCK	149
MBT□□-SZF□□	ZERO FIT type SLIM CHUCK	152
MBT□□-VC□□	VC HOLDER	146
MBT□□-ZMAC□□	ZMAC BORING BAR	147
MCA□□F-□□	NATIONAL TAPER MILLING CHUCK	
MCCZ	ZMAC CARTRIDGE of BALANCE CUT BORING BAR for LARGE DIA.	81
MCC-B	BALANCER HEAD of BALANCE CUT BORING BAR for LARGE DIA.	81
MCG□□	STOPPER for MILLING CHUCK	195
MCM□-□	MORSE TAPERÄiTANGÄjMILLING CHUCK	
MCM□T-□	MORSE TAPERÄiDRAWINGÄjMILLING CHUCK	
MCT□-□	QUICK CHANGE type MILLING CHUCK	
MDSKN-□B	TiN BEARING NUT for MDSK	43
MDSKN-□BJ	J type TiN BEARING NUT for MDSK	43
BT/IT- MHD□□	MULTI DRILL HEAD	119

BT/IT- MHS□□	MULTI DRILL HEAD	119
BT/IT- MHT□□	MULTI TAPPER	119
BT/IT- MHV□□	HIGH SPEED MULTI DRILL HEAD	119
MIT□□-□□	3 Lock Tooling for IT	154
MIT□□-C□□	MULTI-LOCK MILLING CHUCK	154
MIT□□-FMA□□	FACE MILL ARBOR	157
MIT□□-FMH□□	FACE MILL ARBOR	157
MIT□□-GSK□□	HIGH SPEED SLIM CHUCK	
MIT□□-MMC	MINI-MINI CHUCK	155
MIT□□-SK□□	SLIM CHUCK	155
MIT□□-VC□□	VC HOLDER	156
MM□□-□□	MULTI TAP HEAD	
BT- MMC□□	MINI-MINI CHUCK	33
BT- MMC□□C	MINI-MINI CHUCK for CENTRE THROUGH	106
BT- MMC□□F	MINI-MINI CHUCK for FLANGE THROUGH	108
MMCL	WRENCH for MINI-MINI CHUCK	33
BT/IT- MOC□□	MILLING CHUCK type MULTI OIL HOLE HOLDER	109
BT/IT- MOK□□	SLIM CHUCK type MULTI OIL HOLE HOLDER	109
BT/IT- MOL□□	SIDE LOCK type MULTI OIL HOLE HOLDER	110
BT/IT- MOM□	MORSE TAPER type MULTI OIL HOLE HOLDER	110
BT/IT- MOQ□	MODULAR type MULTI OIL HOLE HOLDER	
MPK□□-□	COLLET for MINI-MINI CHUCK	33
MS□□-□	COLLET for MINI-MINI CHUCK	33
MS□□-A□	MASAMUNE SHRINK TOOL	172
MT□-UMT	MORSE TAPER SHANK UNIVERSAL MICRO TOUCH	127
MT□-UMTX	MORSE TAPER SHANK UNIVERSAL MICRO TOUCH	128
MT□T-DJ□	MORSE TAPER SHANK DJ BORING HEAD	
MT□T-Q□	MORSE TAPER SHANK BASE HOLDER	
MT□T-RAC□	MORSE TAPER SHANK BALANCE CUT RAC BORING ARBOR	
MT□T-ZMAC□	MORSE TAPER SHANK ZMAC BORING ARBOR	
BT/IT- MTA□□	MORSE TAPER ADAPTER A type	47
BT/IT- MTB□□	MORSE TAPER ADAPTER B type	48
MTO	MORSE TAPER SLEEVE for OIL HOLE HOLDER	110
MX	MORSE TAPER SHANK CARBIDE BROACH REAMER	251
N		
N□□-MT□	NON STOP type TAPER ADAPTER	
N□□-NPU□	NON STOP type NC DRILL CHUCK	
NBH-□□	AIR HYDRAULIC UNIT	CNC
NBT-□□-□□	2 Lock Tooling for BT	158
NBT□□-AH□□	ANGULAR HEAD	185
NBT□□-BAC□□	BALANCE CUT BAC BORING ARBOR for LARGE DIA.	180
NBT□□-C□□	MILLING CHUCK	159
NBT□□-C□□-G	HIGH SPEED MILLING CHUCK	160
NBT□□-CZF□□	ZERO FIT type MILLING CHUCK	173
NBT□□-DJ□□	DJ BORING HEAD	179
NBT□□-FMA□□	FACE MILL ARBOR	181
NBT□□-GSK□□-P	MAJOR DREAM SHRINK FIT HOLDER	172
NBT□□-MDMS□□	MAJOR DREAM PRO-ENDMILL	171
NBT□□-MDPE□□	MAJOR DREAM Style MODULAR type BORING BASE HOLDER	178
NBT□□-MDQ□□	MAJOR DREAM HOLDER	169
NBT□□-MDSK□□	MAJOR DREAM HOLDER	169
NBT□□-MMC□□	MINI MINI CHUCK	162
NBT□□-MTA□	MORSE TAPER ADAPTER A type	175
NBT□□-MTB□	MORSE TAPER ADAPTER B type	175
NBT□□-NPU□	DRILL CHUCK	174
NBT□□-NX□	SPINDLE SPEEDER	184
NBT□□-Q□□	MODULAR type BORING BASE HOLDER	169
NBT□□-RAC□□	BALANCE CUT RAC BORING ARBOR	178
NBT□□-RAC□□	BALANCE-CUT RAC BORING ARBOR for LARGE DIA.	180
NBT□□-SCA□□	STUB ARBOR	183
NBT□□-SK□□	SLIM CHUCK	163
NBT□□-SK□□-P	HIGH SPEED SLIM CHUCK	166
NBT□□-SKT□□-P	HIGH SPEED SLIM CHUCK	165
NBT□□-SL□□	SIDE LOCK HOLDER	174
NBT□□-SZF□□	ZERO FIT type SLIM CHUCK	173
NBT□□-VC□□	VC HOLDER	168
NBT□□-Z□□	TAPPER CHUCK	176
NBT□□-ZL□□	TAPPER CHUCK	176
NBT□□-ZMAC□□	ZMAC BORING ARBOR	177
NC5-□□-□□	NC5 TOOLING	193
NC5-□□-BAC□□	BALANCE CUT BAC BORING ARBOR for LARGE DIA.	205
NC5-□□-C□□	MULTI-LOCK MILLING CHUCK	195
NC5-□□-CZF□□	ZERO FIT type MILLING CHUCK	200
NC5-□□-FMA□□	FACE MILL ARBOR	206
NC5-□□-GSK□□	HIGH SPEED SLIM CHUCK	
NC5-□□-MTA□□	MORSE TAPER ADAPTER A type	202
NC5-□□-NPU□□	NC DRILL CHUCK	201
NC5-□□-PFL□□	PF MASTER HOLDER	
NC5-□□-Q□□	BASE HOLDER for MODULAR type	206
NC5-□□-RAC□□	BALANCE CUT RAC BORING ARBOR	204
NC5-□□-RAC□□	BALANCE-CUT RAC BORING ARBOR for LARGE DIA.	205
NC5-□□-SCA□□	STUB SRBOR	202

NC5-□□-SK□□	SLIM CHUCK	197
NC5-□□-SL□□	SIDE LOCK HOLDER	201
NC5-□□-SZF□□	ZERO FIT type SLIM CHUCK	200
NC5-□□-TB	TEST BAR	207
NC5-□□-VC□□	VC HOLDER	199
NC5-□□-VMC□□	VEGA CHUCK	199
NC5-□□-Z□□	TAPPER CHUCK	202
NC5-□□-ZMAC□□	ZMAC BORING ARBOR	203
BT- NC5-	DREAM-CUT HOLDER	
BT- NC5-CS	DREAM-CUT HOLDER for CENTRE THROUGH	
BT- NC5-F	DREAM-CUT HOLDER for FLANGE THROUGH	
NC5T-□□-	ATTACHMENT for #50 DREAM-CUT HOLDER	
NC5TS-□□-	ATTACHMENT for #40 DREAM-CUT HOLDER	
NCD	CENTERING DRILL	
NCL-BT□□	TOOL CLAMPER	134
NCM	MORSE TAPER SHANK NC SENSOR REAMER for Through Hole	253
NCS	STRAIGHT SHANK NC SENSOR REAMER for Through Hole	253
NCS-F	STRAIGHT SHANK NC SENSOR REAMER for Stepped Hole	253
NIT□□-□□	2 Lock Tooling for IT	189
NIT□□-C□□	MULTI-LOCK MILLING CHUCK	189
NIT□□-FMA□□	FACE MILL ARBOR	192
NIT□□-FMH□□	FACE MILL ARBOR	192
NIT□□-MDSK□□	MAJOR DREAM HOLDER	191
NIT□□-MMC□□	MINI-MINI CHUCK	190
NIT□□-SK□□	SLIM CHUCK	190
NIT□□-VC□□	VC HOLDER	191
NK	STRAIGHT COLLET WITH AXIAL ADJUSTMENT	31
NMP	MICRO TOOL PRESETTER	
BT/IT- NPU□□	NC DRILL CHUCK	45
BT/IT- NPU□□C	NC DRILL CHUCK for CENTRE THROUGH	106
BT/IT- NPU□□F	NC DRILL CHUCK for FLANGE THROUGH	108
NPUL	SPANNER for NC DRILL CHUCK	45
NQM□-□□	NON STOP CHUCK	
BT/IT- NR	AIR MOTOR SPINDLE TOOL	113
NST	CNC ROTARY TABLE	
NST-□□HP	CONVENTIONAL TILTING TABLE	
NSVX	CNC ROTARY TABLE	
NSVZ	CNC ROTARY TABLE	
NTP	TOOL PRESETTER	137
BT/IT- NX□□	HIGH SPEED SPINDLE SPEEDER	112
NX□□-STB	STOPPER BLOCK for NX	112
NZ	STRAIGHT SHANK TAPPER CHUCK	56
O		
OJK□-□	STRAIGHT COLLET for OIL HOLE	
OK	OK SHANK STRAIGHT COLLET for OIL HOLE	111
OKE	OK SHANK STRAIGHT COLLET for OIL HOLE	111
OK□□-MT	OK SHANK MORSE TAPER SLEEVE for OIL HOLE	111
OK□□-SK	OK SHANK SLIM CHUCK for OIL HOLE	111
ONK□-□	STRAIGHT COLLET for OIL HOLE	
BT/IT- OZL□□	AUTO DEPTH CONTROL TAPPER for OIL HOLE TAP	110
P		
P-□□	MANUAL TAIL STOCK	CNC
PB-□□	PNEUMATIC TAIL SPOCK for MULTI SPINDLES	CNC
PBA-□□	PNEUMATIC/HYDRAULIC TAIL STOCK	CNC
PC-□	CENTRE for TAIL STOCK	CNC
PE	PRO-END MILL	113
PE-T	TIP CLAMP WRENCH for PE	113
PF-RDSS	STRAIGHT SHANK PF RADICAL REAMER	246
PF-RMSS	STRAIGHT SHANK PF RADICAL MILL REAMER	246
PFL	PRESS FIT STAND	
BT/IT- PFL	PFL MASTER HOLDER	
PFL□-□□	PFL SHANK TOOL	
PFO	PUSH OUT BAR	
PMK□-□	COLLET for MINI-MINI CHUCK	33
BT/IT- PMH□-□	PMH MICRO HOLDER	
PMH□-TO	REMOVAL FIXTURE for PMH MICRO HOLDER	
PS	PULL STUD	261
PS-□-NC5-85	PULL STUD for #50 DREAM-CUT HOLDER	
BT/IT- PX□□	PX type HIGH SPEED SPINDLE SPEEDER	112
Q		
BT/IT- Q□□	BASE HOLDER for MODULAR type	85
Q□□-BCB	MODULAR type BCB BORING HEAD	88
Q□□-DJ	MODULAR type DJ BORING HEAD	83
Q□□-RAC	MODULAR type BALANCE CUT RAC BORING HEAD	69
Q□□-ZMAC	MODULAR type ZMAC BORING HEAD	77
Q□□-ZMAC-AA	MODULAR type HIGH SPEED ZMAC BORING HEAD	77
R		
R-□	CROLL CHUCK	CNC
BT/IT- RAA□□	SPECIAL DESIGNED BORING ARBOR	82

□□-RAC□□	BALANCE CUT BORING HEAD	69
BT/IT-RAC□□-□□	BALANCE CUT RAC BORING ARBOR	63
BT/IT-RAC□□-□□A	BALANCE CUT RAC BORING ARBOR	65
BT/IT-RAC□□-□□E	BALANCE CUT RAC BORING ARBOR	67
BT/IT-RAC□□-□□K	BALANCE CUT RAC BORING ARBOR	61
BT/IT-RAC□□□	BALANCE CUT RAC BORING ARBOR for LARGE DIA.	71
□□-RAC□□-B	BALANCE CUT RAC BASE	70
BT/IT-RAK	BALANCE CUT BORING ARBOR for LARGE DIA.	72
RCC	BALANCE CUT RAC CARTRIDGE	70
RCC	BALANCE CUT RAC CARTRIDGE for LARGE DIA.	72
RPC	BALANCE CUT PLATE for LARGE DIA.	72
RDSS	STRAIGHT SHANK PF RADICAL REAMER	246
RMSS	STRAIGHT SHANK PF RADICAL MILL REAMER	246
RNS-F	RIGHT HAND HELICAL REAMER for Blind Hole	254
RN□□-□□	AWC JIG HOLDER	CNC
BT/IT-RN□□	AWCFINGER	CNC
ROD□□	HEIDENHAIN ROTARY ENCODER	CNC
RON□□	HEIDENHAIN ROTARY ENCODER	CNC
RSS-F	RIGHT HAND HELICAL REAMER for Blind Hole	254
RXS-F	RIGHT HAND HELICAL REAMER for Blind Hole	254
R□	COPPER PIN for RAC UNIT	83
S		
S□□-BCBX□□	STRAIGHT SHANK DEEP HOLE BORING BAR	90
S□□-C	STRAIGHT SHANK MILLING CHUCK	31
S□□-COMZ	COMBAT Z DRILL	255
S□□-PE	STRAIGHT SHANK PRO-END MILL	103
S□□-PF	STRAIGHT SHANK PRESS FIT TOOL	
S□□-SK□□	STRAIGHT SHANK SLIM CHUCK ULTRA LONG type	40
S□□-UMT	STRAIGHT SHANK UNIVERSAL MICRO TOUCH	127
S□□-UMTX	STRAIGHT SHANK UNIVERSAL MICRO TOUCH	128
S□□-ZMACX	STRAIGHT SHANK DEEP HOLE ZMAC BORING BAR	90
SC	INSERT TIP	68
BT/IT-SCA□□	STUB ARBOR	104
BT-SK□□	SLIM CHUCK	37
BT-SK□□C	SLIM CHUCK for CENTRE THROUGH	105
BT-SK□□CF	SLIM CHUCK for CENTRE/FLANGE THROUGH	105
BT-SK□□F	SLIM CHUCK for FLANGE THROUGH	107
SK□-□	SLIM CHUCK COLLET	39
SK□-□A	A type SLIM CHUCK COLLET	39
SK□-□P	HIGH PRECISION SLIM CHUCK COLLET	39
SKG□□	ADJUST SCREW for SLIM CHUCK	43
SKJ□□-□□	CAP for J type NUT for SLIM CHUCK	43
SKJ□□-□□C	CAP with O ring	43
SKJL	SPANNER for J type NUT	43
SKN□	NUT for SLIM CHUCK	43
SKN-□B	TIN BEARING NUT for SLIM CHUCK	43
SKN-□B (GH)	TIN BEARING NUT for SLIM CHUCK (GH HANDLE)	43
SKN-□BJ	J type TIN BEARING NUT for SLIM CHUCK	43
SKN-□BJ (GH)	J type TIN BEARING NUT for SLIM CHUCK (GH HANDLE)	43
SKN-□J	J type NUT for SLIM CHUCK	43
SKL	SPANNER for SLIM CHUCK	43
BT/IT-SK□□□	SLIM CHUCK type OIL HOLE HOLDER	111
SKR	COLLET EXTRACTOR for SLIM CHUCK	39
BT/IT-SL□□C	SIDE LOCK HOLDER for CENTRE THROUGH	106
BT/IT-SL□□F	SIDE LOCK HOLDER for FLANGE THROUGH	108
BT/IT-SLA□□	SIDE LOCK HOLDER A type	46
BT/IT-SLB□□	SIDE LOCK HOLDER B type	46
BT/IT-SLO□□	SIDE LOCK type OIL HOLE HOLDER	111
BT/IT-SMA□□	SHELL END MILL ARBOR	
BT/IT-SMB□□	SHELL END MILL ARBOR	
BT/IT-SMS□□	SHELL END MILL ARBOR	102
SP□□-□□	SPACER for MODULAR type	86
SP□□-□□-A1	SPACER for MODULAR type (DEEP HOLE)	86
SRI-□	ROTARY SUPER INDEX	
SRM	MORSE TAPER SHANK TOUGH-CUT SKILL REAMER for Through Hole	251
SRM-F	MORSE TAPER SHANK TOUGH-CUT SKILL REAMER for Stepped Hole	252
SRS	STRAIGHT SHANK TOUGH-CUT SKILL REAMER for Through Hole	251
SRS-F	STRAIGHT SHANK TOUGH-CUT SKILL REAMER for Stepped Hole	252
ST□□-COMZ□□	COMBAT Z DRILL	255
ST□□-ZT□□	TAPPER CHUCK for NC LATHE	
STH□□-SK□□	SLIM CHUCK for NC LATHE	
SV-□□	SOLID VICE	
SX	STRAIGHT SHANK CARBIDE BROACH REAMER for STRAIGHT HOLE	249
SY	CENTERING HOLDER	132
BT-SZF□□	ZERO FIT type SLIM CHUCK	120
S.LM□-□	LIVE CENTRE set	
S.MA□□-□□	HORIZONTAL CUTTER ARBOR set	
S.MCA□□F-□□	NATIONAL TAPER MILLING chuck set	
S.MCM□-□□	MORSE TAPER MILLING CHUCK set	
S.MHA□-□	QUICK CHANGE HOLDER set	
S.N-□-□	MACHINE VICE	
S.NQMM□-□□	NON STOP CHUCK set	

T		
T□	TIP CLAMP HANDLE	93
T□□U-AHC□□	CONVENTIONAL ANGULAR HEAD	
T□□U-AHK□□	CONVENTIONAL ANGULAR HEAD	
T□□U-AHT□□	CONVENTIONAL ANGULAR HEAD	
T□□U-DAC□□	CONVENTIONAL DOUBLE CUT BORING ARBOR	
T□□U-DJ□□	CONVENTIONAL DJ BORING HEAD	
T□□U-NX□□	CONVENTIONAL SPINDLE SPEEDER	
T□□U-Q□□	CONVENTIONAL BASE HOLDER for MODULAR type	
T□□U-RAC□□	CONVENTIONAL BALANCE CUT BORING ARBOR	
T□□U-ZMAC□□	CONVENTIONAL ZMAC BORING BAR	
T	REDUCTION SLEEVE	137
TAT□□	SUPPORT TABLE	CNC
BT/IT-TB□□	TEST BAR	133
NC5T-TBC□□	TURBINE BLADE HOLDER	
TCC-□□	HYDRAULIC UNIT	CNC
TCL-□□GH	TOOL CLAMPER for HSK	222
TMS	TMS SYSTEM	138
TN	REDUCTION SLEEVE	136
BT/IT-TP	TOUCH POINT	129
TP-□□	STRAIGHT SHANK TOUCH POINT	129
BT/IT-TSA□□	SLEEVE for NT40 TOOL	48
TT□□-MT□□	QUICK CHANGE type TAPER SLEEVE ADAPTER	
TT□□-DJ□□	QUICK CHANGE type DJ BORING HEAD	
TT□□-Q□□	QUICK CHANGE type BASE HOLDER for MODULAR type	
TT□□-RAC□□	QUICK CHANGE type BALANCE CUT RAC BORING ARBOR	
TT□□-ZMAC□□	QUICK CHANGE type ZMAC BORING ARBOR	
TW	TOOL WAGON	134
TWP	REDUCTION BUSH	134
U		
UDS-□	UNIVERSAL MICRO STAND	130
BT/IT-UMS	UNIVERSAL MICRO SENSOR	127
BT/IT-UMT	UNIVERSAL MICRO TOUCH	127
BT/IT-UMTX	UNIVERSAL MICRO TOUCH	128
V		
VBA-□□	AIR TO AIR BOOSTER	CNC
BT-VC□□	VC HOLDER	34
VCG□-□	ADJUST SCREW for VC HOLDER	34
VCK□-□	COLLET for VC HOLDER	34
VMK□-□J	J type COLLET for MINI-MINI CHUCK	33
VMCL□-□	WRENCH for DREAM-CUT HOLDER	
VMK□-□	COLLET for MINI-MINI CHUCK	32
VMK□-PF	PRESS FIT TOOL for MINI-MINI CHUCK	
VML-□	COLLET REMOVAL FIXTURE for VEGA CHUCK	199
W		
W-□	STEPPED GUIDE PIECE	CNC
X		
X-□	CHUCK PLATE	CNC
Y		
Y□□-□□	CENTERING BAR	
Z		
BT/IT-Z□□	FLOATING TAPPER CHUCK	50
BT/IT-ZH□□	SYNCHRONIZED TAPPING HOLDER	55
ZK□□	ZK TAP COLLET (ISO, IMPERIAL, DIN)	55
ZKG□□	ONE TOUCH TAP COLLET	51
ZKG□□-L	LONG SIZE ONE TOUCH TAP COLLET	53
ZKN□□	ZKN TAP COLLET (JIS)	52
BT/IT-ZL□□	AUTO. DEPTH CONTROL TAPPER CHUCK	49
ZM□-□□	CONVENTIONAL TAPPER CHUCK	
□□-ZMAC□□	ZMAC BORING HEAD	75
□□-ZMAC□□R	ZMAC BORING HEAD	75
□□-ZMAC□□-AA	HIGH SPEED ZMAC BORING HEAD	76
□□-ZMAC□□R-AA	HIGH SPEED ZMAC BORING HEAD	76
BT/IT-ZMAC□□	ZMAC BORING BAR	71
BT/IT-ZMAC□□R	ZMAC BORING BAR	73
BT/IT-ZMAC□□-AA	HIGH SPEED ZMAC BORING BAR	72
ZMK□-□	TAP COLLET WITHOUT TORQUE CONTROL	56
BT/IT-ZP□□	AUTOMATIC OIL SUPPLY HOLDER	149
ZQ□□-□□	TAPPER CHUCK for NON STOP	
ZR□□-□□	AUTO. REVERSING TAPPER CHUCK	
BT/IT-ZR□□	AUTO. REVERSING TAPPER CHUCK	54
ZRM	SHANK for AUTO. REVERSING TAPPER CHUCK	

Code No. of Stop Production / Sales

A	
ANQ	ON NON STOP TOOL
B	
BT/IT-BCB□□	MICRO CUT BORING BAR (SOLID type)
BT/IT-BRB□□	RING type BORING BAR
BS50-□□	MAS Straight Shank TOOL
BT50T-□□	TOOL for TOSHIBA TURNING CENTRE
BTP50-□□	TOOL for SNK BOTTLE GRIP SHANK
BT/IT-BL□□	BALANCE CUT BORING BAR
BT/IT-LB□□	LB ARBAR for LARGE DIA.
C	
CAT30S-□□	TOOL for MAKINO SEIKI
CBT□□-□□	COMBINATION TOOL
CG	GERMAN COOLANT NOZZLE
D	
BT/IT-DAC□□	DOUBLE CUT BORING BAR
DCD-□□	TOOL for HITACHI DRILLING CENTRE
DK□□-□□	DRILL MATRE COLLET
DS□-□□	DS type BORING HEAD
BT/IT-DW□□	DOUBLE ANGLE CHUCK (DRILL MATE CHUCK)
E	
EBA-□□-□□	NATIONAL TAPER BCB BORING BAR
EBK-□□-□□	Straight SHANK BCB BORING BAR
EBM-□□-□□	MORSE TAPER BCB BORING BAR
EBR-□□-□□	CENTURY TAPER BCB BORING BAR
EBT-□□-□□	QUICK CHANGE type BCB BORING BAR
H	
HA-□□-□□	FLANGE type QUICK CHANGE HOLDER
BT/IT-HC□□	HYDRAULIC CHUCK
HNA-□□	TOOL for HITACHI (1-8UNC) BOYTTLER GRIP SHANK
HNB-□□	TOOL for HITACHI (1-8UNC) BOYTTLER GRIP SHANK
HNC-□□	TOOL for HITACHI (M24) BOYTTLER GRIP SHANK
HSK□□-NC5-	DREAM CUT HOLDER
H□□U(M)-□□	FLANGE type QUICK CHANGE TOOL
J	
BT/IT-JB	JIG BORING HEAD
BT/IT-JBD	JIG BORING HEAD
L	
LB	LB ARBOR for LARGE DIA.
L□□-NPU□□	DRILL CHUCK for NC LATHE
M	
MHP□-□□	MASTER BORING HEAD
MC□□-□□	Straight SHANK MILLING CHUCK (OLD Code No.)
MPA-□□	TOOL for MITSUBISHI BOTTLE GRIP SHANK
MTO	MOT SLEEVE for OIL HOLE HOLDER
N	
NC□□-□□	Adjustable Straight SHANK MILLING CHUCK
ND□□-JTA	Adjustable DRILL CHUCK ARBOR
NEB□□-□□	Adjustable Straight SHANK BCB BORING BAR
NG-□	GERMAN STAND
NK□□-MT□□	Adjustable MORSE TAPER COLLET
O	
ON□□	ON ONON STOP TOOL
P	
PC□□	Straight SHANK PRO-CUT ENDMILL
BT/IT-PC□□	Straight SHANK PRO-CUT ENDMILL
R	
RH□□-BRB□□	MICRO CUT BORING BAR for LARGE DIA.
RH□□-BRS□□	SQUARE BYTE BORING BAR for LARGE DIA.
S	
BT/IT-SC□□	SC SLIM CHUCK
SC□-□	SC SLIM CHUCK COLLET
BT/IT-SKZ□□	SLIM CHUCK for TAP with SQUARE HOLE
SKZ□-□	SLIM CHUCK COLLET for TAP with SQUARE HOLE
SQ□□×□□	SQUARE BYTE with MICRO CUT CARTRIDGE
ST□□-SK□□	SLIM CHUCK for SIDE LOCK type A

T	
BT/IT-TA□□	SEMI-AUTOMATIC BORING HEAD
TCL□□	TOOL CLAMPER
TCP	TOOL CLAMPING PRESETTER
TDC-□□	TOOL for FANUC DRILL MATE
BT/IT-TA□□	BT SHANK QUICK CHANGE HOLDER
U	
BT-UAR	AUTO REVERSE BFACING HEAD
UCA□□-□□	NATIONAL TAPER ULTRA MILL MILLING CHUCK
UCR□□-□□	CENTURY TAPER ULTRA MILL MILLING CHUCK
UCT□□-□□	QUICK CHANGE type ULTRA MILL MILLING CHUCK
BT-UC□□	ULTRA MILL MILLING CHUCK
UK□-□	ULTRA MILL COLLET
BT-UP□□	HIGH SPEED BASE CHUCK
UPA	UNIVERSAL BORING HEAD
UPK□-□	UPK COLLET for UP BASE CHUCK
W	
WASP	ECONOMY type PRESETTER
BT/IT-WE□□	SIDE LOCK HOLDER (USA)
RH□□-BRS□□	SQUARE BYTE BORING BAR for LARGE DIA.
S	
BT/IT-SC□□	SC SLIM CHUCK
SC□-□	SC SLIM CHUCK COLLET
BT/IT-SKZ□□	SLIM CHUCK for TAP with SQUARE HOLE
SKZ□-□	SLIM CHUCK COLLET for TAP with SQUARE HOLE
SQ□□×□□	SQUARE BYTE with MICRO CUT CARTRIDGE
ST□□-SK□□	SLIM CHUCK for SIDE LOCK type A
T	
BT/IT-TA□□	SEMI-AUTOMATIC BORING HEAD
TCL□□	TOOL CLAMPER
TCP	TOOL CLAMPING PRESETTER
TDC-□□	TOOL for FANUC DRILL MATE
BT/IT-TA□□	BT SHANK QUICK CHANGE HOLDER
U	
BT-UAR	AUTO REVERSE BFACING HEAD
UCA□□-□□	NATIONAL TAPER ULTRA MILL MILLING CHUCK
UCR□□-□□	CENTURY TAPER ULTRA MILL MILLING CHUCK
UCT□□-□□	QUICK CHANGE type ULTRA MILL MILLING CHUCK
BT-UC□□	ULTRA MILL MILLING CHUCK
UK□-□	ULTRA MILL COLLET
BT-UP□□	HIGH SPEED BASE CHUCK
UPA	UNIVERSAL BORING HEAD
UPK□-□	UPK COLLET for UP BASE CHUCK
W	
WASP	ECONOMY type PRESETTER
BT/IT-WE□□	SIDE LOCK HOLDER (USA)

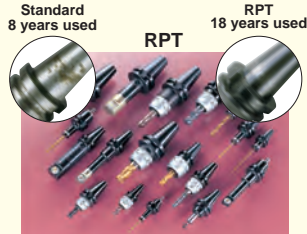
Ending of the Maintenance Duties of Nikken Controller for CNC Rotary Table

The maintenance duties of Nikken controller had been continued as long as the electric parts/boards could be supplied. But, the electric parts / boards for the controllers described below became impossible. Therefore, the maintenance duties is ended. Please exchange to new CNC rotary table with X21 controller.

- Controllers for CNC rotary table ND5000, 8000DC, 8800DC, 9000DC Ended at 2005. APR
- Controllers for NSV Index table NSV controller (M function/B function) Ended at 2005. APR

⚠ Caution for Tooling

- Please use a **NIKKEN** collet for the **NIKKEN** chucks.
- Please use a **NIKKEN** chuck for the **NIKKEN** collets. **may not be performed 100% using on the other makers chucks.**
- Please be careful not to inflict personal injury at your handling of cutting tools.
- Please clean the contact surface on a holder & cutting tool shank.
- Please pay attention to prevent from the rust at the storage. We will recommend to use **NIKKEN TOOLINGS with RPT process for rust prevention.** Due to the optical system to detect the tool existing on the tool magazine of certain machines, **NIKKEN's RP treated tooling may not be detected.** Please check your machine's specifications very carefully to avoid this problem before you purchase our RP treated tooling. The taper connection of the tool shank with RPT treatment



is more stuck than the taper connection of the tool shank without RPT treatment. Then, the unclamping force for the tool with RPT treatment is required 20% stronger than the unclamping force for the tool without RPT treatment. Please be careful to check the unclamping force of your M/C, when the tool with RPT treatment is chosen.

- Please do not use the tooling that has scratches, damaged or rusted on its taper. This may cause false accuracy readings and reduce cutting performance.
- Please pay attention not to inflict personal injury with the broken tools or swarfs.
- Please do not modify the holders by yourselves.
- Please do not touch the tool at its rotating.
- Please do not touch the tool just after machining, it might be very hot.
- Please check if the cutting tool is held with the holder properly before the machining.
- For high speed application, please use **NIKKEN HIGH SPEED TOOLINGS** or the pre-balanced toolings.

- MTA**
- Please insert the tool shank into the bore of the holder with adjusting the tang location, and hold them with facing tool front end upwards, and hit the bottom end of the holder (pull stud end) by copper hammer hardly.
 - For removal of the tool, insert a bar into tang hole and hit the bar by hammer with special care to prevent the tool from popping out.
 - Please clamp side lock screw in case of coolant through application. **For high pressure coolant through application, please use milling chuck, slim chuck or side lock holder instead of MT adapter.**

- MTB**
- Please insert the tool shank into the bore of the holder and tighten the draw bolt for the setting.
 - For removal of the tool, loosen the bolt at couple rotation and hit the bolt head by a hammer in order to remove the taper fitness, then remove the bolt.

- SCA, SCC**
- When setting of side cutter or metal saw onto the arbor, please adjust the location of the drive key.

- JTA**
- When setting drill chuck onto the arbor please put the chuck onto the arbor with adjusting the locations of male & female tapers and hit the bottom end of the holder (pull stud end) by copper hammer.
 - Please use **NIKKEN SLIM CHUCK** for high precision and high speed operation.

- NPU**
- Please insert the drill shank into the bottom, and chuck the shank with the total chucking length of **NPU**.
 - Please check the run-out accuracy before machining especially for the small diameter drill.
 - When setting the drill onto the chuck, set the drill into the chuck and tighten the chuck ring by hand then tighten the ring by attached spanner to complete.

- SL, SLA, SLB, SLS, DM**
- When setting the tool onto the holder, adjust the locations between notches or flat face of the tool shank and side lock screws, and tighten the screws completely.
 - The dimension of the flat portion of the cutter shank varies, therefore please select a proper holder according to the cutter shank dimension.
 - Code No. of the side lock holder for oil hole drill is **SLOC. OK25~OK40** collet can be used for **SLOC**.

Type	Cutter	Axial Adjustment
SL	φ 6~φ16 Drill, Endmill	—
SLA	φ20~φ42 Endmill	○
SLS*	φ 6~φ50 Endmill	—
WE	Inch Size Endmill	—
SLB	Drill Used with DSA socket	○

- *SLS is the holder for JIS B 4005 endmill or weldon type endmill.
FMA, FMB, FMC, SMA, SMB, SMS
- Please use the bolt specified by the cutter maker.
 - When setting the face milling cutter onto the arbor, insert the spigot of the arbor into the cutter bore and minimize the backlash between the drive key and the slot against the direction of rotation, then tighten the end bolt.
 - For the cutter with coolant through the body, please check the coolant pass in the arbor and the cutter before machining.
 - For high speed application, please perform the balancing operation with the cutter and insert tips fitted.

⚠ Caution for 3LOCK · 2LOCK

- Always ensure that M/C has the mechanism to confirm the perfect flange contact.
- Always ensure that M/C has the mechanism to clean the spindle flange surface.
- Please ensure that the suitable spacer is fitted on the machine spindle flange when the **3LOCK** tooling is used on the standard BT/IT/CAT spindle machine. Please do not use the **3LOCK** tooling on the standard spindle machine without the suitable thickness of the spacer.

Caution at Use

- Always ensure that swarf should not attach at the spindle flange surface of the double contact system. Generally the inside of the machining envelope is always covered with swarf. This means that there is a possibility that the flange of the tooling may collect swarf easily at the ATC. It is therefore important that the machine envelope is regularly cleaned (Clean the ATC arm, the route through which the tooling passes, the tool pot and the spindle surfaces etc.) at least every 3 months.
- The rust or fine swarf may be fitted on vacant pot inside. So, if ATC mechanism of your M/C is random pot change mechanism (the tool on the spindle is returned to the pot in which the next tool is stored), please insert the dummy tool into all vacant pots to protect this.
- Caution for centre through tool coolant application
- There are 2 types of the sealing method of the coolant at pull stud, sealing of face contact and sealing of taper contact. please choose the proper pull stud for your M/C.
- If your center through tool coolant M/C does not have the sealing mechanism at pull stud, the coolant stays inside the spindle and is sealed at BT/IT taper connection. tool can not seal the coolant at taper connection, because the taper cone of tool has the slit. Please select tooling instead.

Pulling Force of the M/C

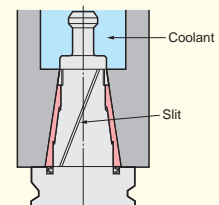
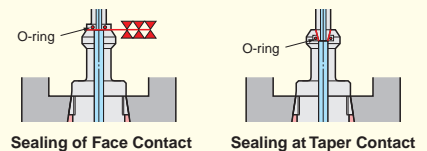
- If the pulling force of machine spindle decreases substantially, the **NIKKEN 3LOCK** tooling cannot perform 100% at its capability. We would recommend that regular inspection of the pulling force is carried out to prevent any reduction in the pulling force at an early stage. Please refer **P.185** for pulling force measurement tool.
- When the pulling force of the M/C became too low, **3LOCK** tool can not perform its capability. Please ensure the MIN. pulling force as follows:
 MBT40: 5KN
 MBT50: 15KN
- The periodical inspection of the pulling force is required.

Rust Proof Treatment

- The taper connection of the tool shank with RPT treatment is more stuck than the taper connection of the tool shank without RPT treatment. Then, the unclamping force for the tool with RPT treatment is required 20% stronger than the unclamping force for the tool without RPT treatment. Please be careful to check the unclamping force of your M/C, when the tool with RPT treatment is chosen.
- Therefore, the taper cone of **3LOCK** tool and NC5 tool is changed to without RPT treatment as standard. When the taper cone with RPT treatment is required, please add "TCRP" at the end of Code No.

M/C with Flange Trough Tool Coolant

- When the stroke of the coolant nozzle at spindle flange is not sufficient on BT/IT standard M/C, **2LOCK** tooling may not be used due to the collision. Please check the specification of your M/C.



Coilant can not be sealed at taper connection for **3LOCK** tooling. Please **2LOCK** tooling instead.

INSTRUCTION & CAUTION (MILLING CHUCK)

NIKKEN

- Wipe all dust and oil from internal bore of chuck, inside and outside of collet, and shank of cutter. Clean minute dust inside slot grooves of collet by air blow. When cleaning please use gloves and safety glasses. You are recommended to use (※) CCK collet & CKFN nut to prevent the dust or swarf from getting inside.
- After setting End Mill into collet insert them into the chuck.



- Please use End Mill of h7 tolerance shank.
- Please use End Mill with h6 shank tolerance for high speed machining.
- Clamp as much of the shank of End Mill as possible.
- Insert Collet into Chuck until the flange of collet touches the surface of the front end.

- To tighten the nose ring lightly until to contact with the the flange surface of the chuck body is ready to use. If the nose ring is contacted too strongly, it may cause the internal stress higher, and the run-out accuracy may not be accurate.

Solution

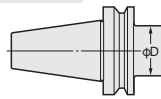
Return the nose ring just a little to tap slightly as illustration at right hand side. This operation releases the internal stress, and the run-out accuracy will be recovered. To release the internal stress is recommended for all milling chucks.



- For IT^(ISO) / CAT taper, please be careful to check the dimension "D" with your machine.

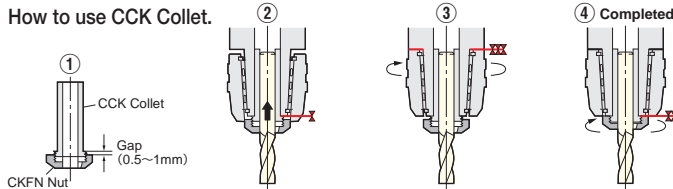


The dimension of "D" of some models are greater than the specification of your machine.



- When using CCK32-16,20,25 Collets with CKFN32T Front Nut, please set the rear slits of the Collet to the same location of the slots of the Milling Chuck.

How to use CCK Collet.



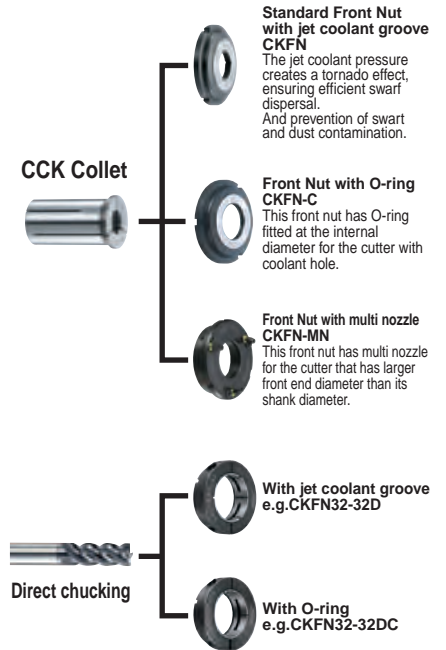
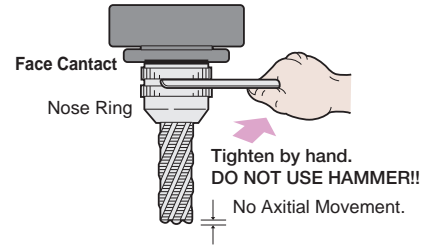
- Loosen the front nut on the collet to provide a small gap between both contact surfaces of the collet and the nut.

- Insert the collet with the cutter into the chuck until the collet flange touches the chuck front flange surface. Adjust the required length of the cutter.

- Tighten the nose ring until the nose ring contacts the chuck ground surface.

- Tighten the front nut thoroughly with CCKL Spanner (Option) until the nut flange surface contacts the chuck front flange surface. (Perfect Sealing)

- When removing the cutter: Loosen the nose ring first, then remove the collet and the cutter. For the next set up, please start from the operation ①.



INSTRUCTION & CAUTION (TiN BEARING NUT SERIES)

NIKKEN

- Always ensure that there is no damage on the internal bore of the chuck, the internal & external of the collet, and the Cutting tool shank.
- Wipe all dust from internal bore of chuck, inside and outside of collet, inside of nut and shank of cutter.

Clean minute dust inside slot grooves of collet and inside of nut by air blow. We will recommend to use J type nut to prevent swarf and dust contermination.

- Set SK Collet into SK Nut. Collet Extractor (SKR-6) is used only for SK6.
- Screw SK Nut into Slim Chuck spindle.



—Do not insert a SK Collet alone into Slim Chuck spindle.

- Insert cutting tool shank into SK Collet.



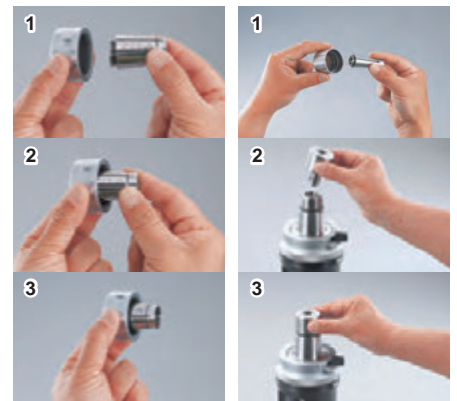
- Protection must be used to grip cutter teeth.
- Use a proper SK Collet to grip a cutter shank.
- Use "A" type SK Collet to grip a cutter with End Mill shank. Gripping range of "A" type SK Collet is h8.
- Clamp as much of the shank of cutter as possible.

- After tightening SK Nut by hand, tighten further by NIKKEN spanner.

This is the precision tool, tighten the nut with the suitable tightening torque !

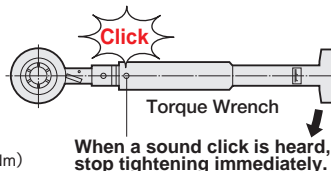
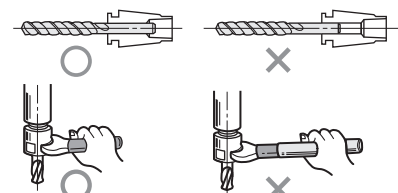


- Clamp the cutter shank as long as possible.
- Tighten the nut with the suitable tightening torque listed below. If the torque is exceeded, it may cause the breakage of a collet or a chuck itself.
- Tighten the nut slowly by the torque wrench. When the torque limiter is worked (a sound click), stop tightening immediately. Do not tighten with the torque over the torque limiter.



Slim Chuck

VC Holder



Always ensure that the slim chuck is set up on the proper fixture, e.g. NIKKEN tool clamper TCL-GH, P.222 when the nut is tightened.



Style	Cutter Dia.			
	~φ3mm	φ4~φ6mm	φ8~φ10mm	φ12mm~
SK 6	10~20	20~30		
SK10			35~45	
SK13			40~50	45~50
SK16			55~65	65~75
SK20			60~70	80~90
SK25			70~85	90~100

(Nm)

ZMAC BORING HEAD

How to preset boring diameter

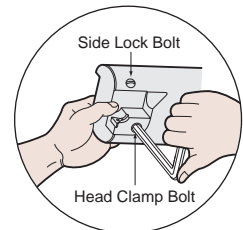
- 1) Loosen Side Lock Bolt before turning of dial ring. Preset boring diameter by turning dial ring with attached spanner.
- 2) Adjustment always has to be done in clockwise (+ direction) , and if you go beyond the required graduation, rewind the dial ring half a turn and readjust.
- 3) Tighten Side Lock Bolt after adjusting.

How to exchange Cartridges

- 1) Loosen Side Lock Bolt.
- 2) Turn dial ring in an anti-clockwise (-direction) to remove the Cartridge from the boring head.
- 3) To set new Cartridge in, insert into location hole and turn and dial ring in a clockwise (+ direction), the Cartridge will settle in gradually.

How to exchange Cartridge Heads for ZMAC42 or larger heads

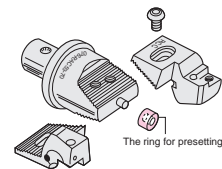
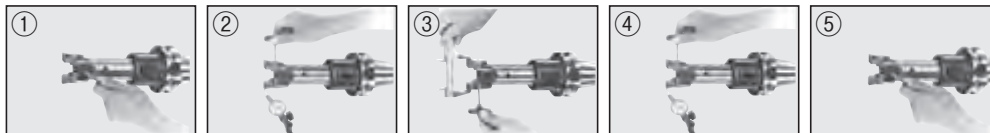
- 1) Adjust the diameter to just a little bit bigger than Min. Diameter of the Head.
- 2) Then, loosen the Head Clamp Bolt to remove the Cartridge Head.
- 3) Insert new Cartridge Head into the shaft, then tighten the Head Clamp Bolt temporary.
- 4) Loosen the Side Lock Bolt.
- 5) Turn the Dial Ring 0.2~0.3 mm to the minus direction.
- 6) Tighten the bolt by pushing the Cartridge Head strongly into the shoulder of Boring Head.
This is very important to keep Shoulder Contact !
- 7) Then, tighten the bolt completely.



RAC BALANCE CUT BORING HEAD

How to preset boring diameter

- 1) Loosen Cartridge Clamping Bolts on both sides first and tighten them slightly.
- 2) Put dial gauge at the edge of insert tip, centralize and preset the diameter at just smaller than the diameter you need with L wrench. (If you need $\phi 48$ mm boring diameter, preset them approx. $\phi 46$ mm.)
- 3) Turn the adjusting screw clockwise and extend the cartridges of both sides.
- 4) Centre the cartridges of both sides again. The difference between cartridges should be within ± 0.05 mm.
- 5) Tighten Cartridge Clamp Bolts on both sides completely.



In case of RAC Head is used for always same boring diameter such as repeating operation, the ring, which internal diameter is equal to the diameter of boss ($\phi 3$ mm) located on RAC Head top, for presetting is recommended.

DJ BORING HEAD

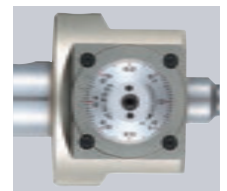
Setting of DJ Boring Bit

Select a boring bar that is suitable for the required diameter and depth from the DJ Boring Bit list. Set the Boring Bit into the head so that the insert faces the location line on the head (opposite side to the dial ring).

Following this operation, tighten the set screws for Boring Bit on the opposite side of the dial ring.

Operation of the Dial Ring

- 1) Always ensure that the locking screw for adjustment has been loosened.
- 2) Always rotate the dial ring in the same direction (+direction) .
If the desired diameter has been passed, wind off the dial by approximately 0.2mm and re-adjust.
- 3) Always tighten the locking screw after the adjustment has been completed.



INSTRUCTION & CAUTION (PULL STUD)

The guide line for pull stud tightening torques are as follows;

BT30: 20 ~ 25 N·m

BT40: 60 ~ 80 N·m

BT50: 200 ~ 250 N·m

For high precision BT30 tooling (e.g. Milling Chuck, Slim Chuck and Mini-Mini Chuck etc), the tooling completely with pull studs fitted is also available. Please contact with us to arrange this option.

MAS BT30 centre through pull stud ($\phi d2=7$ mm) cannot be recommended by its weakness due to thin profile. **When purchasing a #30 taper machining centre with centre through coolant capability, we can highly recommend a machine using the NIKKEN NC5-46 spindle.**

JIS40 type pull stud ($\phi d2=14$ mm) is highly recommended for centre through coolant machining centre instead of **MAS BT40** type ($\phi d2=10$ mm).

When pull stud without hole is used on the centre through tool coolant M/C, please use the pull stud which top surface is ground.

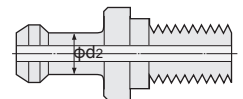
The special pull stud with O ring is required for the M/C with flange through coolant capability.

We recommend you regularly check the measurement of the pulling force to discover any problems at an early stage. Please use **NIKKEN Pulling Force Measuring Tool (CLP)** to perform this check.

Please use **NIKKEN** pull stud, do not use any pull stud which has damage marks on its draw head area or is deformed.

The pull stud is considered to consumption item and should be replaced periodically. **The guide line of replace ment is ;**

Without hole : 3 years or 150,000 times of ATC. With coolant hole : 2 years or 100,000 times of ATC.

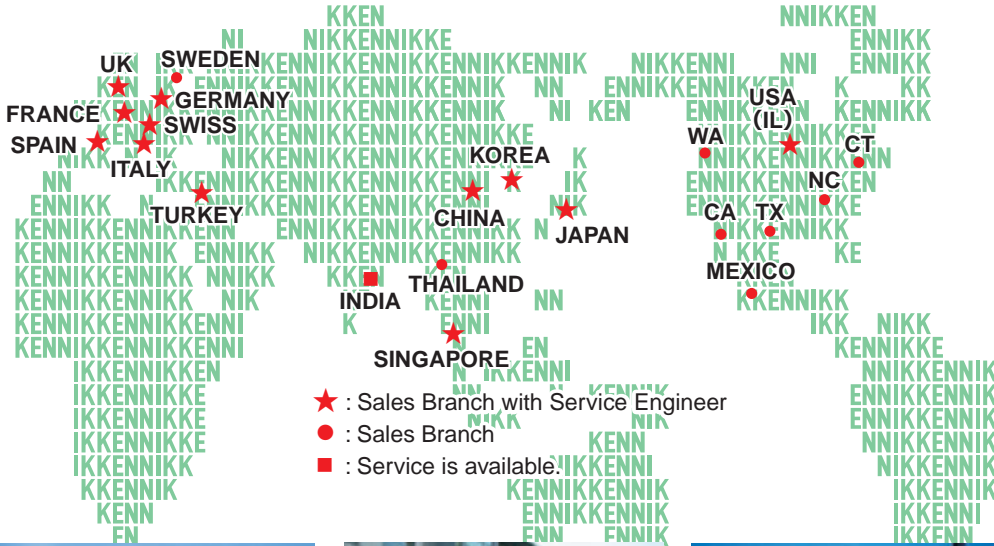


TAPER	Code No.
BT30	BT30-CLP
BT40	BT40-CLP
BT50	BT50-CLP

NIKKEN WORLD WIDE SALES BRANCH



There are overseas Sales Branches in 12 countries. Each sales branch has stocks for toolings and CNC Rotary Tables, and service engineers look after the maintenance and service operation of our products. In the other region, e.g. East-South Asia, Ozaena, South America, Africa, etc., there are some distributors. At the production line in abroad, as there are many requirements for special tools and CNC Rotary Table to suit the special specifications, please ask us or distributors for spare tools and maintenance parts in advance.



LYNDEX-NIKKEN (U.S.A.)



HERRAMIENTAS LYNDEX-NIKKEN (MEXICO)



NIKKEN EUROPE & NIKKEN U.K (UK)



NIKKEN DEUTSCHLAND (F.R.GERMANY)



PROCOMO-NIKKEN (FRANCE)



KOREA NIKKEN (KOREA)



NIKKEN SCANDINAVIA (SWEDEN)



VEGA INTERNATIONAL (ITALY)



CUTTING TOOL (SPAIN)



NIKKEN CHINA (CHINA)



NIKKEN SWITZERLAND (SWISS)



NIKKEN TURKEY (TURKEY)



SIAM NIKKEN (THAILAND)



NIKKEN ASIA (SINGAPOLE)

- ★ **U.S.A**
CA, CT, IL, NC, TX, WA
LYNDEX-NIKKEN
1468 Armour Boulevard,
Mundelein, ILLINOIS 60060
Tel.+001(847)367-4800 Fax.+001(847)367-4815
- MEXICO**
HERRAMIENTAS LYNDEX-NIKKEN S.A.de C.V.
Calle Santa Fe No. 138, House #66 Juriquilla Santa Fe
Santiago de Queretaro, Qro. Mexico, C.P.76230
Tel.+0052-55-8421-8421
- ★ **FRANCE**
PROCOMO-NIKKEN-S.A.S
6, avenue du 1er Mai-Z.A.E.Les Glaises 91127
Palaiseau Cedex
Tel.+0033(01)69.19.17.35 Fax.+0033(01)69.30.64.68
- ★ **UK**
NIKKEN KOSAKUSHO EUROPE LTD.
Precision House, Barbot Hall Industrial Estate,
Rotherham, South Yorkshire, S61 4RL
Tel.+0044(01709)366306 Fax.+0044(01709)376683
- ★ **F.R.GERMANY**
NIKKEN DEUTSCHLAND GmbH
Eisenstraße 9b, 65428 Rüsselsheim
Tel.+0049(0)6142/55060-0 Fax.+0049(0)6142/55060-60
- ★ **ITALY**
VEGA INTERNATIONAL TOOLS S.P.A
Via Asti N-9 10026-Santena(TORINO)
Tel.+0039(011)9497911 Fax.+0039(011)9456380
- ★ **SWITZERLAND**
NIKKEN SWITZERLAND AG
Sumpfstrasse 32 CH-6300 Zug
Tel.+0041(0)41-748-5000 Fax.+0041(0)41-748-5001

- SCANDINAVIA**
SWEDEN
NIKKEN SCANDINAVIA AB
Bultgatan 13b, 44240 Kungälv
Tel.+0046(0)303-440600 Fax.+0046(0)303-58177
- ★ **SPAIN & PORTUGAL**
CUTTING TOOL S.L
PORTUETXE 16, BARRIO IGARRA
E-20018 DONOSTIA-SAN SEBASTIAN
Tel.+0034 902-82 00 90 Fax.+0034 902-82 00 99
- ★ **TURKEY**
NIKKEN KESICI TAKIMLAR SAN. VE ULUSLARARASI TIC. A. S
E5 UZERI KUCUKYALI YANYOL IRMAK SOK.
KUCUKYALI SANAYI SITESI A BLOCK NO.5
MALTEPE 34852 ISTANBUL
Tel.+0090(0216)518-1010 Fax.+0090(0216)366-1414
- ★ **KOREA**
KOREA NIKKEN LTD.
90B-11L, Namdong Industrial Complex, 671-10, Gojan-Dong,
Namdong-Gu, Incheon 405-819 KOREA
Tel.+0082(032)763-4461 Fax.+0082(032)763-4464
- ★ **P.R.CHINA**
SHANGHAI ZHONG YAN TRADING CO., LTD.
GROUND & SECOND FLOOR, D BUILDING, NO.357
ZHAO HUA ROAD, SHANGHAI
Tel.+0086(021)6210-2506 Fax.+0086(021)6210-2083
- ★ **SINGAPORE**
NIKKEN KOSAKUSHO ASIA PTE, LTD.
268, WOODLANDS CENTRE ROAD, #03-05
WOODLANDS POINT, SINGAPORE 738931
Tel.+0065(6362)-7980 Fax.+0065(6362)-7980
- THAILAND**
SIAM NIKKEN Co., LTD.
127 Moo5 Gauwungsai-Bangturie Road Tambon Tanokkard
Ampher Muangnakhonpathom Nakhonpathom 73000 Thailand
Tel.+0066(02)178-0503 Fax.+0066(02)178-0504

★: Branch with service engineer

New Nikken facility was opened at Zhao Hua Road, Shanghai on 2004 JAN due to the Chinese business expansion. The standard items of NC tooling & CNC rotary table and each important spare parts are stocked for quick delivery.

You can access to Nikken China with Chinese, Japanese or English. Not only Chinese catalogue but also Chinese instruction manual are provided for Chinese domestic market. Our office has the show room to see and touch our products, and our presentation will be done more practically. Technical seminar of Nikken is also opened at user factory side.



上海中研贸易有限公司



Chinese engineer well trained in Japan is engaged in the service of our products. Different types of the NC controller for the CNC rotary table are provided for the trial running after repair. The most important spare parts are stocked. It is possible to stock the special spare parts of the custom-made tooling or CNC rotary table for further discussion. Please consider to make a contract of "Nikken Rotary Table Overseas Warantee Contract" for the CNC rotary table delivered to China.

The sales of nikken products through Internet is not started in China. For after service and the further maintenance, please purchase Nikken products through authorized distributors.

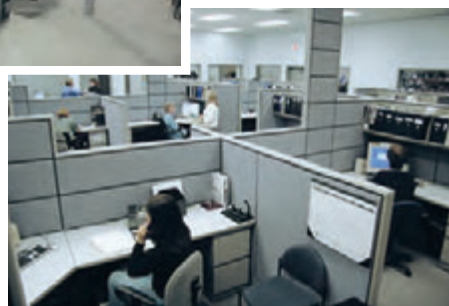
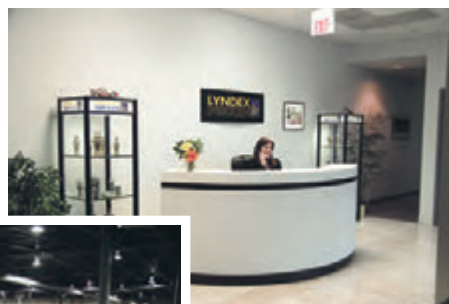
As North America's leading supplier of machine tool accessories, LYNDEX-NIKKEN is a wholly-owned subsidiary of NIKKEN Kosakusho Works., Ltd. - Japan. Backed by over a half century of experience, LYNDEX-NIKKEN sets the standard for high quality and high technology with a complete line of superior toolholders and machine tool accessories. From one source you can expect the best of both worlds: Extreme Quality and Advanced Technology.

LYNDEX-NIKKEN has a team of dedicated application and engineering staff available to advise you on your application and support our entire product line throughout the U.S., Canada, Mexico and South America. Our regional managers in Chicago, Los Angeles, Boston, Charlotte, Dallas and Seattle support our 1,000 plus distributors with machine tool accessories expertise.

LYNDEX-NIKKEN provides expert process and product consultation for even the most demanding applications with full on-demand field support and ongoing training.

North American Facility

The LYNDEX-NIKKEN North American headquarters is centrally located near Chicago Illinois. Our 50,000 sq ft. facility warehouses an inventory of over 12,000 machine tool accessories stocked for fast delivery. Over 95% of orders are shipped out same day. Our extensive inventory of products includes:



Products

- **Rotary Tables** - NIKKEN's complete line of CNC Rotary Tables are known worldwide for their wear-resistance, rigidity and high-speed rotation. NIKKEN rotary tables are built to provide high accuracy, increased production and a trouble-free long life.

- **Advanced Toolholders** - Maximize the potential of your machine tools with LYNDEX-NIKKEN's advanced toolholders.

- **Standard Toolholders** - LYNDEX-NIKKEN's complete range of quality-driven toolholding solutions are designed to meet your strictest requirements.

- **Presettters** - Our full line of Presettters are full-featured for optimum accuracy in tooling setup, measurement and inspection.



Service & Support

- Dedicated application and engineering support staff
- Support for entire product line spans the U.S., Canada, Mexico and South America
- On-demand field support and ongoing training
- Customer service and technical support staff
- Expert process and product consultation for even the most demanding applications
- Cutting trials and testing
- Service, repair and custom configuration completed on-site
- Attention to high-tech application demands, including high-speed and balanced toolholding solutions



The NIKKEN Euro Centre based in the UK was opened in 1999; from here we sell, distribute and support all products to our subsidiaries and dealers in over 20 countries around Europe. At the NIKKEN Euro Centre we take great pride in the consistent delivery of the four founding principles of our business: **Absolute Integrity, Uncompromising Quality, Unflinching Support,** and above all **“Total Commitment”** to our customers.



Product Inventory

NIKKEN Euro Centre facilities has a warehouse space of 13,000m². which holds over 50,000 individual items covering a range of some 4,000 product lines, including the latest generation of Single & Multi Axis CNC Rotary tables, thus making it the largest stock of NIKKEN products in Europe.

Our Technical Support and Training Section provides our existing customers and potential customers access to:

- A Multimedia based training facility that ensures our customers, through comprehensive training, will realize the full productivity potential of their application.
- A wealth of engineering expertise covering all aspects of application set-up, optimization and implementation that is available for the full life of the NIKKEN product.



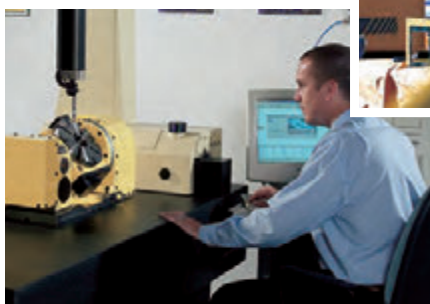
Our machining centre equipped with Testing Facilities enables us to:

- Research, develop and optimize all of our tooling systems.
- Demonstrate to our potential customers the advantages of using both NIKKEN Tooling and CNC Rotary Tables in their applications.



Our Service Department specializes in:

- Providing on-site inspections prior to rotary table repairs and refurbishment by our own NIKKEN trained service engineers.
- Providing tooling and rotary tables optimized to seamlessly integrate into any application.



Nikken Deutschland GmbH, a wholly owned subsidiary in Germany of NIKKEN Kosakusho Works, was established in 2003 to take over the sales activities of the previous distributor. Based in Russelsheim, which is a town made famous by the manufacturing complex of Opel, the company is located about 15 minutes away by car from Frankfurt airport. Germany has ranked at the top of the machine tool industry for many years, and is also the supply source of machine tools that are fuelling the significant expansion now taking place in Eastern Europe. Nikken Deutschland GmbH has its base at the centre of the huge market of Germany and Eastern Europe, and continues to broaden the range of the company's sales operations.

NIKKEN has achieved some impressive successes in Germany with its CNC rotary tables and tool holders thanks to a long sales history of the company's sales activities. A sales force consisting mainly of German personnel stands on the front line of this activity to address the sales and servicing needs of the entire country. More specifically, the company provides technical advice, repairs, aftersales support and other services to end users, distributors and machine dealers.



To enable speedy delivery of standard items in the German market and of popular products compliant with European standards, Nikken Deutschland GmbH works closely with Nikken Euro Centre to keep a full stock at its disposal. The company uses the most appropriate type of delivery in each case, including parcel post, DHL, door-to-door service and flash shipment, to meet the demands of customers.

The sales territory of Nikken Deutschland GmbH spans the vast area of eastern Europe and covers such countries as the Czech Republic, Slovakia, Austria, Russia, Poland, Hungary, Romania and Bulgaria, all countries in which Japanese companies are rapidly expanding their business. The service is not limited to sales, but engineers make on-site adjustments, repairs and service calls as well.

Nikken Deutschland GmbH has participated in and contributed to many trade shows and exhibitions held in Germany, including the EMO show, METAF, AMB and EURO MOULD. The company's fully furnished showroom is a Mecca of information to the constant stream of visitors who can inspect products and examples of machining, as well as receive application advice and technical training. They can handle NIKKEN's products for themselves, learn about the construction and capability of the CNC rotary tables, and learn about the accuracy and other features of NIKKEN's products.

A complete support organisation is in place to ensure that advice is relayed promptly by telephone and other rapid communication media, that repairs or delivery of tool holders and CNC rotary tables are carried out promptly with all due diligence, and that emergency service calls are responded to rapidly.

To make it possible to support all types of motors and controllers for NIKKEN's CNC rotary tables, the company has set up trial run equipment that accommodates many different motors, and offers a full range of accessories including tailstocks, support tables, scroll chucks and collet chucks adapted to the CNC rotary tables. The fact that NIKKEN's CNC rotary tables are endowed with outstanding durability and that a complete support service is provided instils confidence in users that the equipment will give outstanding service in the years ahead.

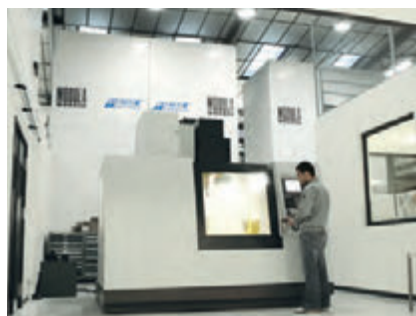
Procomo France S.A.S was established 30 years ago with the avowed intent to deliver the high-accuracy and high-quality tool holders and CNC rotary tables as well as related services, applications and after-sales servicing, into the hands of engineers in France. A major milestone in the company's history was marked in 2006 with the change of the company name to PROCOMO-NIKKEN, and the company took on a new lease of life as NIKKEN's wholly owned subsidiary in France.



In 2005, PROCOMO-NIKKEN embarked on a complete renovation of its buildings and facilities in order to make it possible for users to gain hands-on experience of NIKKEN's products in a bright and comfortable environment.



In the meeting room, which is fitted out with all the latest multimedia technology, technical seminars are regularly held so that attendees will come away with a clear understanding of NIKKEN's products and technology. The showroom is where videos of cutting operations are screened, and visitors can actually handle some of NIKKEN's products in this room as well. The machining centre, which is used for cutting trials, enables visitors to identify what makes NIKKEN's products different from those of other companies and to judge how impressive are the machining accuracy and advanced cutting capabilities of NIKKEN's products. As the top tool holder manufacturer, NIKKEN believes is that once customers have their own personal experience of the low machining noise, attractive-looking cut surfaces and uniform discharge of chips, they will be convinced that they can completely trust in and depend on the expertise and capabilities of the company.



The stocks of a large number of standard products are always on hand, enabling the products that customers need to be delivered in the shortest possible time. The NIKKEN Euro Centre and PROCOMO-NIKKEN retain constant and close contact; together they take on the challenge of how to machine products in a more rationalized manner, in a shorter time and to a higher accuracy so that France's engineers can meet every need of the French marketplace.

NIKKEN has already earned an enviable reputation in the global marketplace for the high accuracy and outstanding wear resistance of the company's CNC rotary tables. PROCOMO-NIKKEN has a team of five engineers dedicated full-time to providing users with application support prior to placing orders for tool holders and CNC rotary tables and to carrying out the preparation for shipment, education and training programs, maintenance and repairs, and servicing. This support network delivers a wide range of services, while willingly taking up the challenge of coming to grips with new applications.



NIKKEN KOSAKUSHO WORKS, LTD. OSAKA, JAPAN.

5-1, 1-chome, Minamishinden, Daito-shi, Osaka-fu, Japan. Telephone:072-869-5820 Telefax:072-869-6220

U.S.A

CA, CT, IL, NC, TX, WA

LYNDEX-NIKKEN

1468 Armour Boulevard,
Mundelein, ILLINOIS 60060
Tel.+1-847-367-4800 Fax.+1-847-367-4815

MEXICO

HERRAMIENTAS LYNDEX-NIKKEN S.A.de C.V.
Calle Santa Fe No. 138, House #66 Juriquilla Santa Fe
Santiago de Queretaro, Qro. Mexico, C.P.76230
Tel.+52-55-8421-8421

FRANCE

PROCOMO-NIKKEN S.A.S

6, avenue du 1er Mai-Z.A.E.Les Glaises 91127
Palaiseau Cedex
Tel.+33-(0)-1-69.19.17.35 Fax.+33-(0)-1-69.30.64.68

UK

NIKKEN KOSAKUSHO EUROPE LTD.

Precision House, Barbot Hall Industrial Estate,
Rotherham, South Yorkshire, S61 4RL
Tel.+44-(0)-1709-366306 Fax.+44-(0)-1709-376683

F.R.GERMANY

NIKKEN DEUTSCHLAND GmbH

Eisenstraße 9b, 65428 Rüsselsheim
Tel.+49-(0)-6142-550600 Fax.+49-(0)-6142-550600

ITALY

VEGA INTERNATIONAL TOOLS S.P.A

Via Asti N°9 10026-Santena(TORINO)
Tel.+39-011-9497911 Fax.+39-011-9456380

SWITZERLAND

NIKKEN SWITZERLAND AG

Sumpfstrasse 32-CH-6300-Zug
Tel.+41-(0)-41-748-5000 Fax.+41-(0)-41-748-5001

SCANDINAVIA SWEDEN

NIKKEN SCANDINAVIA AB

Bultgatan 13b, 44240 Kungälv
Tel.+46-(0)-303-440-600 Fax.+46-(0)-303-58177

SPAIN & PORTUGAL

CUTTING TOOLS S.L

PORTUETXE 16, BARRIO IGARRA
E-20018 DONOSTIA-SAN SEBASTIAN
Tel.+34-(0)-902-820090 Fax.+34-(0)-902-820099

TURKEY

NIKKEN KESICI TAKIMLAR SAN. VE ULUSLARARASI TIC. A. S

E5 Uzeri Kucukyali Yanyol Irmak Sok.
Kucukyali Sanayi Sitesi A Blok No:5 Maltepe 34852 Istanbul
Tel.+90-(0)-216-518-1010 Fax.+90-(0)-216-366-1414

KOREA

KOREA NIKKEN LTD.

90BL-11L, Namdong Industrial Complex, 671-10, Gojan-Dong,
Namdong-Gu, Incheon 405-819
Tel.+82-(0)-32-763-4461 Fax.+82-(0)-32-763-4464

P.R.CHINA

SHANGHAI ZHONG YAN TRADING CO., LTD.

GROUND & SECOND FLOOR, D BUILDING, No. 357
ZHAO HUA ROAD, SHANGHAI
Tel.+86-(0)-216210-2506 Fax.+86-(0)-216210-2083

SINGAPORE

NIKKEN KOSAKUSHO ASIA PTE, LTD.

268, WOODLANDS CENTRE ROAD, #03-05
WOODLANDS POINT, SINGAPORE 738931
Tel.+65-6362-7980 Fax.+65-6362-7980

THAILAND

SIAM NIKKEN Co., LTD.

127 Moo5 Gauwungsai-Bangturie Road Tambon Tanokkard
Ampher Muangnakhonpathom Nakhonpathom 73000 Thailand
Tel.+66(02)178-0503 Fax.+66(02)178-0504

<http://www.nikken-kosakusho.co.jp>
e-mail : export@nikken-kosakusho.co.jp

■Please give your order to the following agent.

D.HB.10

●Specifications are subject to change without notice.